

FACELIFT

COLLECTION

PRICE LIST • MARCH 1, 2025

T R I N I T Y

FACELIFT FEATURES

ALL PRODUCTS ARE MODULAR, REPLACEABLE, RECYCLABLE AND RENEWABLE. ALL UPHOLSTERY ATTACHES WITH VELCRO BRAND HOOK AND LOOP FASTENERS. NO TOOLS ARE NEEDED TO RENEW ANY UPHOLSTERY COMPONENTS. SIMPLY PEEL OFF AND REPLACE. SAFE-T-GUARD® ANTIMICROBIAL WOOD FINISH TOP COAT IS STANDARD ON EXPOSED WOOD. ANTIMICROBIAL BARRIER FULLY ENCAPSULATES THE SEAT, BACK AND ARMS. THE HYBRID FRAME IS MADE FROM RECYCLED STEEL, FSC APPROVED HARDWOOD AND PLYWOOD. SELECTED BARIATRIC MODELS ARE RATED 500 TO 1000 POUNDS. ALL MAINTENANCE CAN BE PERFORMED TOTALLY ON-SITE. ALL COMPONENTS CAN BE REPLACED INDEPENDENTLY, INCLUDING:

- UPHOLSTERY COVERS
- SEAT AND BACK CUSHIONS
- SEAT SUSPENSION SYSTEM
- ALL FRAME COMPONENTS

FLAMMABILITY

UNLESS OTHERWISE SPECIFIED, FOAM USED IN ALL TRINITY FURNITURE INCORPORATED SEATING PRODUCTS COMPLIES WITH CALIFORNIA TECHNICAL BULLETIN 117. PLEASE CONTACT CUSTOMER SUPPORT IF COMPLIANCE IS REQUIRED FOR THE OTHER FIRE CODES. INCLUDING:

BOSTON FIRE CODE**CALIFORNIA TECHNICAL BULLETIN 133****NEW YORK PORT AUTHORITY****SPECIFICATIONS**

UPHOLSTERY FRAMES ARE PLYWOOD AND HARDWOOD. STEEL SEAT FRAME. SEAT IS HIGH DENSITY POLYURETHANE OVER RUBBER WOVEN POLYPROPYLENE STRAPS. BACK IS HIGH DENSITY POLYURETHANE OVER SINUOUS WIRE. ANTI-MICROBIAL MOISTURE BARRIER STANDARD. EXPOSED WOOD IS SOLID MAPLE. ALL ITEMS ARE PRODUCED TO PRICE LIST SPECIFICATIONS. WE RESERVE THE RIGHT TO MAKE MODIFICATIONS AND IMPROVEMENTS WITHOUT PRIOR NOTICE. ALL DIMENSIONS SHOWN ARE APPROXIMATE AND MAY VARY DUE TO COVER BEING USED.

FACELIFT WARRANTY

TRINITY WARRANTS ALL FACELIFT PRODUCTS FOR THE LIFE OF THE PRODUCT AGAINST MANUFACTURING AND FACTORY DEFECTS, EXCLUDING COVERING MATERIALS, UNDER NORMAL SINGLE SHIFT SERVICE FOR ORIGINAL PURCHASER. DURING THIS PERIOD TRINITY FURNITURE, AT OUR OPTION, WILL REPLACE, REPAIR OR RETURN THE PURCHASE PRICE OF ANY MERCHANDISE THAT, UPON OUR INSPECTION, IS DEEMED TO BE DEFECTIVE, THIS CONSTITUTES THE SOLE AND EXCLUSIVE REMEDY TO THE CUSTOMER. DAMAGES, RESULTING FROM FREIGHT, CLAIMED OR UNCLAIMED, FROM ACCIDENT, ALTERATION, TAMPERING, MISUSE, NEGLIGENCE OR ABUSE VOIDS THIS WARRANTY. IN THE EVENT ANY PRODUCT HAS TO BE RETURNED TO THE FACTORY FOR VERIFICATION OF A COMPLAINT, IT MUST BE SHIPPED PREPAID AND INCLUDE WRITTEN INFORMATION CONTAINING THE NAME OF THE ORIGINAL PURCHASER, ORIGINAL INVOICE NUMBER, AND A COPY OF THE ORIGINAL PURCHASE ORDER MUST BE PROVIDED. BECAUSE OF NATURAL VARIATIONS ON MATERIALS OVER WHICH TRINITY FURNITURE INC HAS NO CONTROL, THIS WARRANTY DOES NOT EXTEND TO COLOR, GRAIN, OR TEXTURE OF WOOD, OR UPHOLSTERY COVER. THIS WARRANTY IS APPLICABLE ONLY TO THOSE PARTS ACTUALLY MANUFACTURED BY TRINITY FURNITURE. FOR PURCHASED COMPONENT PARTS, WE WILL APPLY EXACTLY THE SAME WARRANTY THIS IS EXTENDED TO US BY OUR SUPPLIER. TRINITY FURNITURE SHALL NOT BE LIABLE FOR CONSEQUENTIAL OR INCIDENTAL DAMAGES ARISING FROM ANY PRODUCT DEFECT.

MADE IN AMERICA

ALL FURNITURE IS PROUDLY MADE IN THE UNITED STATES OF AMERICA.

ENVIRONMENTAL SUSTAINABILITY**ALL TRINITY FURNITURE PRODUCTS HAVE LEVEL 1 CERTIFICATION**

THE BUSINESS INSTITUTIONAL FURNITURE MANUFACTURERS ASSOCIATES (BIFMA) LEVEL STANDARD IS TO PROVIDE MEASURABLE MARKET-BASED DEFINITIONS OF PROGRESSIVELY MORE SUSTAINABLE FURNITURE BY ESTABLISHING PERFORMANCE CRITERIA THAT ADDRESS ENVIRONMENTAL AND SOCIAL ASPECTS THROUGHOUT THE SUPPLY CHAIN.

THIS STANDARD PROVIDES A PATHWAY TOWARDS SUSTAINABILITY BY ESTABLISHING MEASURABLE CRITERIA FOR MULTIPLE LEVELS OF ACHIEVEMENT AND/OR PERFORMANCE. IT ADDRESSES PRODUCT BASED CHARACTERISTICS IN THE GENERAL AREA OF MATERIALS, USE OF ENERGY, HUMAN AND ECOSYSTEM HEALTH, AND SOCIAL RESPONSIBILITY IMPACTS.



Facelift Replay

GUEST / LOUNGE / TANDEM

Effective: March 1, 2025

T R I N I T Y

Date:

Page:

Modification:

Description:

DESCRIPTION:

- Upholstery Frames: Steel, Plywood & Hardwood
- Seat: High Density Polyurethane Foam Over Strap Webbing
- Back: High Density Polyurethane Foam Over Sinuous Wire Springs
- Upholstered Covers: Attached w/ Velcro / Removable For Maintenance
- Antimicrobial Moisture Barrier Fully Encapsulates All Foam Areas
- Double Needle Stitching Standard (Welting Optional - No Charge)
- Exposed Wood Legs: Solid Hardwood / Removable For Maintenance
- Leather Upholstery Not Available
- Lifetime Warranty

OPTIONS:

- RWAC-1 Solid Wood Arm Caps (Set Of 2)\$374
- RPAC-1 Black Polyester Arm Caps (Set Of 2).....\$484
- ASL Aluminum Square Legs (Set Of 4).....\$382
- PM1 Power/Data Module (1-Power / 1-USB 2 Port Simplex Charger)\$859
- PM2 Power Module (1-Power).....\$238
- USB-1 Dual Charging USB\$238
- Feather Down & Polyester Pillows Available (See Page 5)
- Specify Exposed Wood Finish (See Page 6)
- Tablet Arm / Cup Holder Options (See Facelift Replay Options Pages)

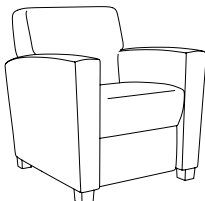
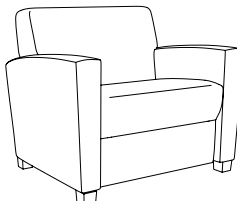
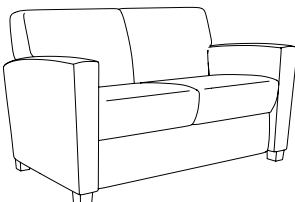
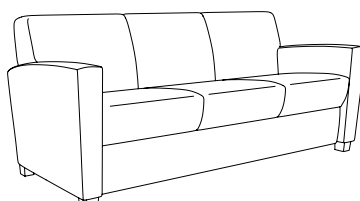
LOUNGE		ITEM #:	SPECIFICATIONS GRADES LIST PRICES:													
	LOUNGE CHAIR / FULLY UPHOLSTERED		Overall: 31.25"w 31"d 34.5"h Seat: 21"w 20"d 18"h			Arm: 25.5"h Weight: 80 lbs.			COM: 5.25 yds. COL: n/a							
			COM	COL	1	2	3	4	5	6	7	8	9	10	L1	L2
	1501		1542	N/A	1747	1891	2035	2180	2324	2468	2613	2757	2901	3046	N/A	N/A
		Tight Seat & Back / Removable Upholstery / 500 lb. Weight Capacity														
	1501-R	284	N/A	585	743	901	1059	1217	1375	1533	1691	1849	2007	N/A	N/A	
		Replacement Upholstery Covers														
	BARIATRIC LOUNGE CHAIR / FULLY UPHOLSTERED		Overall: 39.25"w 31"d 34.5"h Seat: 29"w 20"d 18"h			Arm: 25.5"h Weight: 95 lbs.			COM: 5.75 yds. COL: n/a							
			COM	COL	1	2	3	4	5	6	7	8	9	10	L1	L2
	1501-X		1908	N/A	2122	2281	2439	2598	2757	2916	3074	3233	3392	3551	N/A	N/A
		Tight Seat & Back / Removable Upholstery / 1000 lb. Weight Capacity														
	1501-XR	291	N/A	623	797	970	1144	1318	1492	1666	1840	2014	2187	N/A	N/A	
		Replacement Upholstery Covers														
	TWO PLACE SOFA / FULLY UPHOLSTERED		Overall: 56.75"w 31"d 34.5"h Seat: 46.5"w 20"d 18"h			Arm: 25.5"h Weight: 137 lbs.			COM: 7.25 yds. COL: n/a							
			COM	COL	1	2	3	4	5	6	7	8	9	10	L1	L2
	1502		2479	N/A	2748	2950	3152	3354	3556	3758	3960	4162	4364	4566	N/A	N/A
		Tight Seat & Back / Removable Upholstery / 1000 lb. Weight Capacity														
	1502-R	416	N/A	836	1057	1279	1500	1721	1942	2164	2385	2606	2828	N/A	N/A	
		Replacement Upholstery Covers														
	THREE PLACE SOFA / FULLY UPHOLSTERED		Overall: 80.25"w 31"d 34.5"h Seat: 70"w 20"d 18"h			Arm: 25.5"h Weight: 185 lbs.			COM: 9.25 yds. COL: n/a							
			COM	COL	1	2	3	4	5	6	7	8	9	10	L1	L2
	1503		3318	N/A	3657	3917	4176	4436	4696	4956	5216	5475	5735	5995	N/A	N/A
		Tight Seat & Back / Removable Upholstery / 1000 lb. Weight Capacity														
	1503-R	524	N/A	1064	1349	1634	1918	2203	2487	2772	3056	3341	3625	N/A	N/A	
		Replacement Upholstery Covers														

DESCRIPTION:

- Upholstery Frames: Steel, Plywood & Hardwood
- Seat: High Density Polyurethane Foam Over Strap Webbing
- Back: High Density Polyurethane Foam Over Sinuous Wire Springs
- Upholstered Covers: Attached w/ Velcro / Removable For Maintenance
- Antimicrobial Moisture Barrier Fully Encapsulates All Foam Areas
- Double Needle Stitching Standard (Welting Optional - No Charge)
- Exposed Wood Legs: Solid Hardwood / Removable For Maintenance
- Leather Upholstery Not Available
- Lifetime Warranty

OPTIONS:

- RWAC-1 Solid Wood Arm Caps (Set Of 2)\$374
- RPAC-1 Black Polyester Arm Caps (Set Of 2).....\$484
- ASL Aluminum Square Legs (Set Of 4).....\$382
- PM1 Power/Data Module (1-Power / 1-USB 2 Port Simplex Charger)\$859
- PM2 Power Module (1-Power).....\$238
- USB-1 Dual Charging USB\$238
- Feather Down & Polyester Pillows Available (See Page 5)
- Specify Exposed Wood Finish (See Page 6)
- Tablet Arm / Cup Holder Options (See Facelift Replay Options Pages)

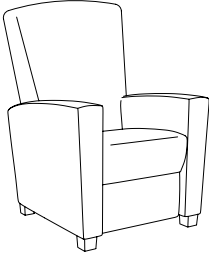
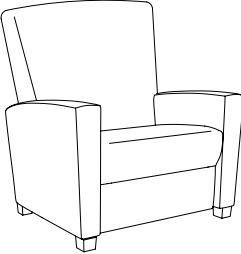
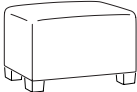
LOUNGE		ITEM #:	SPECIFICATIONS GRADES LIST PRICES:												
	HIGH BACK LOUNGE CHAIR / FULLY UPHOLSTERED		Overall: 31.25"w 31"d 44"h			Arm: 25.5"h			COM: 5.75 yds.						
	Seat: 21"w 20"d 18"h			Weight: 85 lbs.			COL: n/a								
		COM	COL	1	2	3	4	5	6	7	8	9	10	L1	L2
	1515	1652	N/A	1879	2038	2197	2355	2514	2673	2832	2990	3149	3308	N/A	N/A
<i>Tight Seat & Back / Removable Upholstery / 500 lb. Weight Capacity</i>															
	1515-R	301	N/A	633	807	980	1154	1328	1502	1676	1850	2024	2198	N/A	N/A
<i>Replacement Upholstery Covers</i>															
	HIGH BACK BARIATRIC LOUNGE CHAIR / FULLY UPHOLSTERED		Overall: 39.25"w 31"d 44"h			Arm: 25.5"h			COM: 6 yds.						
	Seat: 29"w 20"d 18"h			Weight: 100 lbs.			COL: n/a								
		COM	COL	1	2	3	4	5	6	7	8	9	10	L1	L2
	1515-X	2043	N/A	2249	2407	2566	2725	2884	3042	3201	3360	3519	3677	N/A	N/A
<i>Tight Seat & Back / Removable Upholstery / 1000 lb. Weight Capacity</i>															
	1515-XR	308	N/A	639	813	987	1161	1334	1508	1682	1856	2030	2204	N/A	N/A
<i>Replacement Upholstery Covers</i>															
	OTTOMAN		Overall: 22"w 18"d 15"h			Arm: n/a			COM: 2 yds.						
	Seat: 15"h			Weight: 18 lbs.			COL: n/a								
		COM	COL	1	2	3	4	5	6	7	8	9	10	L1	L2
	1516	530	N/A	602	653	703	754	804	855	905	956	1006	1057	N/A	N/A
<i>Tight Seat & Back / Removable Upholstery / 500 lb. Weight Capacity</i>															
	1516-R	121	N/A	225	280	336	391	446	502	557	612	668	723	N/A	N/A
<i>Replacement Upholstery Covers</i>															



DESCRIPTION:

- Exposed Wood Frames: Solid Maple (Steambent Wallsaver Back Legs)
- Glued, Screwed, & Doweled Construction
- Mortise & Tenon Construction (Stacking Chairs)
- Seat: High Density Polyurethane Foam Over Sheet Webbing
- Back: High Density Polyurethane Foam Over Plywood
- Upholstered Covers: Attached w/ Velcro / Removable For Maintenance (Except 1520/1521)
- Antimicrobial Moisture Barrier Fully Encapsulates All Foam Areas (Except 1520/1521)
- Adjustable Height Leveling Glides Standard
- Lifetime Warranty

OPTIONS:

- RPAC-3 Black Polyester Arm Caps (Set Of 2).....\$173
- ST-1 Wooden Horizontal Stretchers (Guest Chairs Only).....\$97
- BR-1 Wooden Horizontal Book Rack (Guest Chairs Only).....\$218
- MGP Metal Ganging Plates (Side Chairs).....\$97 Per Seat
- Stapled On Covers.....n/c

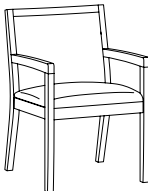
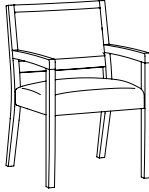
Specify Exposed Wood Finish (See Page 6)

GUEST	ITEM #:	SPECIFICATIONS GRADES LIST PRICES:													
		Overall: 22"w 24"d 33"h		Arm: 25"h					COM: 1.75 yds. (1520) / 1.5 yds. (1521)						
		Seat: 19.5"w 17.5"d 18.5"h		Weight: 28 lbs.					COL: n/a						
		COM	COL	1	2	3	4	5	6	7	8	9	10	L1	L2
	1520	1050	N/A	1080	1123	1166	1209	1253	1296	1339	1383	1426	1469	N/A	N/A
		<i>Wallsaver / Fully Upholstered Outside Back / Plain Seat / 350 lb. Weight Capacity</i>													
	1521	1078	N/A	1092	1128	1164	1200	1236	1272	1308	1344	1380	1416	N/A	N/A
		<i>Wallsaver / Exposed Wood Outside Back / Plain Seat / 350 lb. Weight Capacity</i>													
		Removable Covers / Antimicrobial Moisture Barrier Not Available On 1520/1521													
		Overall: 22"w 24"d 33"h		Arm: 25"h					COM: 2 yds. (1522) / 1.5 yds. (1523)						
		Seat: 19.5"w 19"d 18.5"h		Weight: 28 lbs.					COL: n/a						
		COM	COL	1	2	3	4	5	6	7	8	9	10	L1	L2
	1522	1014	N/A	1059	1110	1160	1211	1261	1312	1362	1413	1463	1514	N/A	N/A
		<i>Wallsaver / Upholstered Outside Back / Plain Seat / Removable Upholstery / 350 lb. Weight Capacity</i>													
	1522-R	94	N/A	188	238	287	337	386	436	485	534	584	633	N/A	N/A
		<i>Replacement Upholstery Covers</i>													
	1523	1030	N/A	1046	1082	1118	1154	1190	1226	1262	1299	1335	1371	N/A	N/A
		<i>Wallsaver / Exposed Wood Outside Back / Plain Seat / Removable Upholstery / 350 lb. Weight Capacity</i>													
	1523-R	91	N/A	168	209	251	292	333	374	415	457	498	539	N/A	N/A
		<i>Replacement Upholstery Covers</i>													
		Overall: 20"w 24"d 33"h		Arm: n/a					COM: 2 yds. (1524) / 1.5 yds. (1525)						
		Seat: 20"w 19"d 18.5"h		Weight: 25 lbs.					COL: n/a						
		COM	COL	1	2	3	4	5	6	7	8	9	10	L1	L2
	1524	946	N/A	996	1046	1097	1147	1198	1248	1299	1349	1400	1450	N/A	N/A
		<i>Wallsaver / Upholstered Outside Back / Plain Seat / Removable Upholstery / 350 lb. Weight Capacity</i>													
	1524-R	94	N/A	188	238	287	337	386	436	485	534	584	633	N/A	N/A
		<i>Replacement Upholstery Covers</i>													
	1525	957	N/A	977	1013	1049	1085	1121	1157	1193	1229	1265	1301	N/A	N/A
		<i>Wallsaver / Exposed Wood Outside Back / Plain Seat / Removable Upholstery / 350 lb. Weight Capacity</i>													
	1525-R	91	N/A	168	209	251	292	333	374	415	457	498	539	N/A	N/A
		<i>Replacement Upholstery Covers</i>													
		Overall: 20"w 24"d 39"h		Arm: n/a					COM: 2 yds.						
		Seat: 20"w 19"d 24"h		Weight: 28 lbs.					COL: n/a						
		COM	COL	1	2	3	4	5	6	7	8	9	10	L1	L2
	1524-C	977	N/A	1025	1075	1126	1176	1227	1277	1328	1378	1429	1479	N/A	N/A
		<i>Wallsaver / Upholstered Outside Back / Plain Seat / Removable Upholstery / 350 lb. Weight Capacity</i>													
	1524-R	94	N/A	188	238	287	337	386	436	485	534	584	633	N/A	N/A
		<i>Replacement Upholstery Covers</i>													

DESCRIPTION:



- Exposed Wood Frames: Solid Maple (Steambent Wallsaver Back Legs)
- Glued, Screwed, & Doweled Construction
- Mortise & Tenon Construction (Stacking Chairs)
- Seat: High Density Polyurethane Foam Over Sheet Webbing
- Back: High Density Polyurethane Foam Over Plywood
- Upholstered Covers: Attached w/ Velcro / Removable For Maintenance
- Antimicrobial Moisture Barrier Fully Encapsulates All Foam Areas
- Adjustable Height Leveling Glides Standard
- Lifetime Warranty

OPTIONS:



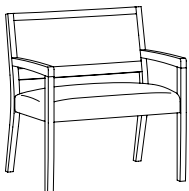
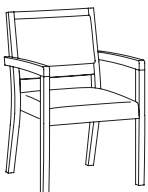

- RPAC-2 Black Polyester Arm Caps (Set Of 2).....\$173
- ST-1 Wooden Horizontal Stretchers (Guest Chairs Only).....\$97
- BR-1 Wooden Horizontal Book Rack (Guest Chairs Only).....\$218
- MGP Metal Ganging Plates (Side Chairs).....\$97 Per Seat
- SGS Soft Ganging Straps (Stacking Chairs).....\$34 Per Seat
- D800-6 Single Stacking Cart (Stacks 6 Chairs).....\$960 Each
- D800-12 Double Stacing Cart (Stacks 12 Chairs).....\$1268 Each
- Stapled On Covers n/c

Specify Exposed Wood Finish (See Page 6)

GUEST / STACKING		ITEM #:	SPECIFICATIONS GRADES LIST PRICES:												
	OPEN ARM BARIATRIC SIDE CHAIR / OPEN BACK		Overall: 28"w 24"d 33"h			Arm: 25"h			COM: 2.25 yds. (1528) / 1.75 yds. (1529)						
				Seat: 25.5"w 19"d 18.5"h			Weight: 28 lbs.			COL: n/a					
		COM	COL	1	2	3	4	5	6	7	8	9	10	L1	L2
	1528	1165	N/A	1217	1274	1332	1390	1448	1505	1563	1621	1678	1736	N/A	N/A
	<i>Wallsaver / Upholstered Outside Back / Plain Seat / Removable Upholstery / 500 lb. Weight Capacity</i>														
1528-R	104	N/A	198	247	297	346	396	445	495	544	594	643	N/A	N/A	
<i>Replacement Upholstery Covers</i>															
1529	1209	N/A	1229	1273	1316	1359	1403	1446	1489	1532	1576	1619	N/A	N/A	
<i>Wallsaver / Exposed Wood Outside Back / Plain Seat / Removable Upholstery / 500 lb. Weight Capacity</i>															
1529-R	101	N/A	178	219	260	301	343	384	425	466	508	549	N/A	N/A	
<i>Replacement Upholstery Covers</i>															
	OPEN ARM STACKING SIDE CHAIR / OPEN BACK		Overall: 22"w 24"d 33"h			Arm: 25"h			COM: 2 yds. (1532) / 1.5 yds. (1533)						
				Seat: 19.5"w 19"d 18.5"h			Weight: 28 lbs.			COL: n/a					
		COM	COL	1	2	3	4	5	6	7	8	9	10	L1	L2
	1532	1032	N/A	1077	1127	1178	1228	1279	1329	1380	1430	1481	1531	N/A	N/A
	<i>Wallsaver / Upholstered Outside Back / Plain Seat / Removable Upholstery / 350 lb. Weight Capacity</i>														
1532-R	94	N/A	188	238	287	337	386	436	485	534	584	633	N/A	N/A	
<i>Replacement Upholstery Covers</i>															
1533	1079	N/A	1092	1128	1164	1200	1236	1273	1309	1345	1381	1417	N/A	N/A	
<i>Wallsaver / Exposed Wood Outside Back / Plain Seat / Removable Upholstery / 350 lb. Weight Capacity</i>															
1533-R	91	N/A	168	209	251	292	333	374	415	457	498	539	N/A	N/A	
<i>Replacement Upholstery Covers</i>															

ARM CAPS / TABLETS	OPTION #: SPECIFICATIONS LIST PRICES AVAILABILITY:
<p>WOOD / POLYESTER ARM CAPS</p>  <p>RWAC-1 Solid Wood Arm Cap</p>  <p>RPAC-1 Polyester Arm Cap</p>	<p>Overall: 3.625"w 30.25"d .5"h</p> <hr/> <p>RWAC-1 \$374 (Set Of 2) <i>Solid Wood Arm Cap (Specify Finish)</i></p> <p>RPAC-1 \$484 (Set Of 2) <i>Black Polyester Arm Cap (Additional Colors Available)</i></p> <p>Available: Facelift Replay Lounge (1501-1515)</p> <p>RPAC-3 \$173 (Set Of 2) <i>Black Polyester Arm Cap (Additional Colors Available)</i></p> <p>Available: Facelift Replay Guest / Stacking</p>  <p>RPAC-3 Polyester Arm Cap</p>
<p>TABLET ARMS / CUP HOLDER</p>  <p>Laminate Tablet Arm Shown w/ Cup Holder</p>  <p>Veneer Tablet Arm Shown w/ Cup Holder</p>  <p>Solid Surface Tablet Arm Shown w/ Cup Holder</p>	<p>Overall: 14" Diameter .75"h</p> <hr/> <p>TA-L \$509 <i>Tablet Arm With 360° Rotation - High Pressure Laminate. (Specify Laminate / Specify Left Or Right Facing Arm Location)</i></p> <p>TA-V \$580 <i>Tablet Arm With 360° Rotation - Sunburst Cherry Veneer. (Specify Finish / Specify Left Or Right Facing Arm Location)</i></p> <p>TA-C \$698 <i>Tablet Arm With 360° Rotation - White Solid Surface. (Available In White Only / Specify Left Or Right Facing Arm Location)</i></p> <p>CH-1 \$129 <i>Black Plastic Cup Holder (Only Available If Used With Tablet Arm)</i></p> <p>CH-2 \$186 <i>Spun Aluminum Cup Holder (Only Available If Used With Tablet Arm)</i></p> <p>Available: Facelift Replay Lounge</p>
<p>FOLD DOWN TABLET ARM</p>  	<p>Overall: 14" Diameter .75"h</p> <hr/> <p>FDTA-L \$1065 <i>Tablet Arm With 360° Rotation - High Pressure Laminate. (Specify Laminate / Specify Left Or Right Facing Arm Location)</i></p> <p>FDTA-V \$1136 <i>Tablet Arm With 360° Rotation - Sunburst Cherry Veneer. (Specify Finish / Specify Left Or Right Facing Arm Location)</i></p> <p>FDTA-C \$1278 <i>Tablet Arm With 360° Rotation - White Solid Surface. (Available In White Only / Specify Left Or Right Facing Arm Location)</i></p> <p>Available: Facelift Replay Lounge</p>
<p>DOUBLE ARTICULATING / SWIVEL TABLET ARM</p>  <p>ATA-L Double Articulating / Swivel Tablet Arm</p>  <p>ATA-L w/ CH-1 Black Plastic Cup Holder</p>	<p>Overall: 14" Diameter .75"h</p> <hr/> <p>ATA-L \$983 <i>Tablet Arm With 360° Rotation - High Pressure Laminate. (Specify Laminate / Specify Left Or Right Facing Arm Location)</i></p> <p>ATA-V \$1055 <i>Tablet Arm With 360° Rotation - Sunburst Cherry Veneer. (Specify Finish / Specify Left Or Right Facing Arm Location)</i></p> <p>ATA-C \$1173 <i>Tablet Arm With 360° Rotation - White Solid Surface. (Available In White Only / Specify Left Or Right Facing Arm Location)</i></p> <p>CH-1 \$129 <i>Black Plastic Cup Holder (Only Available If Used With Tablet Arm)</i></p> <p>CH-2 \$186 <i>Spun Aluminum Cup Holder (Only Available If Used With Tablet Arm)</i></p> <p>Available: Facelift Replay Lounge</p>

LEGS / POWER / GANGING	OPTION #:	SPECIFICATIONS LIST PRICES AVAILABILITY:
<p>ALUMINUM LEGS</p> 	<p>ASL</p> <p><i>Overall: 2.25"w 2.25"d 2.25"h</i></p> <p>\$382 (Set Of 4) <i>(Brushed Finish)</i></p> <p><i>Available: Facelift Replay Lounge</i></p>	
<p>POWER / DATA MODULE</p>  <p>PM1 Power / Data Module</p>  <p>PM2 Power Module</p>  <p>USB-1 Dual Charging USB</p>	<p>PM1</p> <p><i>PM1 Overall: 5.25"w 1.25"d 4.25"h</i> <i>PM2 Overall: 2"w 2"d .125"h</i> <i>USB-1 Overall: 2"w 2"d .125"h</i></p> <p>\$859 Power/Data Module (1-Power / 1-USB 2 Port Simplex Charger Standard) <i>Vertical / Horizontal Mount Power Module. Price Varies By Socket. Contact Customer Service For Quote. (Additional Colors Available)</i></p> <p>PM2</p> <p>\$238 Power Module (1-Power) <i>Spill-Proof Technology / Multiple Finish Options / Storm Color Standard (Specify Left or Right Facing)</i></p> <p>USB-1</p> <p>\$238 Dual Charging USB (2 Port Simplex Charger Standard) <i>Spill-Proof Technology / 2 Amps Per Port / Multiple Finish Options / Storm Color Standard (Specify Left or Right Facing)</i></p> <p><i>Available: Facelift Replay Lounge</i></p>	
<p>METAL GANGING PLATES</p>  <p>Replay Side Chairs Ganged With Metal Ganging Plates</p>   <p>Female & Male Ganging Connectors</p>	<p>MGP</p> <p><i>Overall: 1.5"w .5"d</i></p> <p>\$97 Per Seat <i>(Black Finish)</i></p> <p><i>Available: Facelift Replay Side Chairs</i></p>	
<p>SOFT GANGING STRAPS</p>  <p>Replay Stacking Chairs Soft Ganged</p>	<p>SGS</p> <p><i>Overall: 4"w 2"d</i></p> <p>\$34 Per Seat <i>Black Velcro Soft Ganging Straps</i></p> <p><i>Available: Facelift Replay Stacking Chairs</i></p>	

STRETCHERS / BOOK RACK / STACKING / COVERS	OPTION #:	SPECIFICATIONS LIST PRICES AVAILABILITY:
<p>STRETCHERS / CARTS / COVERS</p> 	<p>ST-1</p> <p><i>Overall: 23"w 25"d 1"h</i></p> <p>\$97 <i>Wooden Horizontal Stretchers</i></p> <p><i>Available: Facelift Replay Guest Chairs</i></p>	
<p>BOOK RACK</p> 	<p>BR-1</p> <p><i>Overall: 23"w 25"d 1"h</i></p> <p>\$218 <i>Wooden Horizontal Book Rack</i></p> <p><i>Available: Facelift Replay Guest Chairs</i></p>	
<p>STACKING CARTS</p>  <p>Single Stacking</p> <p>Double Stacking</p>	<p><i>Overall: 26"w 37"d 12"h (Single Stacking Cart) / 37"w 50"d 12"h (Double Stacking Cart)</i></p> <p>D800-6 \$960 <i>Single Stacking Cart (Stacks 6 Chairs)</i></p> <p>D800-12 \$1268 <i>Double Stacking Cart (Stacks 12 Chairs)</i></p> <p><i>Available: Replay Stacking Chairs</i></p>	
<p>CONTRASTING COVERS</p> 	<p><i>Overall: N/A</i></p> <p>CC \$129</p> <p><i>NOTE: If Two Or More Upholsteries Or Leathers Are Used On Any Piece Of Furniture, Then A Contrast Charge Will Apply Per Order. When Using Trinity Upholstery, The Higher Priced Upholstery Grade Will Be Used In Pricing, Unless It's Trinity Leather With Fabric Contrast Welt, Or COM With Trinity Contrast Welt, Then Contact Customer Service For Pricing.</i></p> <p><i>Available: Facelift Replay Collection</i></p>	

Facelift Replay

HEALTHCARE MOTION

Effective: March 1, 2025

T R I N I T Y

Date:

Page:

Modification:

Description:

DESCRIPTION:

- Upholstery Frames: Steel, Plywood & Hardwood
- Seat: High Density Polyurethane Foam Over Sheet Webbing
- Back: High Density Polyurethane Foam Over Polypropylene Webbing
- Upholstered Covers: Attached w/ Velcro / Removable For Maintenance
- Removable Bolster Pillow For 1504 / 1505 (5" Diameter)
- Antimicrobial Moisture Barrier Fully Encapsulates All Foam Areas
- Double Needle Stitching Standard (Welting Optional - No Charge)
- Metal To Metal Connections For All Hardware Assembly
- Leather Upholstery Not Available
- Lifetime Warranty

OPTIONS:

- RWAC-3 Solid Wood Arm Caps (Set Of 2)\$411
- RPAC-2 Polyester Arm Caps (Set Of 2)\$518
- LC Locking Casters (Set Of 2)\$44
- NLC Non-Locking Casters (Set Of 2).....\$37
- 3LC 3" Locking Casters - #1506 Model Only (Set Of 2).....\$218
- PM1 Power/Data Module (1-Power / 1-USB 2 Port Simplex Charger)\$859
- Tablet Arm / Cup Holder Options (See Facelift Replay Healthcare Options Pages)
- Feather Down & Polyester Pillows Available (See Page 5)
- Specify Exposed Wood Finish (See Page 6)

SLEEPOVER UNITS

ITEM #: SPECIFICATIONS | GRADES | LIST PRICES:

LOUNGE CHAIR / FULLY UPHOLSTERED

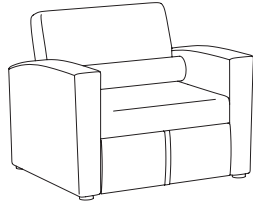

Healthcare Motion

		Overall: 37.5"w 34.5"d 33"h				Overall Length: 84"d				Arm: 24"h		COM: 6.5 yds.	
		Sleep Area: 28"w 80"d				Seat: 28"w 23"d 17.5"h				Weight: 175 lbs.		COL: n/a	
COM	COL	1	2	3	4	5	6	7	8	9	10	L1	L2
1504	N/A	4860	5040	5221	5401	5582	5762	5942	6123	6303	6484	N/A	N/A
<i>Tight Seat & Back / Removable Upholstery / 500 lb. Weight Capacity</i>													
1504-R	N/A	719	916	1114	1311	1509	1706	1904	2102	2299	2497	N/A	N/A
<i>Replacement Upholstery Covers</i>													

TWO PLACE SOFA / FULLY UPHOLSTERED

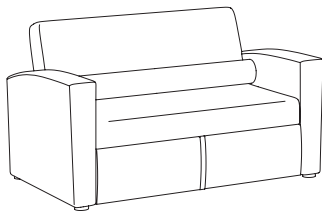

Healthcare Motion

		Overall: 57.5"w 34.5"d 33"h				Overall Length: 84"d				Arm: 24"h		COM: 9 yds.	
		Sleep Area: 48"w 80"d				Seat: 48"w 23"d 17.5"h				Weight: 225 lbs.		COL: n/a	
COM	COL	1	2	3	4	5	6	7	8	9	10	L1	L2
1505	N/A	6067	6320	6572	6825	7077	7330	7583	7835	8088	8340	N/A	N/A
<i>Tight Seat & Back / Removable Upholstery / 750 lb. Weight Capacity</i>													
1505-R	N/A	949	1225	1502	1779	2055	2332	1660	1818	1976	2134	N/A	N/A
<i>Replacement Upholstery Covers</i>													

FOUR POSITION ADJUSTMENT FOR 1504 / 1505

See Revival Healthcare Motion And Evolve Healthcare Motion For Additional Sleeper Units.



1) Closed Position



2) Ottoman Position



3) Chaise Position



4) Full-Recline Position
Overall Length - 84"d

BACK-FLIP SLEEPER SOFA

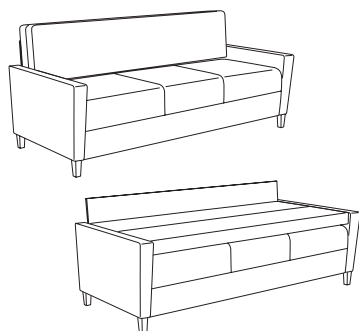





		Overall: 79"w 36"d 36"h				Arm: 24.5"h				COM: 13 yds.			
		Sleep Area: 70"w 31"d 20"h				Weight: 235 lbs.				COL: n/a			
COM	COL	1	2	3	4	5	6	7	8	9	10	L1	L2
1506	N/A	4723	5091	5459	5827	6195	6564	6932	7300	7668	8036	N/A	N/A
<i>Tight Seat & Back / Removable Upholstery / 1000 lbs. Weight Capacity</i>													
1506-R	N/A	1914	2309	2704	3099	3494	3889	4285	4680	5075	5470	N/A	N/A
<i>Replacement Upholstery Covers</i>													

DESCRIPTION:

- Upholstery Frames: Steel, Plywood & Hardwood
- Seat: High Density Polyurethane Foam Over Sheet Webbing
- Back: High Density Polyurethane Foam Over Sinuous Wire Springs
- Upholstered Covers: Attached w/ Velcro / Removable For Maintenance
- Antimicrobial Moisture Barrier Fully Encapsulates All Foam Areas
- Central Braking w/ Lock & unlocks pedals
- Double Needle Stitching Standard (Welting Optional - No Charge)
- Dual-Wheel Casters: (2) Front Locking/Swivel & (2) Rear Non-Locking/Non-Swivel
- Leather Upholstery Not Available
- Lifetime Warranty

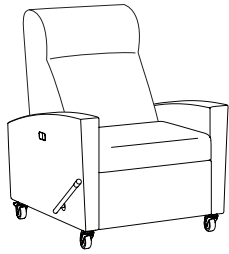
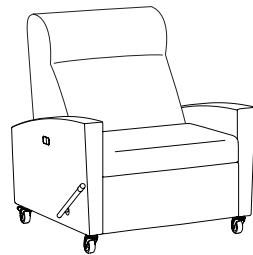
OPTIONS:

Layflat Medical Recliner Options (See Facelift Replay Healthcare Options Pages)
 Feather Down & Polyester Pillows Available (See Page 5)

INFUSION RECLINERS		ITEM #:	SPECIFICATIONS GRADES LIST PRICES:														
		INFUSION LAYFLAT MEDICAL RECLINER	Overall: 32.75"w 38.5"d 45"h Seat: 24"w 20"d 20"h			Arm: 28"h Weight: 160 lbs.			COM: 5.5 yds. COL: n/a								
			COM	COL	1	2	3	4	5	6	7	8	9	10	L1	L2	
			1507-L	3776	N/A	3853	3995	4136	4277	4419	4560	4702	4843	4984	5126	N/A	N/A
			<i>Infusion Layflat / Tight Seat & Back / Removable Upholstery / 500 lb. Weight Capacity</i>														
		BARIATRIC INFUSION LAYFLAT MEDICAL RECLINER	Overall: 37.75"w 38.5"d 45"h Seat: 29"w 20"d 20"h			Arm: 28"h Weight: 185 lbs.			COM: 6 yds. COL: n/a								
			COM	COL	1	2	3	4	5	6	7	8	9	10	L1	L2	
			1507-XL	3866	N/A	3962	4115	4268	4421	4574	4728	4881	5034	5187	5340	N/A	N/A
			<i>Infusion Layflat / Tight Seat & Back / Removable Upholstery / 600 lb. Weight Capacity</i>														
			1507-T	3856	N/A	3929	4070	4211	4353	4494	4636	4777	4918	5060	5201	N/A	N/A
			<i>Infusion Trendelenburg / Tight Seat & Back / Removable Upholstery / 500 lb. Weight Capacity</i>														
			1507-R	376	N/A	721	903	1086	1268	1451	1633	1816	1999	2181	2364	N/A	N/A
			<i>Replacement Upholstery Covers</i>														
			1507-XR	383	N/A	762	962	1162	1362	1562	1762	1962	2162	2362	2562	N/A	N/A
			<i>Replacement Upholstery Covers</i>														

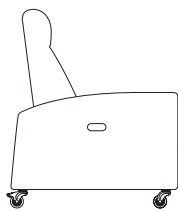

Upright Position
38.5"D

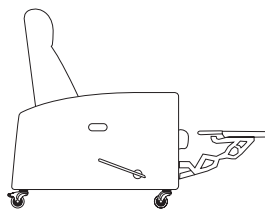

Extended Footrest Position
57.5"D

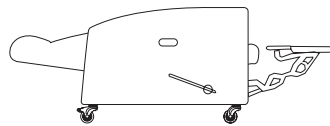

Layflat Position
73.75"D7

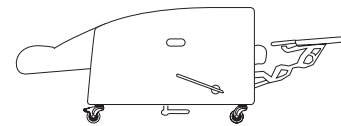

Trendelenburg Position
4.75"D

 See Revival Healthcare Motion And Evolve Healthcare Motion For Additional Infusion Layflat Medical Recliners.

DESCRIPTION:

- Upholstery Frames: Steel, Plywood & Hardwood
- Seat: High Density Polyurethane Foam Over Sheet Webbing
- Back: High Density Polyurethane Foam Over Polypropylene Webbing
- Upholstered Covers: Attached w/ Velcro / Removable For Maintenance
- Antimicrobial Moisture Barrier Fully Encapsulates All Foam Areas
- Double Needle Stitching Standard (Wetling Optional - No Charge)
- Exposed Wood Legs: Solid Hardwood / Removable For Maintenance
- Leather Upholstery Not Available
- Lifetime Warranty

OPTIONS:

- RWAC-1 Solid Wood Arm Caps (Set Of 2)\$374
 - RPAC-1 Polyester Arm Caps (Set Of 2)\$484
 - ASL Aluminum Square Legs (Set Of 4).....\$382
 - LC Locking Casters For 1809 Ottoman (Set Of 2)\$44
 - WR Wood Ring Base - Replaces Metal Base On 1510-G/1510-SG\$224
 - PM1 Power/Data Module (1-Power / 1-USB 2 Port Simplex Charger)\$859
- Feather Down & Polyester Pillows Available (See Page 5)
Specify Exposed Wood Finish (See Page 6)
Tablet Arm / Cup Holder Options (See Facelift Replay Healthcare Options Pages)

PATIENT CHAIR / GLIDER

ITEM #: SPECIFICATIONS | GRADES | LIST PRICES:

ASYNCHRONOUS PATIENT CHAIR / FULLY UPHOLSTERED

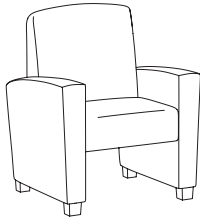

Healthcare Motion

		Overall: 32.5"w 35.5"d 38"h (1508) / 37.5"w 35.5"d 38"h (1508-X)										Arm: 24"h		COM: 4.5 yds.	
		Seat: 21"w 20"d 18"h (1508) / 26"w 20"d 18"h (1508-X)										Weight: 70 lbs.		COL: n/a	
COM	COL	1	2	3	4	5	6	7	8	9	10	L1	L2		
1508	N/A	1865	2016	2166	2316	2467	2617	2767	2918	3068	3218	N/A	N/A		
<i>Tight Seat & Back / Removable Upholstery / 500 lb. Weight Capacity</i>															
1508-R	N/A	509	643	778	912	1046	1181	1315	1449	1584	1718	N/A	N/A		
<i>Replacement Upholstery Covers</i>															
1508-X	N/A	1965	2132	2299	2467	2634	2801	2968	3135	3302	3469	N/A	N/A		
<i>Tight Seat & Back / Removable Upholstery / 500 lbs. Weight Capacity</i>															
1508-XR	N/A	509	643	778	912	1046	1181	1315	1449	1584	N/A	N/A			
<i>Replacement Upholstery Covers</i>															

OTTOMAN ON CASTERS / STOWS UNDER ALL PATIENT CHAIRS

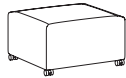

Healthcare Motion

		Overall: 18"w 18"d 11"h					Arm: n/a					COM: 1 yd.			
		Seat: n/a					Weight: 25 lbs.					COL: n/a			
COM	COL	1	2	3	4	5	6	7	8	9	10	L1	L2		
1809		386	425	409	430	452	474	495	517	539	560	582	603	N/A	N/A
<i>Removable Upholstery / 350 lb. Weight Capacity</i>															
1809-R		94	103	136	160	183	207	231	254	278	302	326	349	N/A	N/A
<i>Replacement Upholstery Covers</i>															

LOUNGE GLIDER / FULLY UPHOLSTERED

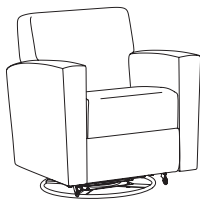

Healthcare Motion

		Overall: 32"w 32"d 35"h					Arm: 24"h					COM: 5.25 yds.	
		Seat: 21"w 20"d 18"h					Weight: 115 lbs.					COL: n/a	
COM	COL	1	2	3	4	5	6	7	8	9	10	L1	L2
1510-G	N/A	2013	2157	2301	2446	2590	2734	2878	3023	3167	3311	N/A	N/A
<i>Circular Metal Base / Tight Seat & Back / Removable Upholstery / 500 lb. Weight Capacity</i>													
1510-SG	N/A	2151	2295	2440	2584	2728	2873	3017	3161	3306	3450	N/A	N/A
<i>Swivel Glider w/ Circular Metal Base / Tight Seat & Back / Removable Upholstery / 500 lb. Weight Capacity</i>													
1510-R	N/A	581	739	897	1055	1213	1371	1529	1687	1846	2004	N/A	N/A
<i>Replacement Upholstery Covers</i>													

See Revival Healthcare Motion And Evolve Healthcare Motion For Additional Patient Chairs & Gliders.

DESCRIPTION:

- Upholstery Frames: Steel, Plywood & Hardwood
- Seat: High Density Polyurethane Foam Over Sheet Webbing
- Back: High Density Polyurethane Foam Over Sinuous Wire Springs
- Upholstered Covers: Attached w/ Velcro / Removable For Maintenance
- Antimicrobial Moisture Barrier Fully Encapsulates All Foam Areas
- Double Needle Stitching Standard (Welting Optional - No Charge)
- Leather Upholstery Not Available
- Lifetime Warranty







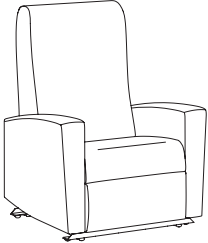

OPTIONS:

(See Facelift Replay Healthcare Options Pages)

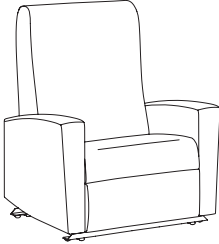
- RWAC-1 Solid Wood Arm Caps (Set Of 2)\$374
- RPAC-1 Polyester Arm Caps (Set Of 2)\$484
- ER-1 Electric Recline\$1054
- BB Battery Backup\$548
- HM Heat & Massage\$1498
- H Heat Only\$1142

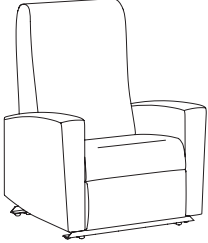
Feather Down & Polyester Pillows Available (See Page 5)

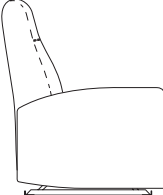
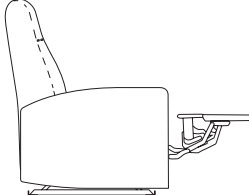
Specify Exposed Wood Finish (See Page 6)

WALLSAVER		ITEM #:	SPECIFICATIONS GRADES LIST PRICES:															
	WALLSAVER RECLINER / FULLY UPHOLSTERED		<i>Overall: 30.5"w 32"d 43"h</i>			<i>Arm: 23"h</i>			<i>COM: 5 yds.</i>									
	<i>Seat: 21"w 20.5"d 18"h</i>			<i>Weight: 110 lbs.</i>			<i>COL: n/a</i>											
				COM	COL	1	2	3	4	5	6	7	8	9	10	L1	L2	
	1511		2089	N/A	2292	2451	2610	2768	2927	3086	3245	3403	3562	3721	N/A	N/A		
			<i>Tight Seat & Back / Removable Upholstery / 6" Wall Proximity / 350 lb. Weight Capacity</i>															
	1511-R		296	N/A	580	730	880	1030	1181	1331	1481	1631	1781	1931	N/A	N/A		
			<i>Replacement Upholstery Covers</i>															
			 Healthcare Motion															
	BARIATRIC WALLSAVER RECLINER / FULLY UPHOLSTERED		<i>Overall: 35.5"w 32"d 43"h</i>			<i>Arm: 23"h</i>			<i>COM: 5.5 yds.</i>									
	<i>Seat: 26"w 20.5"d 18"h</i>			<i>Weight: 125 lbs.</i>			<i>COL: n/a</i>											
				COM	COL	1	2	3	4	5	6	7	8	9	10	L1	L2	
	1511-X		2230	N/A	2426	2585	2743	2902	3061	3219	3378	3537	3696	3854	N/A	N/A		
			<i>Tight Seat & Back / Removable Upholstery / 6" Wall Proximity / 500 lb. Weight Capacity</i>															
	1511-XR		302	N/A	618	784	950	1116	1282	1448	1614	1780	1946	2112	N/A	N/A		
			<i>Replacement Upholstery Covers</i>															
			 Healthcare Motion															
	ELECTRIC WALLSAVER RECLINER / FULLY UPHOLSTERED		<i>Overall: 30.5"w 32"d 43"h</i>			<i>Arm: 23"h</i>			<i>COM: 5 yds.</i>									
	<i>Seat: 21"w 20.5"d 18"h</i>			<i>Weight: 110 lbs.</i>			<i>COL: n/a</i>											
				COM	COL	1	2	3	4	5	6	7	8	9	10	L1	L2	
	1511-E		3036	N/A	3188	3346	3505	3664	3822	3981	4140	4299	4457	4616	N/A	N/A		
			<i>Tight Seat & Back / Removable Upholstery / 6" Wall Proximity / 350 lb. Weight Capacity</i>															
	1511-R		296	N/A	580	730	880	1030	1181	1331	1481	1631	1781	1931	N/A	N/A		
			<i>Replacement Upholstery Covers</i>															
			 Healthcare Motion															
			 See Revival Healthcare Motion And Evolve Healthcare Motion For Additional Wallsaver Recliners.															
																		
						Upright Position 32°D			Extended Footrest Position 52°D			Full Recline Position 64.5°D						

DESCRIPTION:

- Upholstery Frames: Steel, Plywood & Hardwood
- Seat: High Density Polyurethane Foam Over Sheet Webbing
- Back: High Density Polyurethane Foam Over Sinuous Wire Springs
- Upholstered Covers: Attached w/ Velcro / Removable For Maintenance
- Antimicrobial Moisture Barrier Fully Encapsulates All Foam Areas
- Double Needle Stitching Standard (Wetling Optional - No Charge)
- Dual-Wheel Casters: (2) Front Locking/Swivel & (2) Rear Non-Locking/Non-Swivel (1514)
- (2) Drop Down Side Trays Mounted To Black Metal Tubing (1514)
- Exposed Wood Legs (1512): Solid Hardwood / Removable For Maintenance
- Leather Upholstery Not Available
- Lifetime Warranty

OPTIONS:

(See Facelift Replay Healthcare Options Pages)
 Feather Down & Polyester Pillows Available (See Page 5)

INFUSION / STAND-UP RECLINER

ITEM #:

SPECIFICATIONS | GRADES | LIST PRICES:

INFUSION WALLSAVER RECLINER / FULLY UPHOLSTERED



Optional Central Braking Available

Healthcare Motion

See Revival & Evolve Healthcare Motion For Additional Infusion Wall Saver Recliners.

Overall: 31.25"w 34"d 46"h **Arm:** 27"h **COM:** 5 yds.
Seat: 21"w 20.5"d 19"h **Weight:** 130 lbs. **COL:** n/a

COM	COL	1	2	3	4	5	6	7	8	9	10	L1	L2
1514	N/A	3373	3532	3691	3851	4010	4169	4328	4487	4646	4805	N/A	N/A
<i>Tight Seat & Back / Removable Upholstery / 350 lb. Weight Capacity</i>													
1514-R	N/A	669	851	1033	1214	1396	1578	1760	1942	2123	2305	N/A	N/A
<i>Replacement Upholstery Covers</i>													

***NOTE: ELECTRIC OPTION NOT AVAILABLE ON INFUSION RECLINERS IN COMBINATION WITH CASTERS.**



Upright Position
32"D



Extended Footrest Position
52"D



Full Recline Position
64.5"D

ELECTRIC STAND-UP RECLINER / FULLY UPHOLSTERED

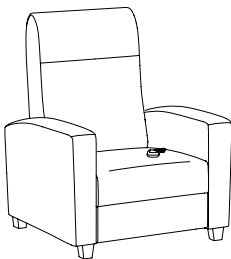

Healthcare Motion

See Revival Healthcare Motion For Additional Electric Stand-Up Recliner.

Overall: 33"w 35"d 42"h **Arm:** 24.5"h **COM:** 6.5 yds.
Seat: 21.5"w 21.75"d 18"h **Weight:** 145 lbs. **COL:** n/a

COM	COL	1	2	3	4	5	6	7	8	9	10	L1	L2
1512	N/A	3658	3866	4075	4284	4493	4701	4910	5119	5328	5537	N/A	N/A
<i>Tight Seat & Back / Removable Upholstery / 350 lb. Weight Capacity</i>													
1512-R	N/A	704	902	1100	1297	1495	1692	1890	2088	2285	2483	N/A	N/A
<i>Replacement Upholstery Covers</i>													

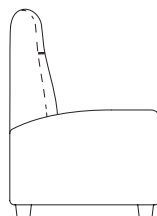

Upright Position
35"D

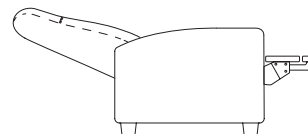

Full Recline Position
66"D

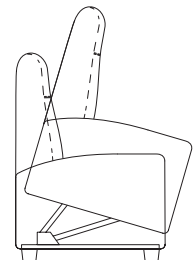

Stand-Up Position
59"H

DESCRIPTION:

- Upholstery Frames: Steel, Plywood & Hardwood
- Seat: High Density Polyurethane Foam Over Sheet Webbing
- Back: High Density Polyurethane Foam Over Sinuous Wire Springs
- Upholstered Covers: Attached w/ Velcro / Removable For Maintenance
- Antimicrobial Moisture Barrier Fully Encapsulates All Foam Areas
- Double Needle Stitching Standard (Welting Optional - No Charge)
- Rotational & Directional Locking Casters (Rear)
- Leather Upholstery Not Available
- Lifetime Warranty

OPTIONS:

Layflat Medical Recliner Options (See Facelift Replay Healthcare Options Pages)
 Feather Down & Polyester Pillows Available (See Page 5)

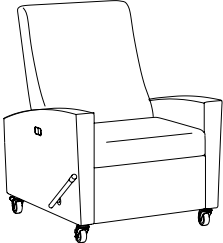
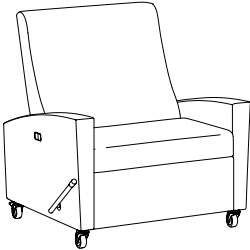
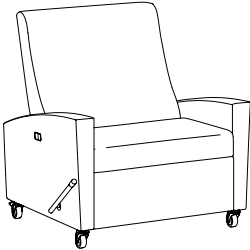
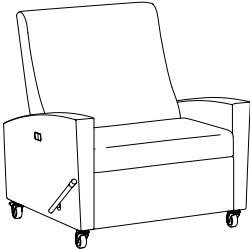
LAYFLAT MEDICAL RECLINER		ITEM #:	SPECIFICATIONS GRADES LIST PRICES:														
		LAYFLAT / TRENDELENBURG RECLINER	Overall: 32.75"w 38.5"d 45"h Seat: 24"w 20"d 20"h			Arm: 28"h Weight: 160 lbs.			COM: 5.5 yds. COL: n/a								
			COM	COL	1	2	3	4	5	6	7	8	9	10	L1	L2	
			1513-L	3728	N/A	3875	4050	4226	4401	4577	4752	4927	5103	5278	5454	N/A	N/A
			<i>Layflat / Tight Seat & Back / Removable Upholstery / 500 lb. Weight Capacity</i>														
		BARIATRIC LAYFLAT / TRENDELENBURG RECLINER	Overall: 37.75"w 38.5"d 45"h Seat: 29"w 20"d 20"h			Arm: 28"h Weight: 185 lbs.			COM: 6 yds. COL: n/a								
			COM	COL	1	2	3	4	5	6	7	8	9	10	L1	L2	
			1513-XL	3855	N/A	4029	4221	4413	4605	4797	4989	5181	5373	5566	5758	N/A	N/A
			<i>Layflat / Tight Seat & Back / Removable Upholstery / 600 lb. Weight Capacity</i>														
		BARIATRIC LAYFLAT / TRENDELENBURG RECLINER	Overall: 37.75"w 38.5"d 45"h Seat: 29"w 20"d 20"h			Arm: 28"h Weight: 185 lbs.			COM: 6 yds. COL: n/a								
			COM	COL	1	2	3	4	5	6	7	8	9	10	L1	L2	
			1513-XT	4032	N/A	4196	4388	4580	4772	4964	5156	5348	5540	5733	5925	N/A	N/A
			<i>Trendelenburg / Tight Seat & Back / Removable Upholstery / 600 lb. Weight Capacity</i>														
		BARIATRIC LAYFLAT / TRENDELENBURG RECLINER	Overall: 37.75"w 38.5"d 45"h Seat: 29"w 20"d 20"h			Arm: 28"h Weight: 185 lbs.			COM: 6 yds. COL: n/a								
			COM	COL	1	2	3	4	5	6	7	8	9	10	L1	L2	
			1513-XR	349	N/A	693	875	1057	1238	1420	1602	1784	1966	2147	2329	N/A	N/A
			<i>Replacement Upholstery Covers</i>														

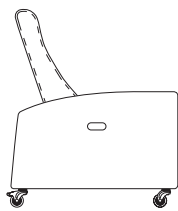

Upright Position
38.5"D

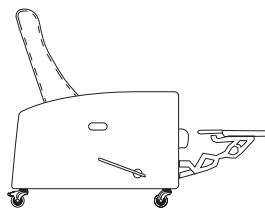

Extended Footrest Position
57.5"D

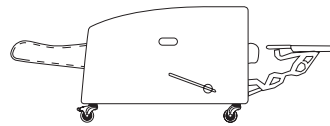

Layflat Position
73.75"D

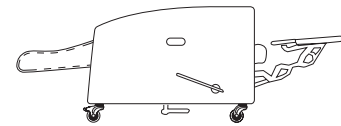





Trendelenburg Position
74.75"D

See Revival Healthcare Motion And Evolve Healthcare Motion For Additional Layflat Medical Recliners.

ARM CAPS / TABLETS	OPTION #: SPECIFICATIONS LIST PRICES AVAILABILITY:
<p>SOLID WOOD ARM CAPS</p> 	<p>Overall: Dimensions Will Vary By Style</p> <hr/> <p>RWAC-1 \$374 (Set Of 2) (1508 Asynchronous Patient Chair) - Specify Finish (1510-G Lounge Glider / 1510-SG Lounge Swivel Glider) - Specify Finish (1511 Wallsaver Recliner / 1511-X Bariatric Wallsaver Recliner / 1514 Infusion Wallsaver Recliner) - Specify Finish</p> <p>RWAC-2 \$411 (Set Of 2) (1512 Electric Standup Recliner) - Specify Finish</p> <p>RWAC-3 \$411 (Set Of 2) (1504 / 1505 Sleepover Lounge) - Specify Finish (1513-L & 1513-T Medical Recliners / 1513-XL & 1513-XT Bariatric Medical Recliners) - Specify Finish</p>
<p>POLYESTER ARM CAPS</p> 	<p>Overall: Dimensions Will Vary By Style</p> <hr/> <p>RPAC-1 \$484 (Set Of 2) POLYESTER (1508 Asynchronous Patient Chair) (1510-G Lounge Glider / 1510-SG Lounge Swivel Glider) (1511 Wallsaver Recliner / 1511-X Bariatric Wallsaver Recliner / 1514 Infusion Wallsaver Recliner)</p> <p>RPAC-2 \$518 (Set Of 2) POLYESTER (1504 / 1505 Sleepover Lounge) - Specify Finish (1507-L, 1507-T, 1507-XL, 1507-XT, 1513-L, 1513-T, 1513-XL, 1513-XT Medical Recliners) - Specify Finish</p>
<p>TABLET ARMS / CUP HOLDER</p>  <p>Laminate Tablet Arm Shown w/ Cup Holder</p>  <p>Veneer Tablet Arm Shown w/ Cup Holder</p>  <p>Solid Surface Tablet Arm Shown w/ Cup Holder</p>	<p>Overall: 14" Diameter .75"h</p> <hr/> <p>TA-L \$509 Tablet Arm With 360° Rotation - High Pressure Laminate. (Specify Laminate / Specify Left Or Right Facing Arm Location)</p> <p>TA-V \$580 Tablet Arm With 360° Rotation - Sunburst Cherry Veneer. (Specify Finish / Specify Left Or Right Facing Arm Location)</p> <p>TA-C \$698 Tablet Arm With 360° Rotation - White Solid Surface. (Available In White Only / Specify Left Or Right Facing Arm Location)</p> <p>CH-1 \$129 Black Plastic Cup Holder (Only Available If Used With Tablet Arm)</p> <p>CH-2 \$186 Spun Aluminum Cup Holder (Only Available If Used With Tablet Arm)</p> <p>Available: Facelift Replay Sleepover Lounge</p>
<p>FOLD DOWN TABLET ARM</p>  	<p>Overall: 14" Diameter .75"h</p> <hr/> <p>FDTA-L \$1065 Tablet Arm With 360° Rotation - High Pressure Laminate. (Specify Laminate / Specify Left Or Right Facing Arm Location)</p> <p>FDTA-V \$1136 Tablet Arm With 360° Rotation - Sunburst Cherry Veneer. (Specify Finish / Specify Left Or Right Facing Arm Location)</p> <p>FDTA-C \$1278 Tablet Arm With 360° Rotation - White Solid Surface. (Available In White Only / Specify Left Or Right Facing Arm Location)</p> <p>Available: Facelift Replay Sleepover Lounge</p>

TABLETS / CASTERS	OPTION #:	SPECIFICATIONS LIST PRICES AVAILABILITY:
DOUBLE ARTICULATING / SWIVEL TABLET ARM		
<i>Overall: 14" Diameter .75"h</i>		
	ATA-L	\$983 <i>Tablet Arm With 360° Rotation - High Pressure Laminate. (Specify Laminate / Specify Left Or Right Facing Arm Location)</i>
ATA-L Double Articulating / Swivel Tablet Arm	ATA-V	\$1055 <i>Tablet Arm With 360° Rotation - Sunburst Cherry Veneer. (Specify Finish / Specify Left Or Right Facing Arm Location)</i>
	ATA-C	\$1173 <i>Tablet Arm With 360° Rotation - White Solid Surface. (Available In White Only / Specify Left Or Right Facing Arm Location)</i>
ATA-L w/ CH-1 Black Plastic Cup Holder	CH-1	\$129 <i>Black Plastic Cup Holder (Only Available If Used With Tablet Arm)</i>
	CH-2	\$186 <i>Spun Aluminum Cup Holder (Only Available If Used With Tablet Arm)</i>
<i>Available: Facelift Replay Sleepover Lounge</i>		
SIDE MOUNT / FOLD DOWN TABLET W/ LOCK & SWIVEL		
<i>Overall: 14" Diameter .75"h</i>		
	SMFDT-L	\$722 <i>Up & Away w/ Lock & High Pressure Laminate Top. (Specify Laminate / Specify Left Or Right Facing Arm Location)</i>
	SMFDT-V	\$1007 <i>Up & Away w/ Lock & Veneer Top. (Specify Finish / Specify Left Or Right Facing Arm Location)</i>
	SMFDT-C	\$1126 <i>Up & Away w/ Lock & White Solid Surface Top. (Available In White Only / Specify Left Or Right Facing Arm Location)</i>
<i>Available: Facelift Replay 1507, 1512, 1513, 1857, 1812, 1813</i>		
LOCKING / NON-LOCKING CASTERS		
<i>Overall: 1.875"w 2.25"d 1.5"h (Locking) / 1.875"w 1.625"d 1.5"h (Non-Locking)</i>		
	LC	\$44 (Set Of Two) <i>Locking Casters (Black Finish / Specify Location)</i>
	NLC	\$37 (Set Of Two) <i>Non-Locking Casters (Black Finish / Specify Location)</i>
Locking Casters		<i>Available: Facelift Replay Sleepover Lounge</i>
Non-Locking Casters		
WALLSAVER - LOCKING / NON-LOCKING CASTERS		
<i>Overall: 2.5"w 4"d 3.5"h (Locking) / 2.5"w 3.25"d 3.5"h (Non-Locking)</i>		
	WLC	\$199 List (Set Of Two) <i>Locking Swivel Casters (Gray Finish / Back Location)</i>
	WNLC	\$185 List (Set Of Two) <i>Non-Locking / Non-Swivel Casters (Gray Finish / Front Location)</i>
Locking Casters		<i>Note: Wallsaver Locking / Non-Locking Casters Cannot Be Used In Combination With Electric Recline.</i>
Non-Locking Casters		<i>Available: Facelift Wallsaver Recliners (1511 / 1811 / 1855 & Bariatric Versions)</i>
MEDICAL LOCKING / NON-LOCKING CASTERS		
<i>Overall: 2.25"w 5"d 5.25"h (Locking) / 2"w 3.75"d 5.25"h (Non-Locking)</i>		
	MLC	\$194 (Set Of Two) <i>Locking Casters - Motion & Direction (Gray Finish / Specify Location)</i>
	MNLC	\$224 (Set Of Two) <i>Non-Locking Casters - Single Direction (Gray Finish / Specify Location)</i>
Locking Casters		<i>Available: Facelift Replay Electric Standup Recliner</i>
Non-Locking Casters		

BRAKE / LEGS / POWER / ELECTRIC / PUSH BAR	OPTION #:	SPECIFICATIONS LIST PRICES AVAILABILITY:
<p>CENTRAL BRAKING</p> 	<p>Overall: 7.5"w 2"d .5"h</p> <hr/> <p>CB-1 \$508 (Set Of 1) <i>(Gray Plastic Brake w/ Lock & Unlock Pedals)</i></p> <p>Available: Wallsavers / Infusion 1511 1514 1811 1814 1855 1865</p> <p>CB-2 \$510 (Set Of 1) <i>(Gray Plastic Brake w/ Lock & Unlock Pedals)</i></p> <p>Available: Layflat 1507-L/T 1513-L/T 1813 L/T 1857 L/T 1867 L/T</p>	
<p>ALUMINUM LEGS</p> 	<p>Overall: 2.25"w 2.25"d 2.25"h</p> <hr/> <p>ASL \$382 (Set Of 4) <i>(Brushed Finish)</i></p> <p>Available: Facelift Replay Patient Chair / Glider (1508 / 1510 Models)</p>	
<p>POWER / DATA MODULE</p>  <p>PM1 Power / Data Module</p>  <p>PM2 Power Module</p>  <p>USB-1 Dual Charging USB</p>	<p>PM1 Overall: 5.25"w 1.25"d 4.25"h PM2 Overall: 2"w 2"d .125"h USB-1 Overall: 2"w 2"d .125"h</p> <hr/> <p>PM1 \$859 Power/Data Module (1-Power / 1-USB 2 Port Simplex Charger Standard) <i>Vertical / Horizontal Mount Power Module. Price Varies By Socket. Contact Customer Service For Quote. (Additional Colors Available)</i></p> <p>PM2 \$238 Power Module (1-Power) <i>Spill-Proof Technology / Multiple Finish Options / Storm Color Standard (Specify Left or Right Facing)</i></p> <p>USB-1 \$238 Dual Charging USB (2 Port Simplex Charger Standard) <i>Spill-Proof Technology / 2 Amps Per Port / Multiple Finish Options / Storm Color Standard (Specify Left or Right Facing)</i></p> <p>Available: Facelift Replay Sleepover Lounge</p>	
<p>ELECTRIC RECLINE / BATTERY BACKUP / HEAT / MASSAGE</p>  <p>ER-1 Electric Recline (Wallsaver Model)</p>  <p>ER-2/ER-3 Electric Recline (Layflat Model)</p>  <p>HM Heat & Massage (All Recliner Models)</p>  <p>H Heat (All Recliner Models)</p>	<p>Overall: N/A</p> <hr/> <p>ER-1 \$1054 Electric Recline <i>Replaces Manual Mechanism On Any Wallsaver Model - Surface Mounts On Inside Arm (Specify Left Or Right Facing)</i> *NOTE: ELECTRIC OPTION NOT AVAILABLE ON INFUSION RECLINERS IN COMBINATION WITH CASTERS.</p> <p>ER-2 \$1087 Electric Recline <i>Replaces Manual Mechanism On Any Layflat Model - Surface Mounts On Inside Arm (Specify Left Or Right Facing)</i></p> <p>ER-3 \$1149 Electric Recline <i>Replaces Manual Mechanism On Any Trendelenburg Layflat Model - Surface Mounts On Inside Arm (Specify Left Or Right Facing)</i></p> <p>BB \$548 Battery Backup <i>Allows Any Wallsaver, Layflat, Or Standup Electric Recliner To Be Cordless - Surface Mounts On Inside Arm (Specify Left Or Right Facing)</i></p> <p>HM \$1500 Heat & Massage <i>Add Heat & Massage To Any Wallsaver, Layflat, Or Standup Electric Recliner - Surface Mounts On Inside Arm (Specify Left Or Right Facing)</i></p> <p>H \$1142 Heat <i>Add Heat Only To Any Wallsaver, Layflat, Or Standup Electric Recliner - Surface Mounts On Inside Arm (Specify Left Or Right Facing)</i></p> <p>Available: Facelift Replay Recliners</p>	
<p>PUSH BAR</p> 	<p>Overall: 18.5"w 3.5"d 1"h</p> <hr/> <p>PB \$267 <i>(Black Finish)</i></p> <p>Available: Facelift Replay Medical Recliners</p>	

I.V. POLE / SIDE TRAY / BAG HOLDER / BUCKLE / FOOTREST	OPTION #:	SPECIFICATIONS LIST PRICES AVAILABILITY:
<p>I.V. POLE</p> 	<p>IV</p> <p>Overall: 10"w 2.5"d 39.5" / 69.75"h</p> <p>\$489 Height Adjustable I.V. Pole (Chrome & Black Finish / Specify Left Or Right Facing Location)</p> <p>Available: Facelift Replay Medical Recliners</p>	
<p>SIDE TRAY / WALLSAVER SIDE TRAY</p>  	<p>Overall: 12.75"w 10"d 4"h (Small Side Tray) / 17"w 10"d 4"h (Large Side Tray)</p> <p>ST-1 \$368 Drop-Down Side Tray (Small Side Tray) <i>NOTE: Attaches Directly To Outside Of Arm</i></p> <p>ST-2 \$415 Drop-Down Side Tray (Large Side Tray) <i>NOTE: Attaches Directly To Outside Of Arm</i></p> <p>Available: Facelift Replay Medical Recliners <i>Note: If A Medical Recliner With A Manual Mechanism Is Selected, The Standard Side Tray Location Will Be Front Right Facing</i></p> <p>WST \$598 Drop-Down Side Tray (Large Side Tray) <i>NOTE: Attaches To Metal Tubing</i></p> <p>Available: Facelift Wallsaver Recliners With Casters Option (1511 / 1811 / 1855)</p>	
<p>BAG HOLDER / PERSONAL RESTRAINT BUCKLE</p> 	<p>Overall: 2.19"w .38"d 2.56"h</p> <p>BH \$86 Bag Holder (Brushed Finish / Specify Left Or Right Facing Location)</p> <p>RB \$133 Pair Personal Restraint Buckle (Brushed Finish)</p> <p>Available: Facelift Replay Medical Recliners</p>	
<p>FOOTREST</p> 	<p>Overall: 16"w 8"d .1875"h</p> <p>FR \$408 (Black Finish)</p> <p>Available: Facelift Replay Medical Recliners</p>	

OXYGEN TANK HOLDER / WOOD RING BASE / COVERS	OPTION #:	SPECIFICATIONS LIST PRICES AVAILABILITY:
<p>OXYGEN TANK HOLDER</p> 	<p>OH</p> <p>Overall: 4.75" Diameter 9.75"h</p> <hr/> <p>\$247 <i>Black Metal Oxygen Tank Holder Holds a 4.375" Diameter Oxygen Tank (Not Included) (Specify Left Or Right Facing Location)</i></p> <p>Available: <i>Facelift Replay Medical Recliners</i></p>	
<p>LOUNGE GLIDER WOOD RING BASE</p> 	<p>WR</p> <p>Overall: 22"dia. 3"h</p> <hr/> <p>\$224 <i>Wood Ring Base replaces circular metal base (1510-G) or swivel glider w/ circular metal base (1510-SG).</i></p> <p><i>Specify Exposed Wood Finish. (See Page 6)</i></p> <p>Available: <i>Facelift Replay Lounge Glider</i></p>	
<p>CONTRASTING COVERS</p> 	<p>CC</p> <p>Overall: N/A</p> <hr/> <p>\$129 <i>NOTE: If Two Or More Upholsteries Or Leathers Are Used On Any Piece Of Furniture, Then A Contrast Charge Will Apply Per Order. When Using Trinity Upholstery, The Higher Priced Upholstery Grade Will Be Used In Pricing, Unless It's Trinity Leather With Fabric Contrast Welt, Or COM With Trinity Contrast Welt, Then Contact Customer Service For Pricing.</i></p> <p>Available: <i>Facelift Replay Healthcare Motion</i></p>	

Facelift Polliwogs

BENCHES / OTTOMANS / TABLES

Effective: March 1, 2025

T R I N I T Y

Date:

Page:

Modification:

Description:

DESCRIPTION:

- Upholstery Frames: Hardwood Plywood
- Seat: High Density Polyurethane Foam Over Hardwood Plywood
- Upholstered Covers: Attached w/ Velcro / Removable For Maintenance
- Antimicrobial Moisture Barrier Fully Encapsulates All Foam Areas
- Round Black Plastic Feet / Removable For Maintenance
- Ganging Connectors Standard
- Leather Upholstery Is Available
- Lifetime Warranty

OPTIONS:

- LC Locking Casters (Set Of 2)\$31
- NLC Non-Locking Casters (Set Of 2).....\$26
- CC Contrasting Covers\$129

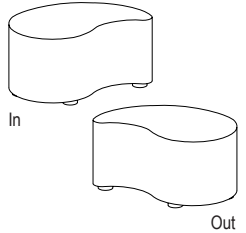
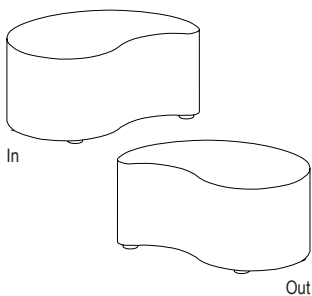
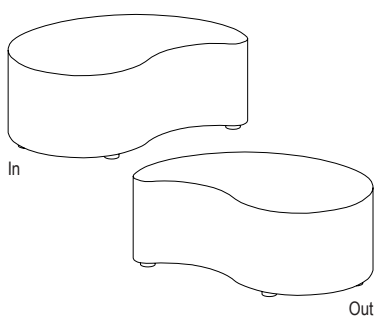
BENCHES		ITEM #:	SPECIFICATIONS GRADES LIST PRICES:														
SMALL BENCH / FULLY UPHOLSTERED			Overall: 18"w 30"d 14"h			Arm: n/a			COM: 2.75 yds.								
			Seat: 14"h			Weight: TBD lbs.			COL: 50 sq.ft.								
			COM	COL	1	2	3	4	5	6	7	8	9	10	L1	L2	
		1540-I	732	805	836	908	980	1052	1125	1197	1269	1341	1413	1485	1570	1830	
			<i>Small Size - In / Tight Seat / Removable Upholstery / 350 lb. Weight Capacity</i>														
		1540-O	732	805	836	908	980	1052	1125	1197	1269	1341	1413	1485	1570	1830	
	<i>Small Size - Out / Tight Seat / Removable Upholstery / 350 lb. Weight Capacity</i>																
	1540-I/O R	169	185	317	396	475	555	634	713	792	871	950	1029	1106	1391		
	<i>Replacement Upholstery Covers</i>																
MEDIUM BENCH / FULLY UPHOLSTERED			Overall: 24"w 40"d 18"h			Arm: n/a			COM: 3.00 yds.								
			Seat: 18"h			Weight: TBD lbs.			COL: 54 sq.ft.								
			COM	COL	1	2	3	4	5	6	7	8	9	10	L1	L2	
		1541-I	1029	1132	1132	1211	1291	1370	1450	1529	1608	1688	1767	1846	1940	2226	
			<i>Medium Size - In / Tight Seat / Removable Upholstery / 350 lb. Weight Capacity</i>														
		1541-O	1029	1132	1132	1211	1291	1370	1450	1529	1608	1688	1767	1846	1940	2226	
	<i>Medium Size - Out / Tight Seat / Removable Upholstery / 350 lb. Weight Capacity</i>																
	1541-I/O R	199	219	362	449	536	623	709	796	883	970	1057	1144	1230	1543		
	<i>Replacement Upholstery Covers</i>																
LARGE BENCH / FULLY UPHOLSTERED			Overall: 30"w 50"d 18"h			Arm: n/a			COM: 3.25 yds.								
			Seat: 18"h			Weight: TBD lbs.			COL: 59 sq.ft.								
			COM	COL	1	2	3	4	5	6	7	8	9	10	L1	L2	
		1542-I	1352	1487	1451	1538	1624	1711	1798	1884	1971	2057	2144	2231	2334	2645	
			<i>Large Size - In / Tight Seat / Removable Upholstery / 350 lb. Weight Capacity</i>														
		1542-O	1352	1487	1451	1538	1624	1711	1798	1884	1971	2057	2144	2231	2334	2645	
	<i>Large Size - Out / Tight Seat / Removable Upholstery / 350 lb. Weight Capacity</i>																
	1542-I/O R	223	245	400	495	590	685	780	875	969	1064	1159	1254	1348	1690		
	<i>Replacement Upholstery Covers</i>																

DESCRIPTION:

- Upholstery Frames: Hardwood Plywood
- Seat: High Density Polyurethane Foam Over Hardwood Plywood
- Upholstered Covers: Attached w/ Velcro / Removable For Maintenance
- Antimicrobial Moisture Barrier Fully Encapsulates All Foam Areas
- Round Black Plastic Feet / Removable For Maintenance
- Ganging Connectors Standard
- Leather Upholstery Is Available
- Lifetime Warranty

OPTIONS:

- LC Locking Casters (Set Of 2)\$44
- NLC Non-Locking Casters (Set Of 2).....\$37
- CC Contrasting Covers\$129

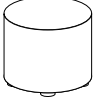
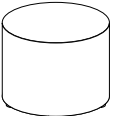
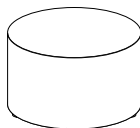
OTTOMANS		ITEM #:	SPECIFICATIONS GRADES LIST PRICES:													
	SMALL ROUND OTTOMAN / FULLY UPHOLSTERED		Overall: 18" Diameter 14"h Seat: 14"h			Arm: n/a Weight: TBD lbs.			COM: 2.00 yds. COL: 36 sq.ft.							
			COM	COL	1	2	3	4	5	6	7	8	9	10	L1	L2
	1543-18D		483	532	558	608	659	709	760	810	861	911	962	1012	1066	1248
			<i>Small Size / Tight Seat / Removable Upholstery / 350 lb. Weight Capacity</i>													
	1543-18DR		102	113	207	263	318	373	429	484	539	595	650	705	756	955
			<i>Replacement Upholstery Covers</i>													
	MEDIUM ROUND OTTOMAN / FULLY UPHOLSTERED		Overall: 24" Diameter 18"h Seat: 18"h			Arm: n/a Weight: 46 lbs.			COM: 2.25 yds. COL: 41 sq.ft.							
			COM	COL	1	2	3	4	5	6	7	8	9	10	L1	L2
	1543-24D		738	812	813	871	929	986	1044	1102	1159	1217	1275	1333	1394	1602
			<i>Medium Size / Tight Seat / Removable Upholstery / 350 lb. Weight Capacity</i>													
	1543-24DR		120	132	240	303	366	429	492	556	619	682	745	809	866	1094
			<i>Replacement Upholstery Covers</i>													
	LARGE ROUND OTTOMAN / FULLY UPHOLSTERED		Overall: 30" Diameter 18"h Seat: 18"h			Arm: n/a Weight: TBD lbs.			COM: 2.50 yds. COL: 45 sq.ft.							
			COM	COL	1	2	3	4	5	6	7	8	9	10	L1	L2
	1543-30D		868	955	951	1016	1081	1146	1211	1276	1341	1406	1471	1535	1606	1840
			<i>Large Size / Tight Seat / Removable Upholstery / 350 lb. Weight Capacity</i>													
	1543-30DR		144	158	278	349	420	492	563	634	705	776	847	918	984	1240
			<i>Replacement Upholstery Covers</i>													

DESCRIPTION:

- Upholstery Frames: Hardwood Plywood
- Table Top: High Pressure Laminate Top Over Plywood Core
- Upholstered Covers: Attached w/ Velcro / Removable For Maintenance
- Antimicrobial Moisture Barrier Fully Encapsulates All Foam Areas
- Round Black Plastic Feet / Removable For Maintenance
- Ganging Connectors Standard
- Leather Upholstery Is Available
- Lifetime Warranty

OPTIONS:

- SE18D Self Edge Table Top - 18" Diameter.....\$38
- SE24D Self Edge Table Top - 24" Diameter.....\$38
- SE30D Self Edge Table Top - 30" Diameter.....\$38
- LC Locking Casters (Set Of 2).....\$44
- NLC Non-Locking Casters (Set Of 2).....\$37
- CC Contrasting Covers.....\$129

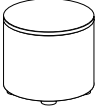
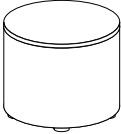
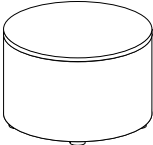
TABLES		ITEM #:	SPECIFICATIONS GRADES LIST PRICES:												
	SMALL ROUND TABLE / UPHOLSTERED BASE		Overall: 18" Diameter 14"h				Arm: n/a				COM: 1.25 yds.				
			Seat: 14"h				Weight: TBD lbs.				COL: 23 sq.ft.				
			COM	COL	1	2	3	4	5	6	7	8	9	10	L1
	1544-18T	594	654	620	649	677	706	735	764	793	822	851	879	918	1022
		<i>Small Size / High Pressure Laminate Top / Removable Upholstery</i>													
	1544-18TR	102	113	160	192	223	255	287	318	350	381	413	445	478	592
		<i>Replacement Upholstery Covers</i>													
	MEDIUM ROUND TABLE / UPHOLSTERED BASE		Overall: 24" Diameter 18"h				Arm: n/a				COM: 1.50 yds.				
			Seat: 18"h				Weight: TBD lbs.				COL: 27 sq.ft.				
			COM	COL	1	2	3	4	5	6	7	8	9	10	L1
	1544-24T	900	990	923	959	995	1032	1068	1104	1140	1176	1212	1248	1294	1424
		<i>Medium Size / High Pressure Laminate Top / Removable Upholstery</i>													
	1544-24TR	120	132	192	232	271	311	350	390	429	469	508	548	589	731
		<i>Replacement Upholstery Covers</i>													
	LARGE ROUND TABLE / UPHOLSTERED BASE		Overall: 30" Diameter 18"h				Arm: n/a				COM: 1.75 yds.				
			Seat: 18"h				Weight: TBD lbs.				COL: 32 sq.ft.				
			COM	COL	1	2	3	4	5	6	7	8	9	10	L1
	1544-30T	1070	1177	1084	1120	1156	1192	1228	1264	1300	1336	1372	1408	1037	1589
		<i>Large Size / High Pressure Laminate Top / Removable Upholstery</i>													
	1544-30TR	144	158	231	278	326	373	420	468	515	563	610	658	152	757
		<i>Replacement Upholstery Covers</i>													

DESCRIPTION:

- Upholstery Frames: Hardwood Plywood
- Table Top: High Pressure Laminate Top Over Plywood Core
- Upholstered Covers: Attached w/ Velcro / Removable For Maintenance
- Antimicrobial Moisture Barrier Fully Encapsulates All Foam Areas
- Round Black Plastic Feet / Removable For Maintenance
- Ganging Connectors Standard
- Leather Upholstery Is Available
- Lifetime Warranty

OPTIONS:

- SE18D Self Edge Table Top - 18" Diameter.....\$38
- SE24D Self Edge Table Top - 24" Diameter.....\$38
- SE30D Self Edge Table Top - 30" Diameter.....\$38
- LC Locking Casters (Set Of 2).....\$44
- NLC Non-Locking Casters (Set Of 2).....\$37
- CC Contrasting Covers.....\$129

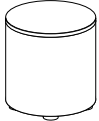
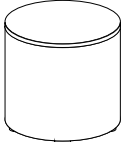
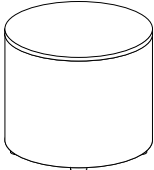
TABLES		ITEM #:	SPECIFICATIONS GRADES LIST PRICES:													
<p>TALL SMALL ROUND TABLE / UPHOLSTERED BASE</p> 		Overall: 18" Diameter 18"h Seat: 18"h	Arm: n/a Weight: 35 lbs.	COM: 1.25 yds. COL: 23 sq.ft.												
	1545-18T	COM	COL	1	2	3	4	5	6	7	8	9	10	L1	L2	
		651	716	673	702	731	759	788	817	846	875	904	933	973	1077	
		<i>Small Size / High Pressure Laminate Top / Removable Upholstery</i>														
	1545-18TR	COM	COL	1	2	3	4	5	6	7	8	9	10	L1	L2	
		109	120	167	198	230	262	293	325	356	388	420	451	486	600	
		<i>Replacement Upholstery Covers</i>														
<p>TALL MEDIUM ROUND TABLE / UPHOLSTERED BASE</p> 		Overall: 24" Diameter 24"h Seat: 24"h	Arm: n/a Weight: TBD lbs.	COM: 1.50 yds. COL: 27 sq.ft.												
	1545-24T	COM	COL	1	2	3	4	5	6	7	8	9	10	L1	L2	
		810	891	838	874	910	946	982	1018	1054	1091	1127	1163	1211	1341	
		<i>Medium Size / High Pressure Laminate Top / Removable Upholstery</i>														
	1545-24TR	COM	COL	1	2	3	4	5	6	7	8	9	10	L1	L2	
		127	139	199	238	278	317	357	396	436	475	515	554	597	739	
		<i>Replacement Upholstery Covers</i>														
<p>TALL LARGE ROUND TABLE / UPHOLSTERED BASE</p> 		Overall: 30" Diameter 24"h Seat: 24"h	Arm: n/a Weight: TBD lbs.	COM: 1.75 yds. COL: 32 sq.ft.												
	1545-30T	COM	COL	1	2	3	4	5	6	7	8	9	10	L1	L2	
		1090	1199	1117	1160	1203	1247	1290	1333	1377	1420	1463	1506	1564	1720	
		<i>Large Size / High Pressure Laminate Top / Removable Upholstery</i>														
	1545-30TR	COM	COL	1	2	3	4	5	6	7	8	9	10	L1	L2	
		151	166	237	285	332	380	427	475	522	569	617	664	715	886	
		<i>Replacement Upholstery Covers</i>														

CONFIGURATION EXAMPLES:

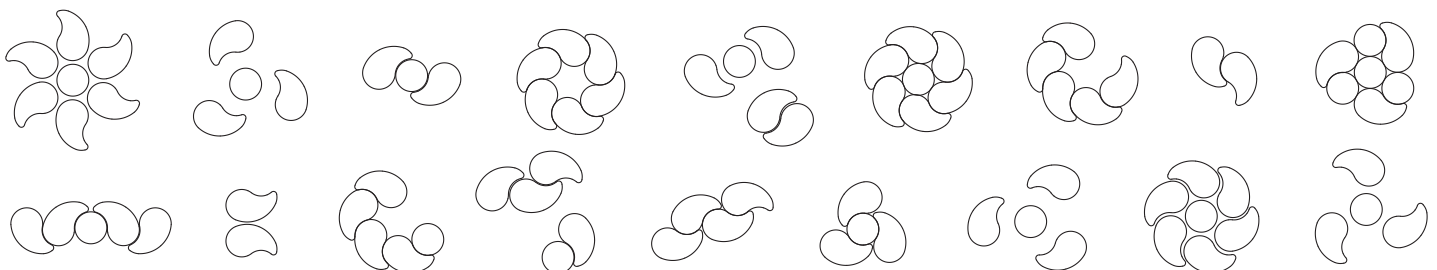

POWER / COVERS	OPTION #:	SPECIFICATIONS LIST PRICES AVAILABILITY:								
<p>LOCKING / NON-LOCKING CASTERS</p>  <p>Locking Casters</p>  <p>Non-Locking Casters</p>	<p>Overall: 1.875"w 2.25"d 1.5"h (Locking) / 1.875"w 1.625"d 1.5"h (Non-Locking)</p> <hr/> <p>LC \$44 (Set Of Two) <i>Locking Casters (Black Finish / Specify Location)</i></p> <p>NLC \$37 (Set Of Two) <i>Non-Locking Casters (Black Finish / Specify Location)</i></p> <p>Available: <i>Facelift Polliwogs Collection</i></p>									
<p>SELF EDGE TABLE TOP</p> 	<p>Overall: 18" Diameter x 1"h / 24" Diameter x 1"h / 30" Diameter x 1"h</p> <hr/> <table border="0"> <tr> <td data-bbox="493 730 553 758">SE18D</td> <td data-bbox="581 730 1057 758">Self Edge Table Top - 18" Diameter</td> <td data-bbox="1068 730 1105 758">\$38</td> </tr> <tr> <td data-bbox="493 779 553 806">SE24D</td> <td data-bbox="581 779 1057 806">Self Edge Table Top - 24" Diameter</td> <td data-bbox="1068 779 1105 806">\$38</td> </tr> <tr> <td data-bbox="493 827 553 854">SE30D</td> <td data-bbox="581 827 1057 854">Self Edge Table Top - 30" Diameter</td> <td data-bbox="1068 827 1105 854">\$38</td> </tr> </table> <p><i>High Pressure Laminate Top w/ Self Edge</i></p> <p>Available: <i>Facelift Polliwogs Tables</i></p>	SE18D	Self Edge Table Top - 18" Diameter	\$38	SE24D	Self Edge Table Top - 24" Diameter	\$38	SE30D	Self Edge Table Top - 30" Diameter	\$38
SE18D	Self Edge Table Top - 18" Diameter	\$38								
SE24D	Self Edge Table Top - 24" Diameter	\$38								
SE30D	Self Edge Table Top - 30" Diameter	\$38								
<p>CONTRASTING COVERS</p> 	<p>Overall: N/A</p> <hr/> <p>CC \$129</p> <p><i>NOTE: If Two Or More Upholsteries Or Leathers Are Used On Any Piece Of Furniture, Then A Contrast Charge Will Apply Per Order. When Using Trinity Upholstery, The Higher Priced Upholstery Grade Will Be Used In Pricing, Unless It's Trinity Leather With Fabric Contrast Welt, Or COM With Trinity Contrast Welt, Then Contact Customer Service For Pricing.</i></p> <p>Available: <i>Facelift Polliwogs Collection</i></p>									

Facelift Fair & Square

LOUNGE / TANDEM / BENCHES / TABLES

Effective: March 1, 2025

T R I N I T Y

Date:

Page:

Modification:

Description:

DESCRIPTION:

- Upholstery Frames: Plywood & Hardwood
- Seat: High Density Polyurethane Foam Over Sheet Webbing
- Upholstered Covers: Attached w/ Velcro / Removable For Maintenance
- Antimicrobial Moisture Barrier Fully Encapsulates All Foam Areas
- Ganging Straps Standard
- Brushed Aluminum Round Legs / Removable For Maintenance
- Leather Upholstery Is Available
- Lifetime Warranty

OPTIONS:

- USB-1 USB In Back (2 Ports Available - Specify Left or Right Facing).....\$238
- PM2 Power Module (1-Power - Specify Left or Right Facing).....\$238

Feather Down & Polyester Pillows Available (See Page 5)

NOTE: Additional Seaming May Be Required If Fabric Is Railroaded.

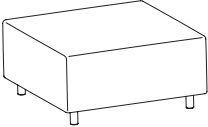
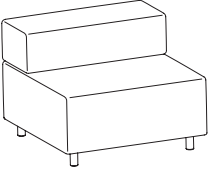
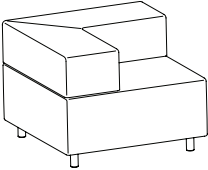
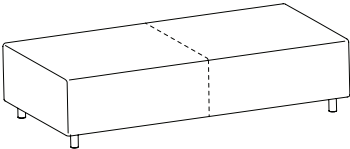
TANDEM		ITEM #:	SPECIFICATIONS GRADES LIST PRICES:													
			Overall: 36"w 36"d 18"h			Arm: n/a			COM: 2.5 yds.							
			Seat: 36"w 36"d 18"h			Weight: 62 lbs.			COL: 45 sq.ft.							
			COM	COL	1	2	3	4	5	6	7	8	9	10	L1	L2
	1550		1051	1156	1195	1296	1397	1498	1599	1700	1801	1902	2004	2105	2199	2563
			<i>Tight Seat / Removable Upholstery / 500 lb. Weight Capacity</i>													
	1550-R		135	148	269	341	412	483	554	625	696	767	839	910	975	1231
			<i>Replacement Upholstery Covers</i>													
			Overall: 36"w 36"d 28"h			Arm: n/a			COM: 3.25 yds.							
			Seat: 36"w 22"d 18"h			Weight: 70 lbs.			COL: 59 sq.ft.							
			COM	COL	1	2	3	4	5	6	7	8	9	10	L1	L2
	1551		1461	1607	1555	1641	1728	1815	1901	1988	2074	2161	2248	2334	2428	2740
			<i>Tight Seat & Back / Removable Upholstery / 500 lb. Weight Capacity</i>													
	1551-R		184	203	364	459	554	648	743	838	933	1028	1123	1218	1304	1645
			<i>Replacement Upholstery Covers</i>													
			Overall: 36"w 36"d 28"h			Arm: n/a			COM: 4 yds.							
			Seat: 36"w 22"d 18"h			Weight: 74 lbs.			COL: 72 sq.ft.							
			COM	COL	1	2	3	4	5	6	7	8	9	10	L1	L2
	1552		1673	1840	1798	1906	2014	2123	2231	2339	2447	2556	2664	2772	2892	3281
			<i>Tight Seat & Back / Removable Upholstery / 500 lb. Weight Capacity</i>													
	1552-R		243	267	467	585	704	822	941	1059	1178	1297	1415	1534	1645	2072
			<i>Replacement Upholstery Covers</i>													
			Overall: 72"w 36"d 18"h			Arm: n/a			COM: 4.5 yds.							
			Seat: 72"w 36"d 18"h			Weight: 121 lbs.			COL: 81 sq.ft.							
			COM	COL	1	2	3	4	5	6	7	8	9	10	L1	L2
	1555		1525	1677	1687	1809	1932	2055	2177	2300	2423	2545	2668	2791	2909	3351
			<i>Tight Seat / Removable Upholstery / 750 lb. Weight Capacity</i>													
	1555-R		208	229	465	599	734	868	1003	1137	1271	1406	1540	1674	1787	2271
			<i>Replacement Upholstery Covers</i>													

DESCRIPTION:

- Upholstery Frames: Plywood & Hardwood
- Seat: High Density Polyurethane Foam Over Sheet Webbing
- Upholstered Covers: Attached w/ Velcro / Removable For Maintenance
- Antimicrobial Moisture Barrier Fully Encapsulates All Foam Areas
- Ganging Straps Standard
- Brushed Aluminum Round Legs / Removable For Maintenance
- Leather Upholstery Is Available
- Lifetime Warranty

OPTIONS:

- USB-1 USB In Back (2 Ports Available - Specify Left or Right Facing).....\$238
- PM2 Power Module (1-Power - Specify Left or Right Facing).....\$238

Feather Down & Polyester Pillows Available (See Page 5)

NOTE: Additional Seaming May Be Required If Fabric Is Railroaded.

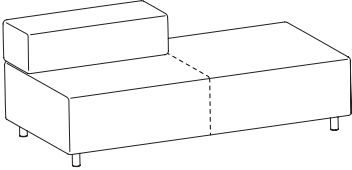
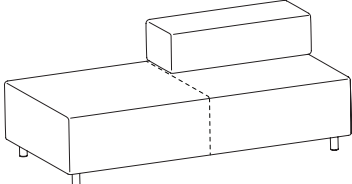
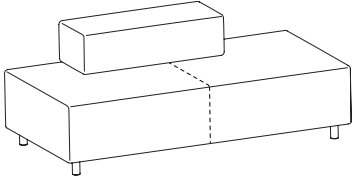
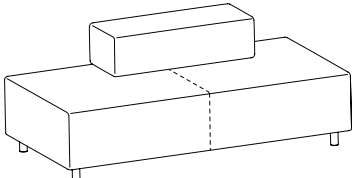
TANDEM		ITEM #:	SPECIFICATIONS GRADES LIST PRICES:													
		1556	Overall: 72"w 36"d 28"h			Arm: n/a			COM: 5.25 yds.							
			Seat: 72"w 22"/36"d 18"h			Weight: 129 lbs.			COL: 95 sq.ft.							
			COM	COL	1	2	3	4	5	6	7	8	9	10	L1	L2
			2063	2269	2239	2383	2527	2672	2816	2960	3105	3249	3393	3538	3683	4203
			<i>Tight Seat & Back / Removable Upholstery / 750 lb. Weight Capacity</i>													
		1556-R	271	298	573	731	889	1047	1205	1363	1521	1679	1837	1995	2131	2700
			<i>Replacement Upholstery Covers</i>													
		1557	Overall: 72"w 36"d 28"h			Arm: n/a			COM: 5.25 yds.							
			Seat: 72"w 22"/36"d 18"h			Weight: 129 lbs.			COL: 95 sq.ft.							
			COM	COL	1	2	3	4	5	6	7	8	9	10	L1	L2
			2063	2269	2239	2383	2527	2672	2816	2960	3105	3249	3393	3538	3683	4203
			<i>Tight Seat & Back / Removable Upholstery / 750 lb. Weight Capacity</i>													
		1557-R	271	298	573	731	889	1047	1205	1363	1521	1679	1837	1995	2131	2700
			<i>Replacement Upholstery Covers</i>													
		1558	Overall: 72"w 36"d 28"h			Arm: n/a			COM: 5.25 yds.							
			Seat: 72"w 22"d 18"h			Weight: 129 lbs.			COL: 95 sq.ft.							
			COM	COL	1	2	3	4	5	6	7	8	9	10	L1	L2
			2069	2276	2245	2389	2533	2678	2822	2966	3110	3255	3399	3543	3689	4208
			<i>Tight Seat & Back / Removable Upholstery / 750 lb. Weight Capacity</i>													
		1558-R	271	298	573	731	889	1047	1205	1363	1521	1679	1837	1995	2131	2700
			<i>Replacement Upholstery Covers</i>													
		1559	Overall: 72"w 36"d 28"h			Arm: n/a			COM: 5.25 yds.							
			Seat: 72"w 22"d 18"h			Weight: 129 lbs.			COL: 95 sq.ft.							
			COM	COL	1	2	3	4	5	6	7	8	9	10	L1	L2
			2069	2276	2245	2389	2533	2678	2822	2966	3110	3255	3399	3543	3689	4208
			<i>Tight Seat & Back / Removable Upholstery / 750 lb. Weight Capacity</i>													
		1559-R	271	298	573	731	889	1047	1205	1363	1521	1679	1837	1995	2131	2700
			<i>Replacement Upholstery Covers</i>													

DESCRIPTION:

- Upholstery Frames: Plywood & Hardwood
- Seat: High Density Polyurethane Foam Over Sheet Webbing
- Upholstered Covers: Attached w/ Velcro / Removable For Maintenance
- Antimicrobial Moisture Barrier Fully Encapsulates All Foam Areas
- Ganging Straps Standard
- Brushed Aluminum Round Legs / Removable For Maintenance
- Leather Upholstery Is Available
- Lifetime Warranty

OPTIONS:

- USB-1 USB In Back (2 Ports Available - Specify Left or Right Facing).....\$238
- PM2 Power Module (1-Power - Specify Left or Right Facing).....\$238

Feather Down & Polyester Pillows Available (See Page 5)

NOTE: Additional Seaming May Be Required If Fabric Is Railroaded.

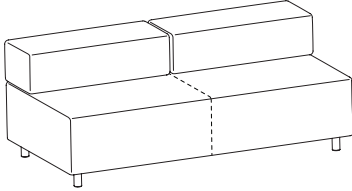
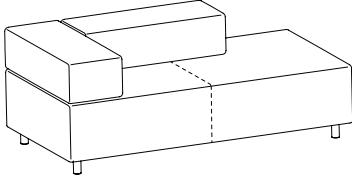
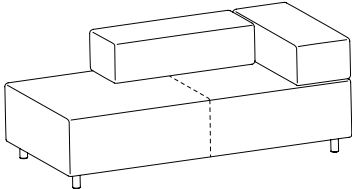
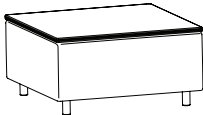
TANDEM	ITEM #:	SPECIFICATIONS GRADES LIST PRICES:													
		Overall: 72"w 36"d 28"h		Arm: n/a					COM: 6 yds.						
		Seat: 72"w 22"d 18"h		Weight: 137 lbs.					COL: 108 sq.ft.						
		COM	COL	1	2	3	4	5	6	7	8	9	10	L1	L2
	1560	2439	2683	2638	2804	2970	3136	3302	3468	3634	3800	3966	4132	4318	4915
		<i>Tight Seat & Back / Removable Upholstery / 750 lb. Weight Capacity</i>													
	1560-R	294	323	641	823	1005	1187	1369	1550	1732	1914	2096	2277	2435	3090
		<i>Replacement Upholstery Covers</i>													
		Overall: 72"w 36"d 28"h		Arm: n/a					COM: 6 yds.						
		Seat: 72"w 22"/36"d 18"h		Weight: 137 lbs.					COL: 108 sq.ft.						
		COM	COL	1	2	3	4	5	6	7	8	9	10	L1	L2
	1561	2476	2724	2673	2839	3005	3171	3337	3503	3669	3835	4001	4167	4352	4950
		<i>Tight Seat & Back / Removable Upholstery / 750 lb. Weight Capacity</i>													
	1561-R	294	323	641	823	1005	1187	1369	1550	1732	1914	2096	2277	2435	3090
		<i>Replacement Upholstery Covers</i>													
		Overall: 72"w 36"d 28"h		Arm: n/a					COM: 6 yds.						
		Seat: 72"w 22"/36"d 18"h		Weight: 137 lbs.					COL: 108 sq.ft.						
		COM	COL	1	2	3	4	5	6	7	8	9	10	L1	L2
	1562	2476	2724	2673	2839	3005	3171	3337	3503	3669	3835	4001	4167	4352	4950
		<i>Tight Seat & Back / Removable Upholstery / 750 lb. Weight Capacity</i>													
	1562-R	294	323	641	823	1005	1187	1369	1550	1732	1914	2096	2277	2435	3090
		<i>Replacement Upholstery Covers</i>													
		Overall: 36"w 36"d 19"h		Arm: n/a					COM: 2.25 yds.						
		Seat: n/a		Weight: 103 lbs.					COL: 41 sq.ft.						
		COM	COL	1	2	3	4	5	6	7	8	9	10	L1	L2
	1564-L	1509	1659	1542	1599	1657	1715	1773	1830	1888	1946	2004	2061	2125	2333
		<i>High Pressure Laminate Face / Multi-Ply Edge</i>													
	1564-R	135	148	269	341	412	483	554	625	696	767	839	910	975	1231
		<i>Replacement Upholstery Covers</i>													

Configuration Examples

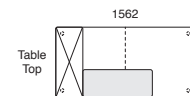
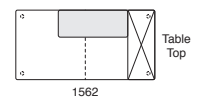
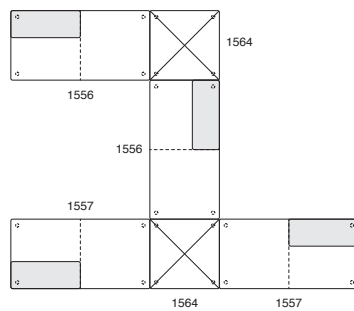
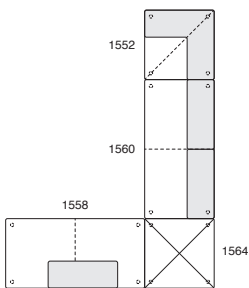
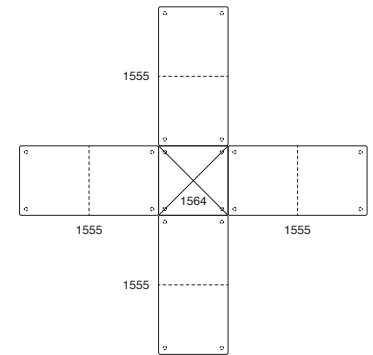
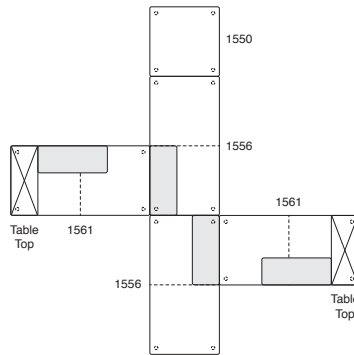
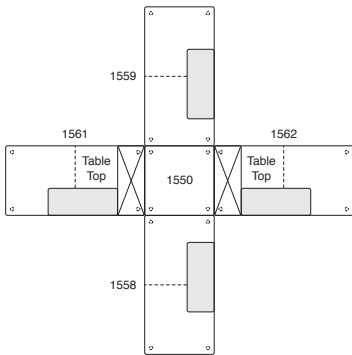
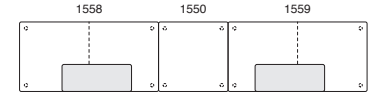
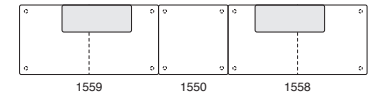
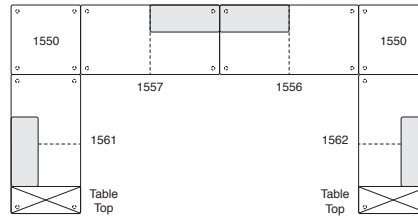
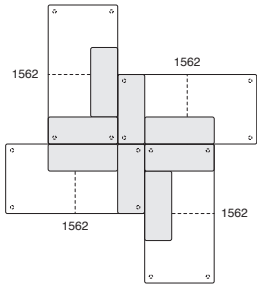
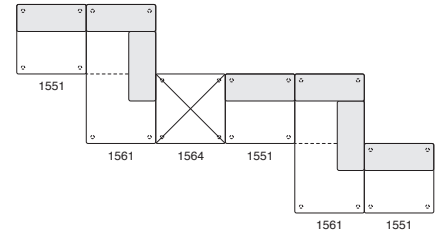
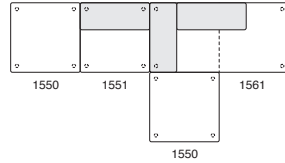
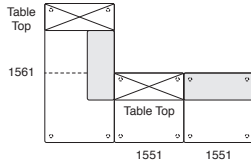

POWER / COVERS	OPTION #:	SPECIFICATIONS LIST PRICES AVAILABILITY:
<p>DUAL CHARGING USB</p> 	<p>USB-1</p>	<p>Overall: 2"w 2"d .1875"h</p> <hr/> <p>\$238 (Per Arm) <i>Spill-Proof Technology / 2 Amps Per Port / Multiple Finish Options / Storm Color Standard (Specify Left or Right Facing)</i></p> <p>Available: <i>Facelift Fair & Square Collection</i></p>
<p>POWER MODULE</p> 	<p>PM2</p>	<p>PM2 Overall: 2"w 2"d .125"h</p> <hr/> <p>\$238 Power Module (1-Power) <i>Spill-Proof Technology / Multiple Finish Options / Storm Color Standard (Specify Left or Right Facing)</i></p> <p>Available: <i>Facelift Fair & Square Collection</i></p>
<p>CONTRASTING COVERS</p> 	<p>CC</p>	<p>Overall: N/A</p> <hr/> <p>\$129 <i>NOTE: If Two Or More Upholsteries Or Leathers Are Used On Any Piece Of Furniture, Then A Contrast Charge Will Apply Per Order. When Using Trinity Upholstery, The Higher Priced Upholstery Grade Will Be Used In Pricing, Unless It's Trinity Leather With Fabric Contrast Welt, Or COM With Trinity Contrast Welt, Then Contact Customer Service For Pricing.</i></p> <p>Available: <i>Facelift Fair & Square Collection</i></p>

Facelift Serpentine

LOUNGE / TANDEM / BENCHES / TABLES

Effective: March 1, 2025

T R I N I T Y

Date:

Page:

Modification:

Description:

DESCRIPTION:

- Upholstery Frames: Plywood & Hardwood
- Seat: High Density Polyurethane Foam Over Sheet Webbing
- Back: High Density Polyurethane Foam Over Strap Webbing
- Upholstered Covers: Attached w/ Velcro / Removable For Maintenance
- Antimicrobial Moisture Barrier Fully Encapsulates All Foam Areas
- Ganging Straps Standard
- Brushed Aluminum Round Legs Standard / Removable For Maintenance
- Leather Upholstery Is Not Available
- Lifetime Warranty

OPTIONS:

(See Facelift Serpentine Options Pages)

Feather Down & Polyester Pillows Available (See Page 5)

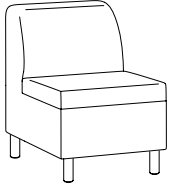
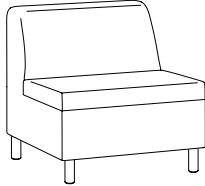
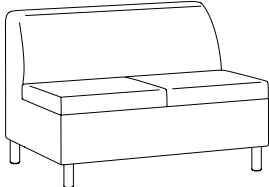
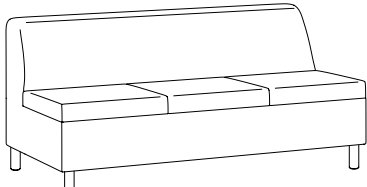
LOUNGE / TANDEM	ITEM #:	SPECIFICATIONS GRADES LIST PRICES:													
STRAIGHT LOUNGE SECTION / FULLY UPHOLSTERED 		Overall: 22"w 30"d 32"h		Arm: n/a		COM: 2.5 yds.									
		Seat: 22"w 19.5"d 18"h		Weight: 45 lbs.		COL: n/a									
		COM	COL	1	2	3	4	5	6	7	8	9	10	L1	L2
	1571	1156	N/A	1219	1282	1345	1409	1472	1535	1598	1661	1724	1787	N/A	N/A
		<i>Tight Seat & Back / Removable Upholstery / 500 lb. Weight Capacity</i>													
	1571-R	199	N/A	337	411	485	559	634	708	782	856	931	1005	N/A	N/A
		<i>Replacement Upholstery Covers</i>													
STRAIGHT BARIATRIC LOUNGE SECTION / FULLY UPHOLSTERED 		Overall: 30"w 30"d 32"h		Arm: n/a		COM: 3 yds.									
		Seat: 30"w 19.5"d 18"h		Weight: 65 lbs.		COL: n/a									
		COM	COL	1	2	3	4	5	6	7	8	9	10	L1	L2
	1571-X	1263	N/A	1348	1425	1502	1580	1657	1734	1811	1888	1965	2042	N/A	N/A
		<i>Tight Seat & Back / Removable Upholstery / 500 lb. Weight Capacity</i>													
	1571-XR	206	N/A	376	467	558	649	739	830	921	1011	1102	1193	N/A	N/A
		<i>Replacement Upholstery Covers</i>													
STRAIGHT TWO PLACE LOUNGE SECTION / FULLY UPHOLSTERED 		Overall: 44"w 30"d 32"h		Arm: n/a		COM: 4.25 yds.									
		Seat: 44"w 19.5"d 18"h		Weight: 80 lbs.		COL: n/a									
		COM	COL	1	2	3	4	5	6	7	8	9	10	L1	L2
	1572	1783	N/A	1910	2022	2134	2246	2358	2470	2583	2695	2807	2919	N/A	N/A
		<i>Tight Seat & Back / Removable Upholstery / 750 lb. Weight Capacity</i>													
	1572-R	218	N/A	470	602	734	866	998	1130	1262	1394	1526	1658	N/A	N/A
		<i>Replacement Upholstery Covers</i>													
STRAIGHT THREE PLACE LOUNGE SECTION / FULLY UPHOLSTERED 		Overall: 66"w 30"d 32"h		Arm: n/a		COM: 5.5 yds.									
		Seat: 66"w 19.5"d 18"h		Weight: 95 lbs.		COL: n/a									
		COM	COL	1	2	3	4	5	6	7	8	9	10	L1	L2
	1573	2441	N/A	2603	2750	2897	3044	3192	3339	3486	3633	3780	3928	N/A	N/A
		<i>Tight Seat & Back / Removable Upholstery / 1000 lb. Weight Capacity</i>													
	1573-R	286	N/A	617	790	963	1136	1309	1483	1656	1829	2002	2175	N/A	N/A
		<i>Replacement Upholstery Covers</i>													

DESCRIPTION:

- Upholstery Frames: Plywood & Hardwood
- Seat: High Density Polyurethane Foam Over Sheet Webbing
- Back: High Density Polyurethane Foam Over Strap Webbing
- Upholstered Covers: Attached w/ Velcro / Removable For Maintenance
- Antimicrobial Moisture Barrier Fully Encapsulates All Foam Areas
- Ganging Straps Standard
- Brushed Aluminum Round Legs Standard / Removable For Maintenance
- Leather Upholstery Is Not Available
- Lifetime Warranty

OPTIONS:

(See Facelift Serpentine Options Pages)

Feather Down & Polyester Pillows Available (See Page 5)

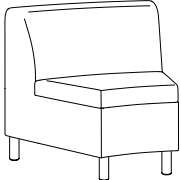
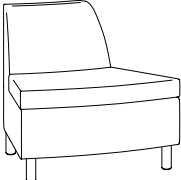
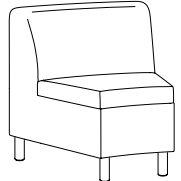
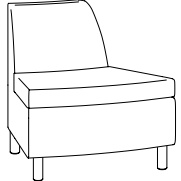
TANDEM	ITEM #:	SPECIFICATIONS GRADES LIST PRICES:													
		Overall: 34"w 30"d 32"h		Arm: n/a		COM: 3.25 yds.									
		Seat: 28"w 19.5"d 18"h		Weight: 50 lbs.		COL: n/a									
		COM	COL	1	2	3	4	5	6	7	8	9	10	L1	L2
	1574	1393	N/A	1486	1570	1654	1738	1822	1906	1990	2075	2159	2243	N/A	N/A
		<i>Tight Seat & Back / 60" Radius / Removable Upholstery / 500 lb. Weight Capacity</i>													
	1574-R	221	N/A	407	506	605	704	803	902	803	877	951	1025	N/A	N/A
		<i>Replacement Upholstery Covers</i>													
		Overall: 34"w 30"d 32"h		Arm: n/a		COM: 3.25 yds.									
		Seat: 34"w 19.5"d 18"h		Weight: 45 lbs.		COL: n/a									
		COM	COL	1	2	3	4	5	6	7	8	9	10	L1	L2
	1575	1319	N/A	1415	1499	1583	1667	1752	1836	1920	2004	2088	2172	N/A	N/A
		<i>Tight Seat & Back / 60" Radius / Removable Upholstery / 500 lb. Weight Capacity</i>													
	1575-R	203	N/A	390	489	588	687	786	885	983	1082	1181	1280	N/A	N/A
		<i>Replacement Upholstery Covers</i>													
		Overall: 32"w 30"d 32"h		Arm: n/a		COM: 2.75 yds.									
		Seat: 25.5"w 19.5"d 18"h		Weight: 50 lbs.		COL: n/a									
		COM	COL	1	2	3	4	5	6	7	8	9	10	L1	L2
	1576	1269	N/A	1340	1410	1480	1550	1620	1690	1761	1831	1901	1971	N/A	N/A
		<i>Tight Seat & Back / 30" Radius / Removable Upholstery / 500 lb. Weight Capacity</i>													
	1576-R	214	N/A	367	450	532	615	697	780	862	944	1027	1109	N/A	N/A
		<i>Replacement Upholstery Covers</i>													
		Overall: 32"w 30"d 32"h		Arm: n/a		COM: 2.75 yds.									
		Seat: 32"w 19.5"d 18"h		Weight: 45 lbs.		COL: n/a									
		COM	COL	1	2	3	4	5	6	7	8	9	10	L1	L2
	1577	1236	N/A	1309	1379	1449	1519	1589	1659	1729	1799	1869	1939	N/A	N/A
		<i>Tight Seat & Back / 30" Radius / Removable Upholstery / 500 lb. Weight Capacity</i>													
	1577-R	196	N/A	350	433	515	598	680	762	1571	1744	1917	2090	N/A	N/A
		<i>Replacement Upholstery Covers</i>													

DESCRIPTION:

- Upholstery Frames: Plywood & Hardwood
- Seat: High Density Polyurethane Foam Over Sheet Webbing
- Back: High Density Polyurethane Foam Over Strap Webbing
- Upholstered Covers: Attached w/ Velcro / Removable For Maintenance
- Antimicrobial Moisture Barrier Fully Encapsulates All Foam Areas
- Ganging Straps Standard
- Brushed Aluminum Round Legs Standard / Removable For Maintenance
- Leather Upholstery Is Not Available
- Lifetime Warranty

OPTIONS:

(See Facelift Serpentine Options Pages)

Feather Down & Polyester Pillows Available (See Page 5)

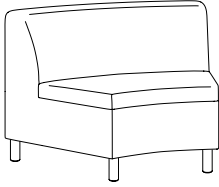
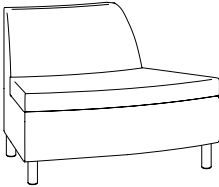
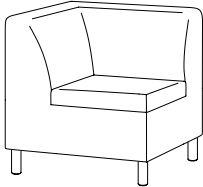
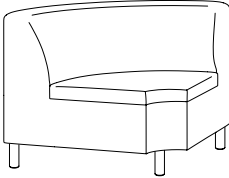
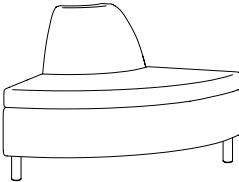
TANDEM		ITEM #:	SPECIFICATIONS GRADES LIST PRICES:													
			Overall: 46.5"w 30"d 32"h			Arm: n/a			COM: 3.5 yds.							
			Seat: 37.5"w 19.5"d 18"h			Weight: 50 lbs.			COL: n/a							
			COM	COL	1	2	3	4	5	6	7	8	9	10	L1	L2
	1578		1730	N/A	1817	1909	2000	2091	2182	2273	2364	2455	2546	2638	N/A	N/A
			<i>Tight Seat & Back / 30" Radius / Removable Upholstery / 500 lb. Weight Capacity</i>													
	1578-R		250	N/A	450	558	665	772	879	986	1094	1201	1308	1415	N/A	N/A
			<i>Replacement Upholstery Covers</i>													
			Overall: 46.5"w 30"d 32"h			Arm: n/a			COM: 3.25 yds.							
			Seat: 46.5"w 19.5"d 18"h			Weight: 50 lbs.			COL: n/a							
			COM	COL	1	2	3	4	5	6	7	8	9	10	L1	L2
	1579		1664	N/A	1742	1826	1910	1994	2078	2162	2246	2331	2415	2499	N/A	N/A
			<i>Tight Seat & Back / 30" Radius / Removable Upholstery / 500 lb. Weight Capacity</i>													
	1579-R		250	N/A	434	533	632	731	830	929	1028	1127	1226	1325	N/A	N/A
			<i>Replacement Upholstery Covers</i>													
			Overall: 30"w 30"d 32"h			Arm: n/a			COM: 3.5 yds.							
			Seat: 19.5"w 19.5"d 18"h			Weight: 80 lbs.			COL: n/a							
			COM	COL	1	2	3	4	5	6	7	8	9	10	L1	L2
	1580		1734	N/A	1766	1829	1892	1955	2018	2081	2144	2207	2270	2333	N/A	N/A
			<i>Tight Seat & Back / Removable Upholstery / 500 lb. Weight Capacity</i>													
	1580-R		283	N/A	531	663	795	927	1059	1191	861	935	1010	1084	N/A	N/A
			<i>Replacement Upholstery Covers</i>													
			Overall: 51"w 33"d 32"h			Arm: n/a			COM: 4 yds.							
			Seat: 37.5"w 19.5"d 18"h			Weight: 70 lbs.			COL: n/a							
			COM	COL	1	2	3	4	5	6	7	8	9	10	L1	L2
	1581		2006	N/A	2107	2212	2318	2423	2528	2633	2738	2843	2949	3054	N/A	N/A
			<i>Tight Seat & Back / 6" Radius / Removable Upholstery / 500 lb. Weight Capacity</i>													
	1581-R		268	N/A	418	500	583	665	748	830	913	995	1078	1160	N/A	N/A
			<i>Replacement Upholstery Covers</i>													
			Overall: 51"w 33"d 32"h			Arm: n/a			COM: 4 yds.							
			Seat: 51"w 19.5"d 18"h			Weight: 70 lbs.			COL: n/a							
			COM	COL	1	2	3	4	5	6	7	8	9	10	L1	L2
	1582		1806	N/A	1917	2022	2128	2233	2338	2443	2548	2653	2759	2864	N/A	N/A
			<i>Tight Seat & Back / 6" Radius / Removable Upholstery / 500 lb. Weight Capacity</i>													
	1582-R		256	N/A	457	564	671	778	885	993	1100	1207	1314	1421	N/A	N/A
			<i>Replacement Upholstery Covers</i>													

DESCRIPTION:

- Upholstery Frames: Plywood & Hardwood
- Seat: High Density Polyurethane Foam Over Sheet Webbing
- Upholstered Covers: Attached w/ Velcro / Removable For Maintenance
- Antimicrobial Moisture Barrier Fully Encapsulates All Foam Areas
- Ganging Straps Standard
- Brushed Aluminum Round Legs Standard / Removable For Maintenance
- Leather Upholstery Is Not Available
- Lifetime Warranty

OPTIONS:

(See Facelift Serpentine Options Pages)

Feather Down & Polyester Pillows Available (See Page 5)

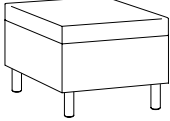
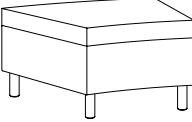
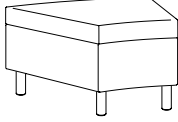
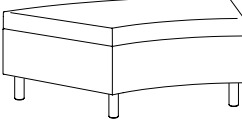
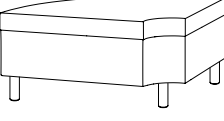
BENCHES		ITEM #:	SPECIFICATIONS GRADES LIST PRICES:													
			Overall: 30"w 22"d 18"h			Arm: n/a			COM: 2 yds.							
			Seat: 30"w 22"d 18"h			Weight: 20 lbs.			COL: n/a							
			COM	COL	1	2	3	4	5	6	7	8	9	10	L1	L2
	1587		813	N/A	867	916	965	1014	1063	1112	1161	1210	1259	1308	N/A	N/A
			<i>Tight Seat / Removable Upholstery / 500 lb. Weight Capacity</i>													
	1587-R		142	N/A	250	307	365	423	481	538	596	654	711	769	N/A	N/A
			<i>Replacement Upholstery Covers</i>													
			Overall: 34"w 30"d 18"h			Arm: n/a			COM: 2.25 yds.							
			Seat: 34"w 19.5"d 18"h			Weight: 40 lbs.			COL: n/a							
			COM	COL	1	2	3	4	5	6	7	8	9	10	L1	L2
	1588		994	N/A	1052	1108	1164	1220	1277	1333	1389	1445	1501	1557	N/A	N/A
			<i>Tight Seat / 60" Radius / Removable Upholstery / 500 lb. Weight Capacity</i>													
	1588-R		157	N/A	280	346	412	478	544	610	676	742	808	874	N/A	N/A
			<i>Replacement Upholstery Covers</i>													
			Overall: 32"w 30"d 18"h			Arm: n/a			COM: 1.75 yds.							
			Seat: 32"w 19.5"d 18"h			Weight: 40 lbs.			COL: n/a							
			COM	COL	1	2	3	4	5	6	7	8	9	10	L1	L2
	1589		943	N/A	976	1018	1060	1102	1144	1186	1228	1270	1313	1355	N/A	N/A
			<i>Tight Seat / 30" Radius / Removable Upholstery / 500 lb. Weight Capacity</i>													
	1589-R		139	N/A	230	280	329	379	428	478	527	577	626	676	N/A	N/A
			<i>Replacement Upholstery Covers</i>													
			Overall: 46.5"w 30"d 18"h			Arm: n/a			COM: 2.5 yds.							
			Seat: 46.5"w 19.5"d 18"h			Weight: 45 lbs.			COL: n/a							
			COM	COL	1	2	3	4	5	6	7	8	9	10	L1	L2
	1590		1322	N/A	1376	1439	1502	1565	1628	1691	1754	1818	1881	1944	N/A	N/A
			<i>Tight Seat / 30" Radius / Removable Upholstery / 500 lb. Weight Capacity</i>													
	1590-R		179	N/A	317	392	466	540	614	689	763	837	911	985	N/A	N/A
			<i>Replacement Upholstery Covers</i>													
			Overall: 51"w 33"d 18"h			Arm: n/a			COM: 2.75 yds.							
			Seat: 51"w 19.5"d 18"h			Weight: 50 lbs.			COL: n/a							
			COM	COL	1	2	3	4	5	6	7	8	9	10	L1	L2
	1591		1441	N/A	1503	1573	1643	1713	1783	1853	1923	1993	2064	2134	N/A	N/A
			<i>Tight Seat / 6" Radius / Removable Upholstery / 500 lb. Weight Capacity</i>													
	1591-R		221	N/A	374	457	539	622	704	787	869	952	1034	1116	N/A	N/A
			<i>Replacement Upholstery Covers</i>													

DESCRIPTION:

- Upholstery Frames: Plywood & Hardwood
- Seat: High Density Polyurethane Foam Over Sheet Webbing
- Upholstered Covers: Attached w/ Velcro / Removable For Maintenance
- Antimicrobial Moisture Barrier Fully Encapsulates All Foam Areas
- Ganging Straps Standard
- Brushed Aluminum Round Legs Standard / Removable For Maintenance
- Leather Upholstery Is Not Available
- Lifetime Warranty

OPTIONS:

(See Facelift Serpentine Options Pages)

Feather Down & Polyester Pillows Available (See Page 5)

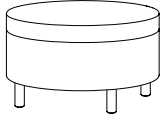
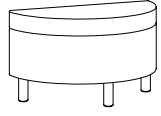
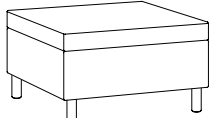
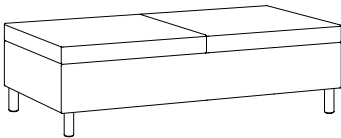
BENCHES		ITEM #:	SPECIFICATIONS GRADES LIST PRICES:												
ROUND BENCH / FULLY UPHOLSTERED 			Overall: 30" Diameter 18"h			Arm: n/a			COM: 2.5 yds.						
			Seat: 30"w 30"d 18"h			Weight: 30 lbs.			COL: n/a						
			COM	COL	1	2	3	4	5	6	7	8	9	10	L1
	1592	1106	N/A	1171	1235	1298	1361	1424	1487	1550	1613	1676	1739	N/A	N/A
		<i>Tight Seat / Removable Upholstery / 500 lb. Weight Capacity</i>													
	1592-R	142	N/A	283	357	431	506	580	654	728	802	877	951	N/A	N/A
		<i>Replacement Upholstery Covers</i>													
HALF-ROUND BENCH / FULLY UPHOLSTERED 			Overall: 30"w 15"d 18"h			Arm: n/a			COM: 1.75 yds.						
			Seat: 30"w 15"d 18"h			Weight: 20 lbs.			COL: n/a						
			COM	COL	1	2	3	4	5	6	7	8	9	10	L1
	1593	881	N/A	917	959	1001	1043	1085	1127	1169	1211	1253	1295	N/A	N/A
		<i>Tight Seat / 60" Radius / Removable Upholstery / 500 lb. Weight Capacity</i>													
	1593-R	139	N/A	230	280	329	378	428	477	527	576	626	675	N/A	N/A
		<i>Replacement Upholstery Covers</i>													
FREESTANDING BENCH / FULLY UPHOLSTERED 			Overall: 30"w 30"d 18"h			Arm: n/a			COM: 1.5 yds.						
			Seat: 30"w 30"d 18"h			Weight: 30 lbs.			COL: n/a						
			COM	COL	1	2	3	4	5	6	7	8	9	10	L1
	1594	1023	N/A	1220	1346	1472	1598	1724	1850	1977	2103	2229	2355	N/A	N/A
		<i>Tight Seat / Removable Upholstery / 500 lb. Weight Capacity</i>													
	1594-R	142	N/A	216	258	299	340	381	422	464	505	546	587	N/A	N/A
		<i>Replacement Upholstery Covers</i>													
FREESTANDING BENCH / FULLY UPHOLSTERED 			Overall: 60"w 30"d 18"h			Arm: n/a			COM: 5.25 yds.						
			Seat: 60"w 30"d 18"h			Weight: 60 lbs.			COL: n/a						
			COM	COL	1	2	3	4	5	6	7	8	9	10	L1
	1595	1761	N/A	1946	2086	2226	2366	2506	2647	2787	2927	3067	3207	N/A	N/A
		<i>Tight Seat / Removable Upholstery / 750 lb. Weight Capacity</i>													
	1595-R	199	N/A	518	683	848	1013	1177	1342	1507	1672	1837	2002	N/A	N/A
		<i>Replacement Upholstery Covers</i>													

DESCRIPTION:

- Upholstery Frames: Plywood & Hardwood
- Upholstered Covers: Attached w/ Velcro / Removable For Maintenance
- Antimicrobial Moisture Barrier Fully Encapsulates All Foam Areas
- Ganging Straps Standard
- Brushed Aluminum Round Legs Standard / Removable For Maintenance
- High Pressure Laminate Top - Self Edge
- Leather Upholstery Is Not Available
- Lifetime Warranty

OPTIONS:

(See Facelift Serpentine Options Pages)

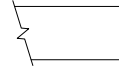

Square Edge Profile Standard

TABLES

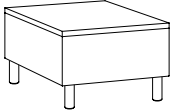
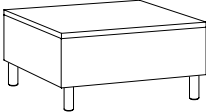
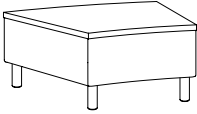
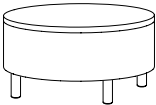
ITEM #:	SPECIFICATIONS GRADES LIST PRICES:													
STRAIGHT TABLE / FREESTANDING OR CONNECTING 	Overall: 30"w 22"d 16"h			Arm: n/a					COM: 1.25 yds.					
	Seat: n/a			Weight: 55 lbs.					COL: n/a					
	COM	COL	1	2	3	4	5	6	7	8	9	10	L1	L2
	152230-L	1057	N/A	1075	1104	1132	1161	1189	1218	1246	1275	1304	1332	N/A
	<i>High Pressure Laminate Face</i>													
152230-C	1544	N/A	1552	1581	1610	1638	1667	1696	1724	1753	1782	1811	N/A	N/A
	<i>Solid Surface Face (Glacier White)</i>													
152230-R	120	N/A	179	212	245	278	311	344	377	410	443	476	N/A	N/A
	<i>Replacement Upholstery Covers</i>													
STRAIGHT TABLE / FREESTANDING OR CONNECTING 	Overall: 30"w 30"d 16"h			Arm: n/a					COM: 1.25 yds.					
	Seat: n/a			Weight: 60 lbs.					COL: n/a					
	COM	COL	1	2	3	4	5	6	7	8	9	10	L1	L2
	153030-L	1149	N/A	1164	1192	1221	1249	1278	1307	1335	1364	1392	1421	N/A
	<i>High Pressure Laminate Face</i>													
153030-C	1956	N/A	1959	1988	2016	2045	2074	2103	2132	2160	2189	2218	N/A	N/A
	<i>Solid Surface Face (Glacier White)</i>													
153030-R	133	N/A	191	224	257	290	323	356	389	422	455	488	N/A	N/A
	<i>Replacement Upholstery Covers</i>													
22.5° TABLE WEDGE / FREESTANDING OR CONNECTING 	Overall: 34"w 30"d 16"h			Arm: n/a					COM: 1.25 yds.					
	Seat: n/a			Weight: 65 lbs.					COL: n/a					
	COM	COL	1	2	3	4	5	6	7	8	9	10	L1	L2
	1522DG60-L	1436	N/A	1440	1469	1497	1526	1554	1583	1611	1640	1668	1697	N/A
	<i>High Pressure Laminate Face / 60" Radius</i>													
1522DG60-C	2284	N/A	2291	2320	2349	2378	2407	2436	2465	2494	2523	2552	N/A	N/A
	<i>Solid Surface Face (Glacier White) / 60" Radius</i>													
1522DG60-R	140	N/A	199	232	265	298	331	364	397	430	463	496	N/A	N/A
	<i>Replacement Upholstery Covers</i>													
ROUND COFFEE TABLE / FREESTANDING 	Overall: 30" Diameter 16"h			Arm: n/a					COM: 1.25 yds.					
	Seat: 18"h			Weight: 55 lbs.					COL: n/a					
	COM	COL	1	2	3	4	5	6	7	8	9	10	L1	L2
	1530D16-L	1255	N/A	1266	1294	1323	1351	1380	1408	1437	1465	1494	1523	N/A
	<i>High Pressure Laminate Face / Round</i>													
1530D16-C	2186	N/A	2191	2220	2249	2277	2306	2335	2364	2393	2422	2451	N/A	N/A
	<i>Solid Surface Face (Glacier White) / Round</i>													
1530D16-R	141	N/A	199	232	265	298	331	364	397	430	463	496	N/A	N/A
	<i>Replacement Upholstery Covers</i>													

DESCRIPTION:

- Upholstery Frames: Plywood & Hardwood
- Upholstered Covers: Attached w/ Velcro / Removable For Maintenance
- Antimicrobial Moisture Barrier Fully Encapsulates All Foam Areas
- Ganging Straps Standard
- Brushed Aluminum Round Legs Standard / Removable For Maintenance
- High Pressure Laminate Top - Self Edge
- Leather Upholstery Is Not Available
- Lifetime Warranty

OPTIONS:

(See Facelift Serpentine Options Pages)

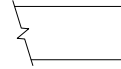



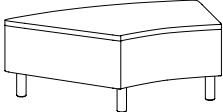
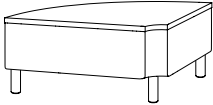
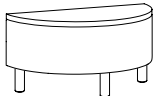

Square Edge Profile Standard

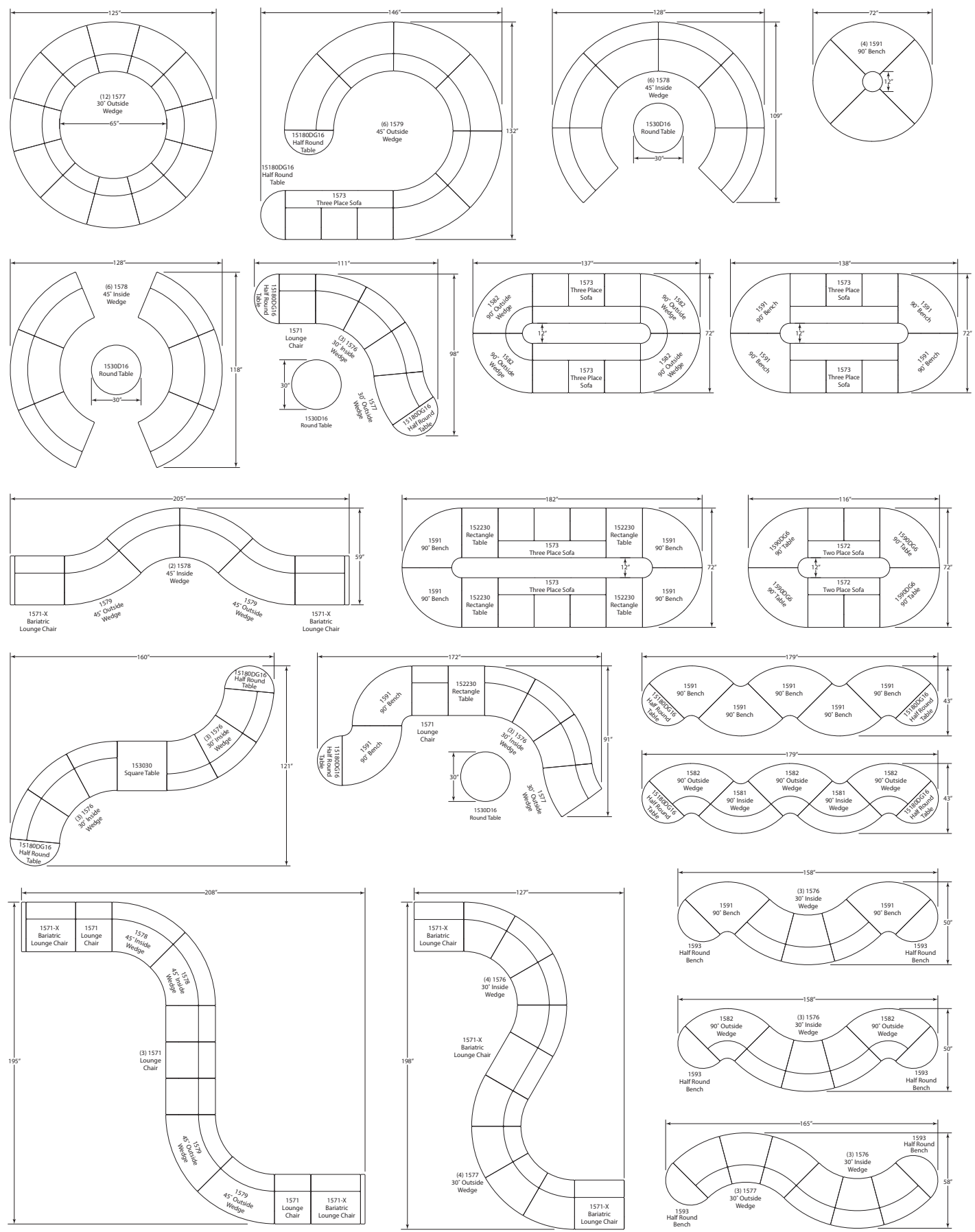

TABLES

ITEM #:		SPECIFICATIONS GRADES LIST PRICES:													
<p>STRAIGHT TABLE / FREESTANDING OR CONNECTING</p> 		Overall: 32"w 30"d 16"h			Arm: n/a			COM: 1.25 yds.							
		Seat: n/a			Weight: 60 lbs.			COL: n/a							
		COM	COL	1	2	3	4	5	6	7	8	9	10	L1	L2
	1530DG30-L	1281	N/A	1291	1319	1348	1376	1405	1433	1462	1491	1519	1548	N/A	N/A
	<i>High Pressure Laminate Face / 30" Radius</i>														
	1530DG30-C	2266	N/A	2268	2297	2326	2355	2384	2413	2442	2471	2500	2529	N/A	N/A
	<i>Solid Surface Face (Glacier White) / 30" Radius</i>														
	1530DG30-R	128	N/A	187	220	253	286	319	352	385	418	451	484	N/A	N/A
	<i>Replacement Upholstery Covers</i>														
<p>STRAIGHT TABLE / FREESTANDING OR CONNECTING</p> 		Overall: 46.5"w 30"d 16"h			Arm: n/a			COM: 1.25 yds.							
		Seat: n/a			Weight: 95 lbs.			COL: n/a							
		COM	COL	1	2	3	4	5	6	7	8	9	10	L1	L2
	1545DG30-L	1832	N/A	1835	1864	1893	1921	1950	1979	2008	2036	2065	2094	N/A	N/A
	<i>High Pressure Laminate Face / 30" Radius</i>														
	1545DG30-C	3647	N/A	3650	3679	3709	3738	3767	3796	3826	3855	3884	3913	N/A	N/A
	<i>Solid Surface Face (Glacier White) / 30" Radius</i>														
	1545DG30-R	186	N/A	241	274	307	340	373	406	439	472	505	538	N/A	N/A
	<i>Replacement Upholstery Covers</i>														
<p>22.5° TABLE WEDGE / FREESTANDING OR CONNECTING</p> 		Overall: 51"w 32"d 16"h			Arm: n/a			COM: 2 yds.							
		Seat: n/a			Weight: 110 lbs.			COL: n/a							
		COM	COL	1	2	3	4	5	6	7	8	9	10	L1	L2
	1590DG6-L	1825	N/A	1833	1883	1932	1981	2031	2080	2129	2179	2228	2277	N/A	N/A
	<i>High Pressure Laminate Face / 6" Radius</i>														
	1590DG6-C	3254	N/A	3258	3308	3358	3409	3459	3510	3560	3610	3661	3711	N/A	N/A
	<i>Solid Surface Face (Glacier White) / 6" Radius</i>														
	1590DG6-R	208	N/A	312	370	428	485	543	601	659	716	774	832	N/A	N/A
	<i>Replacement Upholstery Covers</i>														
<p>HALF ROUND COFFEE TABLE / FREESTANDING</p> 		Overall: 30"w 15"d 16"h			Arm: n/a			COM: 1 yd.							
		Seat: n/a			Weight: 40 lbs.			COL: n/a							
		COM	COL	1	2	3	4	5	6	7	8	9	10	L1	L2
	15180DG16-L	1113	N/A	1114	1136	1157	1178	1200	1221	1243	1264	1286	1307	N/A	N/A
	<i>High Pressure Laminate Face</i>														
	15180DG16-C	1510	N/A	1511	1532	1554	1576	1597	1619	1641	1662	1684	1705	N/A	N/A
	<i>Solid Surface Face (Glacier White)</i>														
	15180DG16-R	127	N/A	219	268	318	367	417	466	516	565	615	664	N/A	N/A
	<i>Replacement Upholstery Covers</i>														





Configuration Examples



ARM CAPS	OPTION #:	SPECIFICATIONS LIST PRICES AVAILABILITY:														
<p>FULLY UPHOLSTERED ARM</p> 		<p>Overall: 2.5"w 30.5"d 18"h COM: 1.5 yds.</p>														
		<table border="1"> <thead> <tr> <th>COM</th> <th>COL</th> <th>1</th> <th>2</th> <th>3</th> <th>4</th> <th>5</th> <th>6</th> <th>7</th> <th>8</th> <th>9</th> <th>10</th> <th>L1</th> <th>L2</th> </tr> </thead> </table>	COM	COL	1	2	3	4	5	6	7	8	9	10	L1	L2
	COM	COL	1	2	3	4	5	6	7	8	9	10	L1	L2		
	A1	<table border="1"> <tbody> <tr> <td>222</td> <td>N/A</td> <td>282</td> <td>311</td> <td>341</td> <td>371</td> <td>400</td> <td>430</td> <td>460</td> <td>489</td> <td>519</td> <td>549</td> <td>N/A</td> <td>N/A</td> </tr> </tbody> </table> <p>Fully Upholstered Arm (Specify Fabric)</p>	222	N/A	282	311	341	371	400	430	460	489	519	549	N/A	N/A
222	N/A	282	311	341	371	400	430	460	489	519	549	N/A	N/A			
A1-R	<table border="1"> <tbody> <tr> <td>77</td> <td>N/A</td> <td>155</td> <td>197</td> <td>237</td> <td>279</td> <td>321</td> <td>362</td> <td>403</td> <td>446</td> <td>485</td> <td>529</td> <td>N/A</td> <td>N/A</td> </tr> </tbody> </table> <p>Replacement Upholstery Covers</p> <p>Available: Facelift Serpentine Lounge Units</p>	77	N/A	155	197	237	279	321	362	403	446	485	529	N/A	N/A	
77	N/A	155	197	237	279	321	362	403	446	485	529	N/A	N/A			
<p>UPHOLSTERED ARM / EXPOSED WOOD ARM CAP</p> 		<p>Overall: 2.5"w 30.5"d 18.5"h COM: 1.5 yds.</p>														
		<table border="1"> <thead> <tr> <th>COM</th> <th>COL</th> <th>1</th> <th>2</th> <th>3</th> <th>4</th> <th>5</th> <th>6</th> <th>7</th> <th>8</th> <th>9</th> <th>10</th> <th>L1</th> <th>L2</th> </tr> </thead> </table>	COM	COL	1	2	3	4	5	6	7	8	9	10	L1	L2
	COM	COL	1	2	3	4	5	6	7	8	9	10	L1	L2		
	A1W	<table border="1"> <tbody> <tr> <td>289</td> <td>N/A</td> <td>366</td> <td>405</td> <td>443</td> <td>482</td> <td>520</td> <td>559</td> <td>597</td> <td>636</td> <td>675</td> <td>713</td> <td>N/A</td> <td>N/A</td> </tr> </tbody> </table> <p>Upholstered Arm / Exposed Wood Arm Cap (Specify Fabric & Finish)</p>	289	N/A	366	405	443	482	520	559	597	636	675	713	N/A	N/A
289	N/A	366	405	443	482	520	559	597	636	675	713	N/A	N/A			
A1W-R	<table border="1"> <tbody> <tr> <td>77</td> <td>N/A</td> <td>155</td> <td>197</td> <td>237</td> <td>279</td> <td>321</td> <td>362</td> <td>403</td> <td>446</td> <td>485</td> <td>529</td> <td>N/A</td> <td>N/A</td> </tr> </tbody> </table> <p>Replacement Upholstery Covers</p> <p>Available: Facelift Serpentine Lounge Units</p>	77	N/A	155	197	237	279	321	362	403	446	485	529	N/A	N/A	
77	N/A	155	197	237	279	321	362	403	446	485	529	N/A	N/A			
<p>UPHOLSTERED ARM / CONTRASTING FABRIC / VINYL ARM CAP</p> 		<p>Overall: 2.5"w 30.5"d 18"h COM: 1.5 yds.</p>														
		<table border="1"> <thead> <tr> <th>COM</th> <th>COL</th> <th>1</th> <th>2</th> <th>3</th> <th>4</th> <th>5</th> <th>6</th> <th>7</th> <th>8</th> <th>9</th> <th>10</th> <th>L1</th> <th>L2</th> </tr> </thead> </table>	COM	COL	1	2	3	4	5	6	7	8	9	10	L1	L2
	COM	COL	1	2	3	4	5	6	7	8	9	10	L1	L2		
	A1U	<table border="1"> <tbody> <tr> <td>278</td> <td>N/A</td> <td>352</td> <td>389</td> <td>426</td> <td>463</td> <td>500</td> <td>537</td> <td>575</td> <td>612</td> <td>649</td> <td>686</td> <td>N/A</td> <td>N/A</td> </tr> </tbody> </table> <p>Upholstered Arm / Contrasting Fabric / Vinyl Arm Cap (Specify Fabric & Vinyl)</p>	278	N/A	352	389	426	463	500	537	575	612	649	686	N/A	N/A
278	N/A	352	389	426	463	500	537	575	612	649	686	N/A	N/A			
A1U-R	<table border="1"> <tbody> <tr> <td>77</td> <td>N/A</td> <td>155</td> <td>197</td> <td>237</td> <td>279</td> <td>321</td> <td>362</td> <td>403</td> <td>446</td> <td>485</td> <td>529</td> <td>N/A</td> <td>N/A</td> </tr> </tbody> </table> <p>Replacement Upholstery Covers</p> <p>Available: Facelift Serpentine Lounge Units</p>	77	N/A	155	197	237	279	321	362	403	446	485	529	N/A	N/A	
77	N/A	155	197	237	279	321	362	403	446	485	529	N/A	N/A			
<p>INTERIM UPHOLSTERED ARM / EXPOSED WOOD ARM CAP</p> 		<p>Overall: 3"w 13.5"d 6"h COM: .75 yds.</p>														
		<table border="1"> <thead> <tr> <th>COM</th> <th>COL</th> <th>1</th> <th>2</th> <th>3</th> <th>4</th> <th>5</th> <th>6</th> <th>7</th> <th>8</th> <th>9</th> <th>10</th> <th>L1</th> <th>L2</th> </tr> </thead> </table>	COM	COL	1	2	3	4	5	6	7	8	9	10	L1	L2
	COM	COL	1	2	3	4	5	6	7	8	9	10	L1	L2		
	A2W	<table border="1"> <tbody> <tr> <td>289</td> <td>N/A</td> <td>366</td> <td>405</td> <td>443</td> <td>482</td> <td>520</td> <td>559</td> <td>597</td> <td>636</td> <td>675</td> <td>713</td> <td>N/A</td> <td>N/A</td> </tr> </tbody> </table> <p>Interim Upholstered Arm / Exposed Wood Arm Cap (Specify Fabric & Finish)</p>	289	N/A	366	405	443	482	520	559	597	636	675	713	N/A	N/A
289	N/A	366	405	443	482	520	559	597	636	675	713	N/A	N/A			
A2W-R	<table border="1"> <tbody> <tr> <td>67</td> <td>N/A</td> <td>135</td> <td>171</td> <td>206</td> <td>243</td> <td>279</td> <td>315</td> <td>350</td> <td>388</td> <td>422</td> <td>460</td> <td>N/A</td> <td>N/A</td> </tr> </tbody> </table> <p>Replacement Upholstery Covers</p> <p>Available: Facelift Serpentine Lounge & Wedge Units</p>	67	N/A	135	171	206	243	279	315	350	388	422	460	N/A	N/A	
67	N/A	135	171	206	243	279	315	350	388	422	460	N/A	N/A			

ARM CAPS / TABLET ARMS	OPTION #:	SPECIFICATIONS LIST PRICES AVAILABILITY:													
<p>UPHOLSTERED / URETHANE TASK ARM</p> 	<p><i>Overall: 3.25"w 9.5"d 18"h</i> <i>COM: .75 yds.</i></p> <table border="1"> <thead> <tr> <th>COM</th> <th>COL</th> <th>1</th> <th>2</th> <th>3</th> <th>4</th> <th>5</th> <th>6</th> <th>7</th> <th>8</th> <th>9</th> <th>10</th> <th>L1</th> <th>L2</th> </tr> </thead> </table> <p>A5 \$281 <i>Outside Urethane Task Arm (Black)</i></p> <p>A6 \$219 <i>Inside Urethane Task Arm (Black)</i></p> <p>Available: Facelift Serpentine Lounge & Wedge Units</p>	COM	COL	1	2	3	4	5	6	7	8	9	10	L1	L2
COM	COL	1	2	3	4	5	6	7	8	9	10	L1	L2		
<p>POLE SWIVEL TABLET ARM</p> 	<p><i>Overall: 14.25" Diameter 22.5"h</i></p> <p>PT \$556 (Pole & Black Laminate Tablet)</p> <p>ST-1 \$603 (Pole & Veneer Tablet)</p> <p>ST-2 \$698 (Pole & White Solid Surface Tablet)</p> <p>Available: Facelift Serpentine Lounge & Wedge End Units</p>														

LEGS / CASTERS / PUSH BAR	OPTION #:	SPECIFICATIONS LIST PRICES AVAILABILITY:
<p>BRUSHED ALUMINUM ROUND LEGS</p> 	<p>Overall: 2" Diameter 5"h</p> <hr/> <p>ARL Standard Leg On All Serpentine Units - No Charge (Brushed Aluminum Finish)</p> <p><i>Available: Facelift Serpentine Collection</i></p>	
<p>WOOD ROUND LEGS</p> 	<p>Overall: 1.75" Diameter 5"h</p> <hr/> <p>WR Deduct \$80 (Set Of 4) Wood Round Leg (Specify Finish)</p> <p><i>Available: Facelift Serpentine Collection</i></p>	
<p>CASTERS</p> 	<p>Overall: 3"w 4"d 4"h</p> <hr/> <p>CS \$120 (Set Of 2) Dual Wheel / Non-Locking Casters (Black Finish)</p> <p>CL \$140 (Set Of 2) Dual Wheel / Locking Casters (Black Finish)</p> <p><i>Available: Facelift Serpentine Lounge Units</i></p>	
<p>PUSH BAR</p> 	<p>Overall: 18.5"w 3.5"d 1"h</p> <hr/> <p>PB \$267 (Black Finish)</p> <p><i>Available: Facelift Serpentine Lounge Units</i></p>	

POWER / COVERS	OPTION #:	SPECIFICATIONS LIST PRICES AVAILABILITY:
<p>POWER / DATA MODULE</p>  <p>PM1 Power / Data Module</p>  <p>PM2 Power Module</p>  <p>USB-1 Dual Charging USB</p>	<p>PM1</p> <p>PM2</p> <p>USB-1</p>	<p>PM1 Overall: 5.25"w 1.25"d 4.25"h PM2 Overall: 2"w 2"d .125"h USB-1 Overall: 2"w 2"d .125"h</p> <p>\$859 Power/Data Module (1-Power / 1-USB 2 Port Simplex Charger Standard) <i>Vertical / Horizontal Mount Power Module. Price Varies By Socket. Contact Customer Service For Quote. (Additional Colors Available)</i></p> <p>\$238 Power Module (1-Power) <i>Spill-Proof Technology / Multiple Finish Options / Storm Color Standard (Specify Left or Right Facing)</i></p> <p>\$238 Dual Charging USB (2 Port Simplex Charger Standard) <i>Spill-Proof Technology / 2 Amps Per Port / Multiple Finish Options / Storm Color Standard (Specify Left or Right Facing)</i></p> <p>Available: <i>Facelift Serpentine Collection</i></p>
<p>CONTRASTING COVERS</p> 	<p>CC</p>	<p>\$129</p> <p><i>NOTE: If Two Or More Upholsteries Or Leathers Are Used On Any Piece Of Furniture, Then A Contrast Charge Will Apply Per Order. When Using Trinity Upholstery, The Higher Priced Upholstery Grade Will Be Used In Pricing, Unless It's Trinity Leather With Fabric Contrast Welt, Or COM With Trinity Contrast Welt, Then Contact Customer Service For Pricing.</i></p> <p>Available: <i>Facelift Serpentine Collection</i></p>

Facelift Tuxedo

LOUNGE SLEEPER

Effective: March 1, 2025

T R I N I T Y

Date:

Page:

Modification:

Description:

DESCRIPTION:

- Upholstery Frames: Plywood & Hardwood
- Seat: High Density Polyurethane Foam Over Sheet Webbing
- Back: High Density Poly-Dacron Foam Over Hardwood Plywood
- Upholstered Covers: Attached w/ Velcro / Removable For Maintenance (Seat Only)
- Antimicrobial Moisture Barrier Fully Encapsulates Seat Area
- Removable Bolster Pillows (2)
- Double Needle Stitching Standard
- Wood Legs Front / Casters Rear
- Leather Upholstery Not Available / Storage Drawer Not Available
- Lifetime Warranty

OPTIONS:

- ASL Aluminum Square Legs (Set Of 4).....\$382
- ARL Brushed Aluminum Round Legs (Set Of 4).....\$346
- SLC Swivel Locking Casters (Set Of 4).....\$292
- Surface Caps..... SEE OPTIONS
- Pole Swivel Tablet Arm..... SEE OPTIONS
- PM1 Power/Data Module (1-Power / 1-USB 2 Port Simplex Charger)\$859
- USB-1 USB In Back (2 Ports Available - Specify Left or Right Facing).....\$238
- PM2 Power Module (1-Power - Specify Left or Right Facing).....\$238
- Feather Down & Polyester Pillows Available (See Page 5)

LOUNGE SLEEPER

ITEM #:

SPECIFICATIONS | GRADES | LIST PRICES:

SLEEPER / FULLY UPHOLSTERED

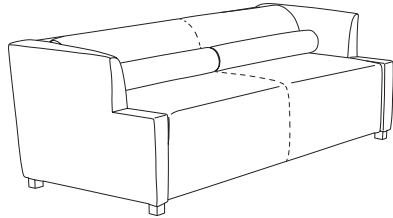

Overall: 87" w 36" d 28" h **Arm:** 28" h **COM:** 10.25 yds.
Seat: 76" w 30" d 18" h **Weight:** 185 lbs. **COL:** n/a

COM	COL	1	2	3	4	5	6	7	8	9	10	L1	L2
4165	N/A	4431	4678	4925	5172	5419	5666	5913	6160	6406	6653	N/A	N/A

Tight Seat & Back / Removable Upholstery (Seat Only) / 1000 lb. Weight Capacity

1603

1603-R

Call For Pricing
 Replacement Seat Upholstery









Our Tuxedo Lounge reveals a fully suspended adult sleep surface by simply raising the back cushion; a transformation requiring no additional space in the patient room.



Closed Sitting Position:



Open Sleep Position:

LEGS / CASTERS / SURFACE CAPS / TABLET ARMS / POWER / COVERS	OPTION #:	SPECIFICATIONS LIST PRICES AVAILABILITY:
ALUMINUM SQUARE LEGS		Overall: 2.25"w 2.25"d 2.25"h
	ASL	\$382 (Set Of 4) <i>(Brushed Finish)</i> Available: <i>Facelift Tuxedo Collection</i>
BRUSHED ALUMINUM ROUND LEGS		Overall: 2" Diameter 5"h
	ARL	\$346 (Set Of 4) <i>(Brushed Aluminum Finish)</i> Available: <i>Facelift Tuxedo Collection</i>
SWIVEL LOCKING CASTERS		Overall: 3"h
	SLC	\$292 (Set Of 4) <i>(Swivel Locking Plastic Casters)</i> NOTE: Casters Are Recessed Under The Sofa Unit And Will Not Be Visible Available: <i>Facelift Tuxedo Collection</i>
SURFACE CAPS		Back Cap Size: 82"w 7"d .50"h Arm Cap Size: 5"w 10"d .50"h
	CSC-1 CSC-2	\$570 (Back & Arms) <i>Solid Surface (White)</i> \$197 (Arms Only) <i>Solid Surface (White)</i> Available: <i>Facelift Tuxedo Collection</i>
Surface Caps For Back & Arms Shown In White Solid Surface		
POLE SWIVEL TABLET ARM		Overall: 14.25" Diameter 22.5"h
	PT ST-1 ST-2	\$556 (Pole & Black Laminate Tablet) \$603 (Pole & Veneer Tablet) \$698 (Pole & White Solid Surface Tablet) Available: <i>Facelift Serpentine Lounge & Wedge End Units</i>
POWER / DATA MODULE		PM1 Overall: 5.25"w 1.25"d 4.25"h PM2 Overall: 2"w 2"d .125"h USB-1 Overall: 2"w 2"d .125"h
		PM1
		PM2
USB-1 Dual Charging USB	PM1 Power / Data Module	USB-1
	PM2 Power Module	
		\$859 Power/Data Module (1-Power / 1-USB 2 Port Simplex Charger Standard) <i>Vertical / Horizontal Mount Power Module. Price Varies By Socket. Contact Customer Service For Quote. (Additional Colors Available)</i> \$238 Power Module (1-Power) <i>Spill-Proof Technology / Multiple Finish Options / Storm Color Standard (Specify Left or Right Facing)</i> \$238 Dual Charging USB (2 Port Simplex Charger Standard) <i>Spill-Proof Technology / 2 Amps Per Port / Multiple Finish Options / Storm Color Standard (Specify Left or Right Facing)</i> Available: <i>Facelift Tuxedo Collection</i>
CONTRASTING COVERS		Overall: N/A
	CC	\$129 <i>NOTE: If Two Or More Upholsteries Or Leathers Are Used On Any Piece Of Furniture, Then A Contrast Charge Will Apply Per Order. When Using Trinity Upholstery, The Higher Priced Upholstery Grade Will Be Used In Pricing, Unless It's Trinity Leather With Fabric Contrast Welt, Or COM With Trinity Contrast Welt, Then Contact Customer Service For Pricing.</i> Available: <i>Facelift Tuxedo Collection</i>

Facelift Prime

LOUNGE

Effective: March 1, 2025

T R I N I T Y

Date:

Page:

Modification:

Description:

DESCRIPTION:

- Upholstery Frames: Steel, Plywood & Hardwood
- Seat: High Density Polyurethane Foam Over Strap Webbing
- Back: High Density Polyurethane Foam Over Sinuous Wire Springs
- Upholstered Covers: Attached w/ Velcro / Removable For Maintenance
- Exposed Wood Legs: Solid Hardwood / Removable For Maintenance
- Antimicrobial Moisture Barrier Fully Encapsulates All Foam Areas
- Leather Upholstery Not Available
- Lifetime Warranty

OPTIONS:

- WAC-1 Solid Wood Arm Caps (Set Of 2) \$155
- UAC-1 Black Urethane Arm Caps (Set Of 2) \$206
- ARL Brushed Aluminum Round Legs (Set Of 4) \$346
- PM1 Power/Data Module (1-Power / 1-USB 2 Port Simplex Charger) \$859
(Additional Power/Data Modules Available - See Prime Lounge Options)

Feather Down & Polyester Pillows Available (See Page 5)
Specify Exposed Wood Finish (See Page 6)
Tablet Arm / Cup Holder Options (See Facelift Prime Lounge Options Pages)
Biscuit Tufting Available Upon Request (Contact Customer Service For Pricing)

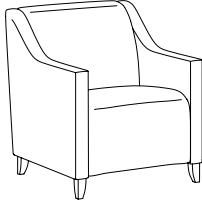
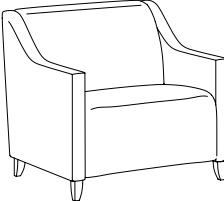
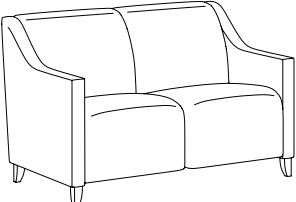
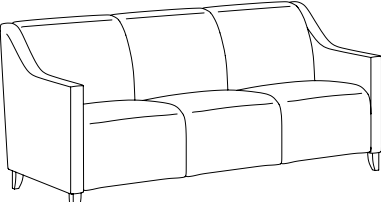
LOUNGE		ITEM #:	SPECIFICATIONS GRADES LIST PRICES:													
	LOUNGE CHAIR / FULLY UPHOLSTERED		Overall: 28"w 32.5"d 34"h			Arm: 25"h			COM: 5 yds.							
			Seat: 23"w 20.5"d 18"h			Weight: 90 lbs.			COL: n/a							
			COM	COL	1	2	3	4	5	6	7	8	9	10	L1	L2
	1701	1564	N/A	1753	1890	2027	2164	2301	2439	2576	2713	2850	2987	N/A	N/A	
		<i>Tight Seat & Back / Removable Upholstery / 500 lb. Weight Capacity</i>														
	1701-R	280	N/A	565	715	866	1016	1166	1316	1466	1616	1767	1917	N/A	N/A	
		<i>Replacement Upholstery Covers</i>														
	BARIATRIC LOUNGE CHAIR / FULLY UPHOLSTERED		Overall: 34"w 32.5"d 34"h			Arm: 25"h			COM: 5.5 yds.							
			Seat: 29"w 20.5"d 18"h			Weight: 100 lbs.			COL: n/a							
			COM	COL	1	2	3	4	5	6	7	8	9	10	L1	L2
	1701-X	1955	N/A	2151	2303	2454	2606	2758	2909	3061	3212	3364	3515	N/A	N/A	
		<i>Tight Seat & Back / Removable Upholstery / 1000 lb. Weight Capacity</i>														
	1701-XR	280	N/A	597	763	929	1095	1261	1427	1593	1759	1925	2091	N/A	N/A	
		<i>Replacement Upholstery Covers</i>														
	TWO PLACE SOFA / FULLY UPHOLSTERED		Overall: 51"w 32.5"d 34"h			Arm: 25"h			COM: 7.25 yds.							
			Seat: 46"w 20.5"d 18"h			Weight: 155 lbs.			COL: n/a							
			COM	COL	1	2	3	4	5	6	7	8	9	10	L1	L2
	1702	2400	N/A	2674	2876	3078	3280	3482	3684	3886	4088	4290	4492	N/A	N/A	
		<i>Tight Seat & Back / Removable Upholstery / 1000 lb. Weight Capacity</i>														
	1702-R	412	N/A	832	1054	1275	1496	1717	1939	2160	2381	2603	2824	N/A	N/A	
		<i>Replacement Upholstery Covers</i>														
	THREE PLACE SOFA / FULLY UPHOLSTERED		Overall: 74"w 32.5"d 34"h			Arm: 25"h			COM: 9.75 yds.							
			Seat: 69"w 20.5"d 18"h			Weight: 215 lbs.			COL: n/a							
			COM	COL	1	2	3	4	5	6	7	8	9	10	L1	L2
	1703	3242	N/A	3614	3888	4162	4436	4710	4985	5259	5533	5807	6081	N/A	N/A	
		<i>Tight Seat & Back / Removable Upholstery / 1000 lb. Weight Capacity</i>														
	1703-R	520	N/A	1092	1393	1693	1993	2294	2594	2894	3195	3495	3795	N/A	N/A	
		<i>Replacement Upholstery Covers</i>														

DESCRIPTION:



- Upholstery Frames: Steel, Plywood & Hardwood
- Seat: High Density Polyurethane Foam Over Strap Webbing
- Back: High Density Polyurethane Foam Over Sinuous Wire Springs
- Upholstered Covers: Attached w/ Velcro / Removable For Maintenance
- Exposed Wood Legs: Solid Hardwood / Removable For Maintenance
- Antimicrobial Moisture Barrier Fully Encapsulates All Foam Areas
- Leather Upholstery Not Available
- Lifetime Warranty

OPTIONS:



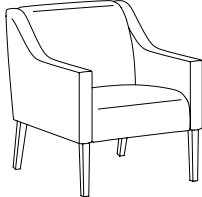
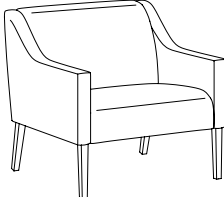
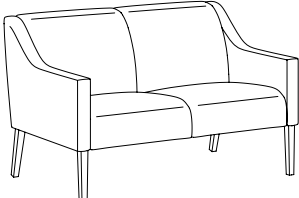
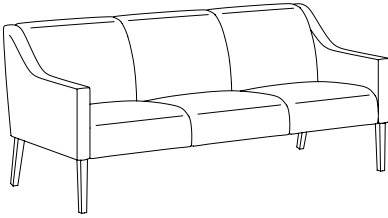

- WAC-1 Solid Wood Arm Caps (Set Of 2)\$155
- UAC-1 Black Urethane Arm Caps (Set Of 2).....\$206
- PM1 Power/Data Module (1-Power / 1-USB 2 Port Simplex Charger)\$859
(Additional Power/Data Modules Available - See Prime Lounge Options)

Feather Down & Polyester Pillows Available (See Page 5)
 Specify Exposed Wood Finish (See Page 6)
 Tablet Arm / Cup Holder Options (See Facelift Prime Lounge Options Pages)
 Biscuit Tufting Available Upon Request (Contact Customer Service For Pricing)

LOUNGE		ITEM #:	SPECIFICATIONS GRADES LIST PRICES:													
	LOUNGE CHAIR / FULLY UPHOLSTERED		Overall: 28"w 32.5"d 34"h			Arm: 25"h			COM: 4.75 yds.							
			Seat: 23"w 20.5"d 18"h			Weight: 80 lbs.			COL: n/a							
			COM	COL	1	2	3	4	5	6	7	8	9	10	L1	L2
	1711	1662	N/A	1831	1961	2091	2221	2351	2480	2610	2740	2870	3000	N/A	N/A	
		<i>Tight Seat & Back / Removable Upholstery / 350 lb. Weight Capacity</i>														
	1711-R	262	N/A	532	674	817	959	1101	1243	1386	1528	1670	1813	N/A	N/A	
		<i>Replacement Upholstery Covers</i>														
	BARIATRIC LOUNGE CHAIR / FULLY UPHOLSTERED		Overall: 34"w 32.5"d 34"h			Arm: 25"h			COM: 5.25 yds.							
			Seat: 29"w 20.5"d 18"h			Weight: 90 lbs.			COL: n/a							
			COM	COL	1	2	3	4	5	6	7	8	9	10	L1	L2
	1711-X	1931	N/A	2114	2258	2403	2547	2691	2835	2980	3124	3268	3413	N/A	N/A	
		<i>Tight Seat & Back / Removable Upholstery / 500 lb. Weight Capacity</i>														
	1711-XR	262	N/A	564	722	880	1038	1196	1354	1512	1670	1828	1986	N/A	N/A	
		<i>Replacement Upholstery Covers</i>														
	TWO PLACE SOFA / FULLY UPHOLSTERED		Overall: 51"w 32.5"d 34"h			Arm: 25"h			COM: 6.5 yds.							
			Seat: 46"w 20.5"d 18"h			Weight: 140 lbs.			COL: n/a							
			COM	COL	1	2	3	4	5	6	7	8	9	10	L1	L2
	1712	2559	N/A	2780	2961	3141	3322	3502	3682	3863	4043	4224	4404	N/A	N/A	
		<i>Tight Seat & Back / Removable Upholstery / 750 lb. Weight Capacity</i>														
	1712-R	388	N/A	762	959	1157	1355	1552	1750	1947	2145	2343	2540	N/A	N/A	
		<i>Replacement Upholstery Covers</i>														
	THREE PLACE SOFA / FULLY UPHOLSTERED		Overall: 74"w 32.5"d 34"h			Arm: 25"h			COM: 8.5 yds.							
			Seat: 69"w 20.5"d 18"h			Weight: 200 lbs.			COL: n/a							
			COM	COL	1	2	3	4	5	6	7	8	9	10	L1	L2
	1713	3352	N/A	3645	3883	4122	4360	4598	4836	5074	5312	5550	5788	N/A	N/A	
		<i>Tight Seat & Back / Removable Upholstery / 750 lb. Weight Capacity</i>														
	1713-R	490	N/A	985	1245	1506	1767	2028	2289	2550	2810	3071	3332	N/A	N/A	
		<i>Replacement Upholstery Covers</i>														

ARM CAPS / LEGS	OPTION #:	SPECIFICATIONS LIST PRICES AVAILABILITY:
<p>SOLID WOOD ARM CAPS</p> 	<p>WAC-1</p> <p>\$155 (Set Of 2) <i>(Specify Finish)</i></p> <p>Available: <i>Facelift Prime Collection</i></p>	<p>Overall: 3.25"w 17.5"d 1.25"h</p>
<p>URETHANE ARM CAPS</p> 	<p>UAC-1</p> <p>\$206 (Set Of 2) <i>(Black Urethane)</i></p> <p>Available: <i>Facelift Prime Collection</i></p>	<p>Overall: 3.25"w 17.5"d 1.25"h</p>
<p>BRUSHED ALUMINUM ROUND LEGS</p> 	<p>ARL</p> <p>\$346 (Set Of 4) <i>(Brushed Aluminum Finish)</i></p> <p>Available: <i>Facelift Prime Lounge Collection (1701, 1701-X, 1702, 1703)</i></p>	<p>Overall: 2" Diameter 5"h</p>

TABLET ARMS / POWER / COVERS	OPTION #:	SPECIFICATIONS LIST PRICES AVAILABILITY:
TABLET ARMS / CUP HOLDER		
 <p>Laminate Tablet Arm Shown w/ Cup Holder</p>		<p>Overall: 14" Diameter .75"h</p>
 <p>Veneer Tablet Arm Shown w/ Cup Holder</p>	<p>TA-L</p>	<p>\$509 Tablet Arm With 360° Rotation - High Pressure Laminate. (Specify Laminate / Specify Left Or Right Facing Arm Location)</p>
	<p>TA-V</p>	<p>\$580 Tablet Arm With 360° Rotation - Sunburst Cherry Veneer. (Specify Finish / Specify Left Or Right Facing Arm Location)</p>
	<p>TA-C</p>	<p>\$698 Tablet Arm With 360° Rotation - White Solid Surface. (Available In White Only / Specify Left Or Right Facing Arm Location)</p>
 <p>Solid Surface Tablet Arm Shown w/ Cup Holder</p>	<p>CH-1</p>	<p>\$129 Black Plastic Cup Holder (Only Available If Used With Tablet Arm)</p>
	<p>CH-2</p>	<p>\$186 Spun Aluminum Cup Holder (Only Available If Used With Tablet Arm)</p>
<p>Available: Facelift Prime Collection</p>		
FOLD DOWN TABLET ARM		
<p>Overall: 14" Diameter .75"h</p>		
	<p>FDTA-L</p>	<p>\$1065 Tablet Arm With 360° Rotation - High Pressure Laminate. (Specify Laminate / Specify Left Or Right Facing Arm Location)</p>
	<p>FDTA-V</p>	<p>\$1136 Tablet Arm With 360° Rotation - Sunburst Cherry Veneer. (Specify Finish / Specify Left Or Right Facing Arm Location)</p>
	<p>FDTA-C</p>	<p>\$1278 Tablet Arm With 360° Rotation - White Solid Surface. (Available In White Only / Specify Left Or Right Facing Arm Location)</p>
<p>Available: Facelift Prime Collection</p>		
DOUBLE ARTICULATING / SWIVEL TABLET ARM		
<p>Overall: 14" Diameter .75"h</p>		
	<p>ATA-L</p>	<p>\$983 Tablet Arm With 360° Rotation - High Pressure Laminate. (Specify Laminate / Specify Left Or Right Facing Arm Location)</p>
 <p>ATA-L Double Articulating / Swivel Tablet Arm</p>	<p>ATA-V</p>	<p>\$1055 Tablet Arm With 360° Rotation - Sunburst Cherry Veneer. (Specify Finish / Specify Left Or Right Facing Arm Location)</p>
	<p>ATA-C</p>	<p>\$1173 Tablet Arm With 360° Rotation - White Solid Surface. (Available In White Only / Specify Left Or Right Facing Arm Location)</p>
 <p>ATA-L w/ CH-1 Black Plastic Cup Holder</p>	<p>CH-1</p>	<p>\$129 Black Plastic Cup Holder (Only Available If Used With Tablet Arm)</p>
	<p>CH-2</p>	<p>\$186 Spun Aluminum Cup Holder (Only Available If Used With Tablet Arm)</p>
<p>Available: Facelift Prime Collection</p>		

TABLET ARMS / POWER / COVERS	OPTION #:	SPECIFICATIONS LIST PRICES AVAILABILITY:
POWER / DATA MODULE		
 <p>PM1 Power / Data Module</p>	<p>PM1 Overall: 5.25"w 1.25"d 4.25"h PM2 Overall: 2"w 2"d .125"h USB-1 Overall: 2"w 2"d .125"h</p>	<p>PM1 \$859 Power/Data Module (1-Power / 1-USB 2 Port Simplex Charger Standard) <i>Vertical / Horizontal Mount Power Module. Price Varies By Socket. Contact Customer Service For Quote. (Additional Colors Available)</i></p>
 <p>PM2 Power Module</p>  <p>USB-1 Dual Charging USB</p>	<p>PM2 \$238 Power Module (1-Power) <i>Spill-Proof Technology / Multiple Finish Options / Storm Color Standard (Specify Left or Right Facing)</i></p>	<p>USB-1 \$238 Dual Charging USB (2 Port Simplex Charger Standard) <i>Spill-Proof Technology / 2 Amps Per Port / Multiple Finish Options / Storm Color Standard (Specify Left or Right Facing)</i></p>
Available: Facelift Prime Low Leg Lounge		
CONTRASTING COVERS		
	<p>Overall: N/A</p>	<p>CC \$129</p>
<p><i>NOTE: If Two Or More Upholsteries Or Leathers Are Used On Any Piece Of Furniture, Then A Contrast Charge Will Apply Per Order. When Using Trinity Upholstery, The Higher Priced Upholstery Grade Will Be Used In Pricing, Unless It's Trinity Leather With Fabric Contrast Welt, Or COM With Trinity Contrast Welt, Then Contact Customer Service For Pricing.</i></p>		
Available: Facelift Prime Collection		

Facelift Prime

GUEST / TANDEM / BENCHES / TABLES

Effective: March 1, 2025

T R I N I T Y

Date:

Page:

Modification:

Description:

DESCRIPTION:

- Upholstery Frames: Steel, Plywood & Hardwood
- Seat: High Density Polyurethane Foam Over Strap Webbing
- Back: High Density Polyurethane Foam Over Sinuous Wire Springs
- Upholstered Covers: Attached w/ Velcro / Removable For Maintenance
- Exposed Wood Legs: Solid Hardwood / Removable For Maintenance
- Antimicrobial Moisture Barrier Fully Encapsulates All Foam Areas
- Leather Upholstery Not Available
- Lifetime Warranty

Behavioral Chair:

- Upholstery Frames: Steel, Plywood & Hardwood
- Recycled 22" Wide 1½" X 1½" Steel Inner-frame
- Seat: High Density Polyurethane Foam Over Sheet Webbing
- Back: High Density Polyurethane Foam Over Hardwood Plywood

- Arms: Held In Place By Non-Removable Helical Fasteners
- Exposed Wood Legs: Solid Hardwood / Removable For Maintenance
- Full Underbody Panel
- Tamperproof Screws On Seat Pan
- Full Clean-Out Between Seat & Back
- No Exposed Hardware Or "Pick Points"
- All Staples Are Concealed & Inaccessible

Behavioral Chair Enhancements:

- Vacuum Formed ABS Under Panel With Drain
- Additional Weight Can Be Added To The Seat
- Can Be Bolted To Floor
- Replaceable Seat Cover w/ Antimicrobial Moisture Barrier
- Bariatric 30" Wide 500lbs. Available

OPTIONS:

- WAC-2 Solid Wood Arm Caps (Set Of 2)\$143
- UAC-2 Black Urethane Arm Caps (Set Of 2)\$193
- PM1 Power/Data Module (1-Power / 1-USB 2 Port Simplex Charger)\$859
(Additional Power/Data Modules Available - See Prime Options)

Tablet Arm / Cup Holder Options (See Facelift Prime Guest/Tandem Options Page)
Specify Exposed Wood Finish (See Page 6)

Biscuit Tufting Available Upon Request (Contact Customer Service For Pricing)

NOTE: All Seating Configurations Are Viewed From Left To Right Facing. Please Attach A Layout Showing Seating Configuration w/ Your Order. Assembled Units Must Be Shipped In Configurations Of 3 Or Less.

GUEST / TANDEM

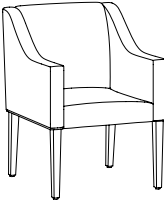
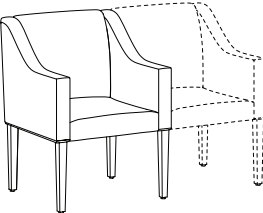
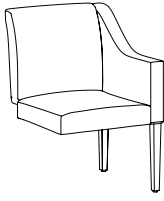
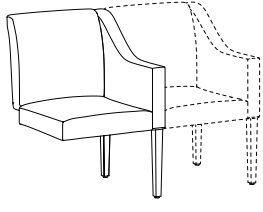
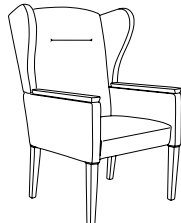
ITEM #:	SPECIFICATIONS GRADES LIST PRICES:														
COM	COL	1	2	3	4	5	6	7	8	9	10	L1	L2		
ARM SIDE CHAIR															
			Overall: 24"w 28"d 34"h			Arm: 26"h			COM: 4 yds.						
			Seat: 19"w 20"d 19"h			Weight: 60 lbs.			COL: n/a						
															
1720	1386	N/A	1526	1635	1743	1851	1959	2068	2176	2284	2392	2501	N/A	N/A	
	<i>Tight Seat & Back / Removable Upholstery / 350 lb. Weight Capacity</i>														
1720-R	181	N/A	408	526	645	764	882	1001	1119	1238	1356	1475	N/A	N/A	
	<i>Replacement Upholstery Covers</i>														
ARM CHAIR / ACCEPTS SEAT ON RIGHT															
			Overall: 24"w 28"d 34"h			Arm: 26"h			COM: 4 yds.						
			Seat: 19"w 20"d 19"h			Weight: 60 lbs.			COL: n/a						
															
1720-C	1386	N/A	1526	1635	1743	1851	1959	2068	2176	2284	2392	2501	N/A	N/A	
	<i>Tight Seat & Back / Removable Upholstery / 350 lb. Weight Capacity</i>														
1720-CR	181	N/A	408	526	645	764	882	1001	1119	1238	1356	1475	N/A	N/A	
	<i>Replacement Upholstery Covers</i>														
ARM CHAIR / ADD-A-SEAT															
			Overall: 21.5"w 28"d 34"h			Arm: 26"h			COM: 3 yds.						
			Seat: 19"w 20"d 19"h			Weight: 45 lbs.			COL: n/a						
															
1721	1052	N/A	1153	1232	1312	1391	1470	1550	1629	1709	1788	1867	N/A	N/A	
	<i>Tight Seat & Back / Removable Upholstery / 350 lb. Weight Capacity</i>														
1721-R	146	N/A	312	399	486	573	660	747	834	920	1007	1094	N/A	N/A	
	<i>Replacement Upholstery Covers</i>														
ARM CHAIR / ADD-A-SEAT / ACCEPTS SEAT ON RIGHT															
			Overall: 21.5"w 28"d 34"h			Arm: 26"h			COM: 3 yds.						
			Seat: 19"w 20"d 19"h			Weight: 45 lbs.			COL: n/a						
															
1721-C	1052	N/A	1153	1232	1312	1391	1470	1550	1629	1709	1788	1867	N/A	N/A	
	<i>Tight Seat & Back / Removable Upholstery / 350 lb. Weight Capacity</i>														
1721-CR	146	N/A	312	399	486	573	660	747	834	920	1007	1094	N/A	N/A	
	<i>Replacement Upholstery Covers</i>														
WINGBACK BEHAVIORAL HEALTH CHAIR / URETHANE ARMS															
			Overall: 26"w 28.5"d 46"h			Arm: 26.5"h			COM: 4 yds.						
			Seat: 21"w 20"d 19"h			Weight: 80 lbs.			COL: n/a						
															
BH1722-WB	2086	N/A	2188	2297	2405	2513	2621	2730	2838	2946	3054	3162	N/A	N/A	
	<i>Tight Seat & Back / Removable Upholstery Seat Only / 350 lb. Weight Capacity</i>														
Meets Behavioral Health Requirements															

DESCRIPTION:

- Upholstery Frames: Steel, Plywood & Hardwood
- Seat: High Density Polyurethane Foam Over Strap Webbing
- Back: High Density Polyurethane Foam Over Sinuous Wire Springs
- Upholstered Covers: Attached w/ Velcro / Removable For Maintenance
- Exposed Wood Legs: Solid Hardwood / Removable For Maintenance
- Antimicrobial Moisture Barrier Fully Encapsulates All Foam Areas
- Leather Upholstery Not Available
- Lifetime Warranty

OPTIONS:

- WAC-2 Solid Wood Arm Caps (Set Of 2)\$143
- UAC-2 Black Urethane Arm Caps (Set Of 2).....\$193
- PM1 Power/Data Module (1-Power / 1-USB 2 Port Simplex Charger)\$859
(Additional Power/Data Modules Available - See Prime Options)
- Tablet Arm / Cup Holder Options (See Facelift Prime Guest/Tandem Options Pages)
- Specify Exposed Wood Finish (See Page 6)
- Biscuit Tufting Available Upon Request (Contact Customer Service For Pricing)

NOTE: All Seating Configurations Are Viewed From Left To Right Facing. Please Attach A Layout Showing Seating Configuration w/ Your Order. Assembled Units Must Be Shipped In Configurations Of 3 Or Less.

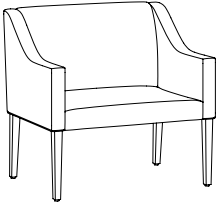
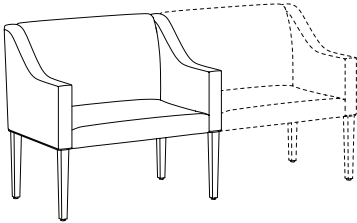
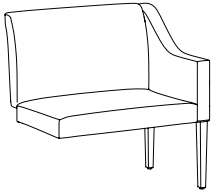
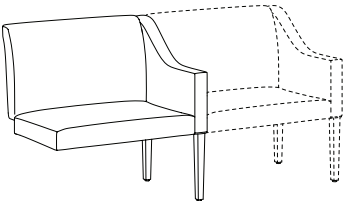
TANDEM / BARIATRIC		ITEM #:	SPECIFICATIONS GRADES LIST PRICES:													
BARIATRIC ARM SIDE CHAIR			Overall: 34"w 28"d 34"h			Arm: 26"h			COM: 4.25 yds.							
			Seat: 29"w 20"d 19"h			Weight: 65 lbs.			COL: n/a							
			COM	COL	1	2	3	4	5	6	7	8	9	10	L1	L2
	1730		1731	N/A	1867	1983	2098	2214	2329	2445	2560	2675	2791	2906	N/A	N/A
<i>Tight Seat & Back / Removable Upholstery / 500 lb. Weight Capacity</i>																
	1730-R		197	N/A	439	566	692	819	945	1072	1198	1325	1451	1577	N/A	N/A
<i>Replacement Upholstery Covers</i>																
BARIATRIC ARM CHAIR / ACCEPTS SEAT ON RIGHT			Overall: 34"w 28"d 34"h			Arm: 26"h			COM: 4.25 yds.							
			Seat: 29"w 20"d 19"h			Weight: 65 lbs.			COL: n/a							
			COM	COL	1	2	3	4	5	6	7	8	9	10	L1	L2
	1730-C		1731	N/A	1867	1983	2098	2214	2329	2445	2560	2675	2791	2906	N/A	N/A
<i>Tight Seat & Back / Removable Upholstery / 500 lb. Weight Capacity</i>																
	1730-CR		197	N/A	439	566	692	819	945	1072	1198	1325	1451	1577	N/A	N/A
<i>Replacement Upholstery Covers</i>																
BARIATRIC ARM CHAIR / ADD-A-SEAT			Overall: 31.5"w 28"d 34"h			Arm: 26"h			COM: 3.75 yds.							
			Seat: 29"w 20"d 19"h			Weight: 50 lbs.			COL: n/a							
			COM	COL	1	2	3	4	5	6	7	8	9	10	L1	L2
	1731		1402	N/A	1528	1629	1730	1831	1932	2033	2134	2235	2336	2437	N/A	N/A
<i>Tight Seat & Back / Removable Upholstery / 500 lb. Weight Capacity</i>																
	1731-R		162	N/A	374	485	595	706	817	927	1038	1149	1259	1370	N/A	N/A
<i>Replacement Upholstery Covers</i>																
BARIATRIC ARM CHAIR / ADD-A-SEAT / ACCEPTS SEAT ON RIGHT			Overall: 31.5"w 28"d 34"h			Arm: 26"h			COM: 3.75 yds.							
			Seat: 29"w 20"d 19"h			Weight: 50 lbs.			COL: n/a							
			COM	COL	1	2	3	4	5	6	7	8	9	10	L1	L2
	1731-C		1402	N/A	1528	1629	1730	1831	1932	2033	2134	2235	2336	2437	N/A	N/A
<i>Tight Seat & Back / Removable Upholstery / 500 lb. Weight Capacity</i>																
	1731-CR		162	N/A	374	485	595	706	817	927	1038	1149	1259	1370	N/A	N/A
<i>Replacement Upholstery Covers</i>																

DESCRIPTION:

- Upholstery Frames: Steel, Plywood & Hardwood
- Seat: High Density Polyurethane Foam Over Strap Webbing
- Back: High Density Polyurethane Foam Over Sinuous Wire Springs
- Upholstered Covers: Attached w/ Velcro / Removable For Maintenance
- Exposed Wood Legs: Solid Hardwood / Removable For Maintenance
- Antimicrobial Moisture Barrier Fully Encapsulates All Foam Areas
- Leather Upholstery Not Available
- Lifetime Warranty

OPTIONS:

- WAC-2 Solid Wood Arm Caps (Set Of 2)\$143
- UAC-2 Black Urethane Arm Caps (Set Of 2).....\$193
- PM1 Power/Data Module (1-Power / 1-USB 2 Port Simplex Charger)\$859
(Additional Power/Data Modules Available - See Prime Options)
- Tablet Arm / Cup Holder Options (See Facelift Prime Guest/Tandem Options Pages)
- Specify Exposed Wood Finish (See Page 6)
- Biscuit Tufting Available Upon Request (Contact Customer Service For Pricing)

NOTE: All Seating Configurations Are Viewed From Left To Right Facing. Please Attach A Layout Showing Seating Configuration w/ Your Order. Assembled Units Must Be Shipped In Configurations Of 3 Or Less.

TANDEM

ITEM #: SPECIFICATIONS | GRADES | LIST PRICES:

TWO PLACE SOFA

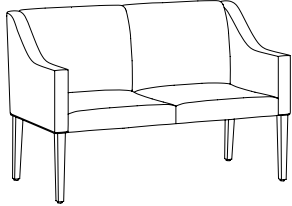

Overall: 52"w 28"d 34"h **Arm:** 26"h **COM:** 5.25 yds.
Seat: 47"w 20"d 19"h **Weight:** 135 lbs. **COL:** n/a

COM	COL	1	2	3	4	5	6	7	8	9	10	L1	L2
1748	N/A	2401	2545	2690	2834	2978	3123	3267	3411	3556	3700	N/A	N/A
<i>Tight Seat & Back / Removable Upholstery / 750 lb. Weight Capacity</i>													
1748-R	N/A	604	762	920	1078	1236	1394	1552	1710	1868	2027	N/A	N/A
<i>Replacement Upholstery Covers</i>													

TWO PLACE SOFA / ACCEPTS SEAT ON RIGHT

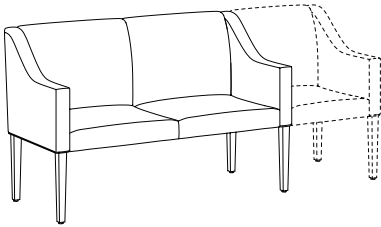

Overall: 52"w 28"d 34"h **Arm:** 26"h **COM:** 5.25 yds.
Seat: 47"w 20"d 19"h **Weight:** 135 lbs. **COL:** n/a

COM	COL	1	2	3	4	5	6	7	8	9	10	L1	L2
1748-C	N/A	2401	2545	2690	2834	2978	3123	3267	3411	3556	3700	N/A	N/A
<i>Tight Seat & Back / Removable Upholstery / 750 lb. Weight Capacity</i>													
1748-CR	N/A	604	762	920	1078	1236	1394	1552	1710	1868	2027	N/A	N/A
<i>Replacement Upholstery Covers</i>													

TWO PLACE SOFA / ADD-A-SEAT

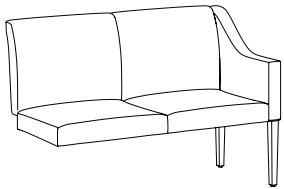

Overall: 49.5"w 28"d 34"h **Arm:** 26"h **COM:** 4.75 yds.
Seat: 47"w 20"d 19"h **Weight:** 120 lbs. **COL:** n/a

COM	COL	1	2	3	4	5	6	7	8	9	10	L1	L2
1749	N/A	2042	2172	2302	2432	2562	2692	2821	2951	3081	3211	N/A	N/A
<i>Tight Seat & Back / Removable Upholstery / 750 lb. Weight Capacity</i>													
1749-R	N/A	500	642	784	926	1069	1211	1353	1495	1638	1780	N/A	N/A
<i>Replacement Upholstery Covers</i>													

TWO PLACE SOFA / ADD-A-SEAT / ACCEPTS SEAT ON RIGHT

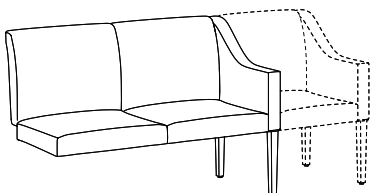

Overall: 49.5"w 28"d 34"h **Arm:** 26"h **COM:** 4.75 yds.
Seat: 47"w 20"d 19"h **Weight:** 120 lbs. **COL:** n/a

COM	COL	1	2	3	4	5	6	7	8	9	10	L1	L2
1749-C	N/A	2042	2172	2302	2432	2562	2692	2821	2951	3081	3211	N/A	N/A
<i>Tight Seat & Back / Removable Upholstery / 750 lb. Weight Capacity</i>													
1749-CR	N/A	500	642	784	926	1069	1211	1353	1495	1638	1780	N/A	N/A
<i>Replacement Upholstery Covers</i>													

DESCRIPTION:

- Upholstery Frames: Steel, Plywood & Hardwood
- Seat: High Density Polyurethane Foam Over Strap Webbing
- Upholstered Covers: Attached w/ Velcro / Removable For Maintenance
- Exposed Wood Legs: Solid Hardwood / Removable For Maintenance
- Antimicrobial Moisture Barrier Fully Encapsulates All Foam Areas
- Leather Upholstery Not Available
- Lifetime Warranty

OPTIONS:

- 26HA 26" High Arms.....\$50 Per Arm
 - ARL Brushed Aluminum Round Legs (Set Of 4).....\$353
 - PM1 Power/Data Module (1-Power / 1-USB 2 Port Simplex Charger)\$859
(Additional Power/Data Modules Available - See Prime Options)
- Specify Exposed Wood Finish (See Page 6)
Biscuit Tufting Available Upon Request (Contact Customer Service For Pricing)

NOTE: All Seating Configurations Are Viewed From Left To Right Facing. Please Attach A Layout Showing Seating Configuration w/ Your Order. Assembled Units Must Be Shipped In Configurations Of 3 Or Less.

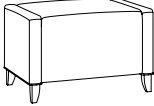
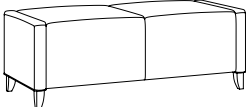
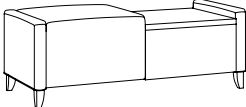
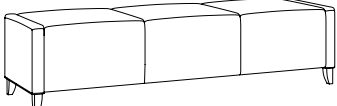
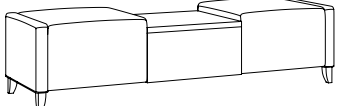
BENCHES		ITEM #:	SPECIFICATIONS GRADES LIST PRICES:												
	BENCH / OTTOMAN		<i>Overall: 28"w 22"d 19"h</i>			<i>Arm: n/a</i>			<i>COM: 3.25 yds.</i>						
	<i>Seat: 23"w 22"d 19"h</i>			<i>Weight: 40 lbs.</i>			<i>COL: n/a</i>								
		COM	COL	1	2	3	4	5	6	7	8	9	10	L1	L2
	1761	1097	N/A	1210	1297	1384	1470	1557	1643	1730	1817	1903	1990	N/A	N/A
	1761-R	<i>Removable Upholstery / 500 lb. Weight Capacity</i>													
		169	N/A	349	444	539	634	729	824	918	1013	1108	1203	N/A	N/A
		<i>Replacement Upholstery Covers</i>													
	TWO SEAT BENCH		<i>Overall: 52"w 22"d 19"h</i>			<i>Arm: n/a</i>			<i>COM: 4.5 yds.</i>						
	<i>Seat: 47"w 22"d 19"h</i>			<i>Weight: 60 lbs.</i>			<i>COL: n/a</i>								
		COM	COL	1	2	3	4	5	6	7	8	9	10	L1	L2
	1762	1703	N/A	1856	1978	2101	2224	2346	2469	2592	2714	2837	2960	N/A	N/A
	1762-R	<i>Removable Upholstery / 500 lb. Weight Capacity</i>													
		218	N/A	475	609	744	878	1012	1147	1281	1415	1550	1684	N/A	N/A
		<i>Replacement Upholstery Covers</i>													
	SEAT / TABLE BENCH		<i>Overall: 52"w 22"d 19"h</i>			<i>Arm: n/a</i>			<i>COM: 3.25 yds.</i>						
	<i>Seat: 47"w 22"d 19"h</i>			<i>Weight: 70 lbs.</i>			<i>COL: n/a</i>								
		COM	COL	1	2	3	4	5	6	7	8	9	10	L1	L2
	1762-ST	1970	N/A	2036	2123	2209	2296	2382	2469	2556	2642	2729	2815	N/A	N/A
	1761-R	<i>Removable Upholstery / High Pressure Laminate Top (Square Edge) / 500 lb. Weight Capacity</i>													
		169	N/A	349	444	539	634	729	824	918	1013	1108	1203	N/A	N/A
		<i>Replacement Upholstery Covers</i>													
	THREE SEAT BENCH		<i>Overall: 76"w 22"d 19"h</i>			<i>Arm: n/a</i>			<i>COM: 6 yds.</i>						
	<i>Seat: 71"w 22"d 19"h</i>			<i>Weight: 85 lbs.</i>			<i>COL: n/a</i>								
		COM	COL	1	2	3	4	5	6	7	8	9	10	L1	L2
	1763	2242	N/A	2452	2618	2784	2950	3116	3282	3448	3614	3779	3945	N/A	N/A
	1763-R	<i>Removable Upholstery / 500 lb. Weight Capacity</i>													
		267	N/A	616	798	980	1162	1343	1525	1707	1889	2070	2252	N/A	N/A
		<i>Replacement Upholstery Covers</i>													
	SEAT / TABLE / SEAT BENCH		<i>Overall: 76"w 22"d 19"h</i>			<i>Arm: n/a</i>			<i>COM: 4.5 yds.</i>						
	<i>Seat: 71"w 22"d 19"h</i>			<i>Weight: 95 lbs.</i>			<i>COL: n/a</i>								
		COM	COL	1	2	3	4	5	6	7	8	9	10	L1	L2
	1763-ST	2503	N/A	2612	2735	2857	2980	3103	3225	3348	3471	3593	3716	N/A	N/A
	1762-R	<i>Removable Upholstery / High Pressure Laminate Top (Square Edge) / 500 lb. Weight Capacity</i>													
		218	N/A	475	609	744	878	1012	1147	1281	1415	1550	1684	N/A	N/A
		<i>Replacement Upholstery Covers</i>													

DESCRIPTION:

- Upholstery Frames: Steel, Plywood & Hardwood
- Seat: High Density Polyurethane Foam Over Strap Webbing
- Upholstered Covers: Attached w/ Velcro / Removable For Maintenance
- Exposed Wood Legs: Solid Hardwood / Removable For Maintenance
- Antimicrobial Moisture Barrier Fully Encapsulates All Foam Areas
- Leather Upholstery Not Available
- Lifetime Warranty

OPTIONS:

- 26HA 26" High Arms\$50 Per Arm
- PM1 Power/Data Module (1-Power / 1-USB 2 Port Simplex Charger)\$859
(Additional Power/Data Modules Available - See Prime Options)
- Specify Exposed Wood Finish (See Page 6)
- Biscuit Tufting Available Upon Request (Contact Customer Service For Pricing)
- Veneer Table Tops (Contact Factory)

NOTE: All Seating Configurations Are Viewed From Left To Right Facing. Please Attach A Layout Showing Seating Configuration w/ Your Order. Assembled Units Must Be Shipped In Configurations Of 3 Or Less.

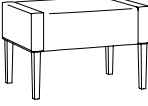
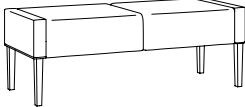
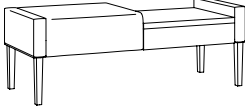
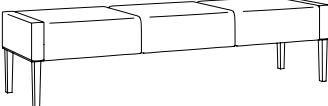
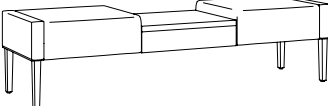
BENCHES		ITEM #:	SPECIFICATIONS GRADES LIST PRICES:												
BENCH / OTTOMAN 			Overall: 28"w 22"d 19"h			Arm: n/a			COM: 2 yds.						
			Seat: 23"w 22"d 19"h			Weight: 40 lbs.			COL: n/a						
			COM	COL	1	2	3	4	5	6	7	8	9	10	L1
	1771	1032	N/A	1077	1127	1178	1228	1279	1329	1380	1431	1481	1532	N/A	N/A
		<i>Removable Upholstery / 350 lb. Weight Capacity</i>													
	1771-R	162	N/A	263	319	374	429	485	540	595	651	706	761	N/A	N/A
		<i>Replacement Upholstery Covers</i>													
TWO SEAT BENCH 			Overall: 52"w 22"d 19"h			Arm: n/a			COM: 3.25 yds.						
			Seat: 47"w 22"d 19"h			Weight: 50 lbs.			COL: n/a						
			COM	COL	1	2	3	4	5	6	7	8	9	10	L1
	1772	1596	N/A	1682	1768	1855	1941	2028	2115	2201	2288	2374	2461	N/A	N/A
		<i>Removable Upholstery / 750 lb. Weight Capacity</i>													
	1772-R	211	N/A	389	484	579	673	768	863	958	1053	1148	1243	N/A	N/A
		<i>Replacement Upholstery Covers</i>													
SEAT / TABLE BENCH 			Overall: 52"w 22"d 19"h			Arm: n/a			COM: 2 yds.						
			Seat: 47"w 22"d 19"h			Weight: 60 lbs.			COL: n/a						
			COM	COL	1	2	3	4	5	6	7	8	9	10	L1
	1772-ST	1783	N/A	1787	1837	1888	1939	1989	2040	2090	2141	2191	2242	N/A	N/A
		<i>Removable Upholstery / High Pressure Laminate Top (Square Edge) / 750 lb. Weight Capacity</i>													
	1771-R	162	N/A	263	319	374	429	485	540	595	651	706	761	N/A	N/A
		<i>Replacement Upholstery Covers</i>													
THREE SEAT BENCH 			Overall: 76"w 22"d 19"h			Arm: n/a			COM: 4 yds.						
			Seat: 71"w 22"d 19"h			Weight: 70 lbs.			COL: n/a						
			COM	COL	1	2	3	4	5	6	7	8	9	10	L1
	1773	2071	N/A	2175	2283	2391	2500	2608	2716	2824	2932	3041	3149	N/A	N/A
		<i>Removable Upholstery / 750 lb. Weight Capacity / 750 lb. Weight Capacity</i>													
	1773-R	260	N/A	483	601	720	839	957	1076	1194	1313	1431	1550	N/A	N/A
		<i>Replacement Upholstery Covers</i>													
SEAT / TABLE / SEAT BENCH 			Overall: 76"w 22"d 19"h			Arm: n/a			COM: 3.25 yds.						
			Seat: 71"w 22"d 19"h			Weight: 80 lbs.			COL: n/a						
			COM	COL	1	2	3	4	5	6	7	8	9	10	L1
	1773-ST	2285	N/A	2334	2421	2507	2594	2680	2767	2854	2940	3027	3113	N/A	N/A
		<i>Removable Upholstery / High Pressure Laminate Top (Square Edge) / 750 lb. Weight Capacity</i>													
	1772-R	211	N/A	389	484	579	673	768	863	958	1053	1148	1243	N/A	N/A
		<i>Replacement Upholstery Covers</i>													

DESCRIPTION:

- Exposed Frames: Solid Maple, Self Edge, Vertical Direction
- Wilsonart Plastic Laminates Standard. Alternate Selections May Be Specified From Most Major Laminate Manufacturers. (Contact Factory For Availability)
- Lifetime Warranty



OPTIONS:



Specify Exposed Wood Finish / Laminate (See Page 6)



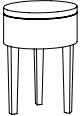
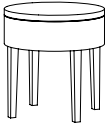
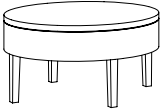



Square Edge Profile Standard

NOTE: All Seating Configurations Are Viewed From Left To Right Facing. Please Attach A Layout Showing Seating Configuration w/ Your Order. Assembled Units Must Be Shipped In Configurations Of 3 Or Less.

TABLES	ITEM #:	SPECIFICATIONS GRADES LIST PRICES:													
<p>END TABLE / THREE LEG BASE</p> 		<p>Overall: 16" Diameter 23"h Weight: 20 lbs.</p>													
		COM	COL	1	2	3	4	5	6	7	8	9	10	L1	L2
	1716D23-L	897	High Pressure Laminate Face / Self Edge												
	1716D23-C	1137	Solid Surface Face (Glacier White) / Self Edge												
<p>END TABLE</p> 		<p>Overall: 22" Diameter 23"h Weight: 37 lbs.</p>													
		COM	COL	1	2	3	4	5	6	7	8	9	10	L1	L2
	1722D23-L	1043	High Pressure Laminate Face / Self Edge												
	1722D23-C	1468	Solid Surface Face (Glacier White) / Self Edge												
<p>COFFEE TABLE</p> 		<p>Overall: 36" Diameter 18"h Weight: 40 lbs.</p>													
		COM	COL	1	2	3	4	5	6	7	8	9	10	L1	L2
	1736D18-L	2155	High Pressure Laminate Face / Self Edge												
	1736D18-C	3191	Solid Surface Face (Glacier White) / Self Edge												
<p>18" / 180° ADJUSTABLE TABLE / CONNECTS ANY TANDEM CHAIR</p> 		<p>Overall: 18" Diameter Weight: 25 lbs.</p>													
		COM	COL	1	2	3	4	5	6	7	8	9	10	L1	L2
	1718DC-L	735	High Pressure Laminate Face												
	1718DC-C	897	Solid Surface Face (Glacier White) / Self Edge												
<p>22" / 180° ADJUSTABLE TABLE / CONNECTS ANY TANDEM CHAIR</p> 		<p>Overall: 22" Diameter Weight: 25 lbs.</p>													
		COM	COL	1	2	3	4	5	6	7	8	9	10	L1	L2
	1722DC-L	747	High Pressure Laminate Face												
	1722DC-C	1071	Solid Surface Face (Glacier White) / Self Edge												

ARM CAPS / LEGS	OPTION #:	SPECIFICATIONS LIST PRICES AVAILABILITY:
<p>SOLID WOOD ARM CAPS</p> 	<p>WAC-2</p>	<p><i>Overall: 3.25"w 15"d 1.25"h</i></p> <hr/> <p>\$143 <i>(Specify Finish)</i></p> <p><i>Available: Facelift Prime Guest / Tandem Units</i></p>
<p>URETHANE ARM CAPS</p> 	<p>UAC-2</p>	<p><i>Overall: 3.25"w 15"d 1.25"h</i></p> <hr/> <p>\$193 <i>(Black Urethane)</i></p> <p><i>Available: Facelift Prime Guest / Tandem Units</i></p>
<p>BRUSHED ALUMINUM ROUND LEGS</p> 	<p>ARL</p>	<p><i>Overall: 2" Diameter 5"h</i></p> <hr/> <p>\$353 (Set Of 4) <i>(Brushed Aluminum Finish)</i></p> <p><i>Available: Facelift Prime Low Leg Benches (1761, 1762,1762-ST, 1763, 1763-STs)</i></p>

POWER / ARMS / COVERS	OPTION #:	SPECIFICATIONS LIST PRICES AVAILABILITY:
<p>POWER / DATA MODULE</p>  <p>PM1 Power / Data Module</p>  <p>PM2 Power Module</p>  <p>USB-1 Dual Charging USB</p>	<p>PM1</p> <p>PM2</p> <p>USB-1</p>	<p>PM1 Overall: 5.25"w 1.25"d 4.25"h PM2 Overall: 2"w 2"d .125"h USB-1 Overall: 2"w 2"d .125"h</p> <p>\$859 Power/Data Module (1-Power / 1-USB 2 Port Simplex Charger Standard) <i>Vertical / Horizontal Mount Power Module. Price Varies By Socket. Contact Customer Service For Quote. (Additional Colors Available)</i></p> <p>\$238 Power Module (1-Power) <i>Spill-Proof Technology / Multiple Finish Options / Storm Color Standard (Specify Left or Right Facing)</i></p> <p>\$238 Dual Charging USB (2 Port Simplex Charger Standard) <i>Spill-Proof Technology / 2 Amps Per Port / Multiple Finish Options / Storm Color Standard (Specify Left or Right Facing)</i></p> <p>Available: Facelift Prime Guest / Tandem</p>
<p>26" HIGH ARMS</p> 	<p>26HA</p>	<p>Overall: 2.75"w 22"d 26"h</p> <p>\$50 (Per Arm) <i>26" High Arms For Benches (Specify Fabric)</i></p> <p>Available: Facelift Prime Benches</p>
<p>CONTRASTING COVERS</p> 	<p>CC</p>	<p>Overall: N/A</p> <p>\$129 <i>NOTE: If Two Or More Upholsteries Or Leathers Are Used On Any Piece Of Furniture, Then A Contrast Charge Will Apply Per Order. When Using Trinity Upholstery, The Higher Priced Upholstery Grade Will Be Used In Pricing, Unless It's Trinity Leather With Fabric Contrast Welt, Or COM With Trinity Contrast Welt, Then Contact Customer Service For Pricing.</i></p> <p>Available: Facelift Prime Collection</p>

Facelift Revival

LOUNGE / BENCHES

Effective: March 1, 2025

T R I N I T Y

Date:

Page:

Modification:

Description:

DESCRIPTION:

- Upholstery Frames: Steel, Plywood & Hardwood
- Seat: High Density Polyurethane Foam Over Strap Webbing
- Back: High Density Polyurethane Foam Over Sinuous Wire Springs
- Upholstered Covers: Attached w/ Velcro / Removable For Maintenance
- Antimicrobial Moisture Barrier Fully Encapsulates All Foam Areas
- Double Needle Stitching Standard (Welting Optional - No Charge)
- Exposed Wood Legs: Solid Hardwood / Removable For Maintenance
- Leather Upholstery Not Available
- Lifetime Warranty

OPTIONS:

- ARL Brushed Aluminum Round Legs (Set Of 4).....\$353
- PM1 Power/Data Module (1-Power / 1-USB 2 Port Simplex Charger)\$859
(Additional Power/Data Modules Available - See Revival Options)

Feather Down & Polyester Pillows Available (See Page 5)
Specify Exposed Wood Finish (See Page 6)

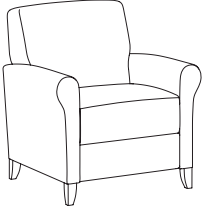
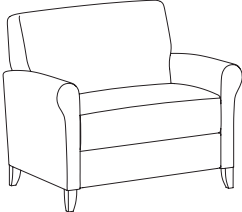
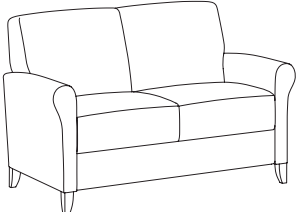
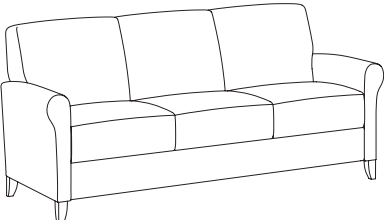
LOUNGE		ITEM #:	SPECIFICATIONS GRADES LIST PRICES:													
	LOUNGE CHAIR / FULLY UPHOLSTERED	1801 1801-R	Overall: 31"w 32"d 34"h Seat: 21"w 20"d 18.5"h			Arm: 24"h Weight: 82 lbs.			COM: 4.75 yds. COL: n/a							
			COM	COL	1	2	3	4	5	6	7	8	9	10	L1	L2
			1562	N/A	1674	1827	1957	2087	2217	2347	2476	2606	2736	2866	N/A	N/A
			<i>Tight Seat & Back / Removable Upholstery / 500 lb. Weight Capacity</i>													
<i>Replacement Upholstery Covers</i>																
	BARIATRIC LOUNGE CHAIR / FULLY UPHOLSTERED	1801-X 1801-XR	Overall: 39.5"w 32"d 34"h Seat: 29.5"w 20"d 18.5"h			Arm: 24"h Weight: 95 lbs.			COM: 5.25 yds. COL: n/a							
			COM	COL	1	2	3	4	5	6	7	8	9	10	L1	L2
			1807	N/A	1997	2142	2286	2430	2575	2719	2863	3008	3152	3296	N/A	N/A
			<i>Tight Seat & Back / Removable Upholstery / 1000 lb. Weight Capacity</i>													
<i>Replacement Upholstery Covers</i>																
	TWO PLACE SOFA / FULLY UPHOLSTERED	1802 1802-R	Overall: 57"w 32"d 34"h Seat: 47.5"w 20"d 18.5"h			Arm: 24"h Weight: 120 lbs.			COM: 6.75 yds. COL: n/a							
			COM	COL	1	2	3	4	5	6	7	8	9	10	L1	L2
			2434	N/A	2666	2833	2970	3157	3345	3532	3720	3908	4095	4283	N/A	N/A
			<i>Tight Seat & Back / Removable Upholstery / 1000 lb. Weight Capacity</i>													
<i>Replacement Upholstery Covers</i>																
	THREE PLACE SOFA / FULLY UPHOLSTERED	1803 1803-R	Overall: 80"w 32"d 34"h Seat: 70.5"w 20"d 18.5"h			Arm: 24"h Weight: 155 lbs.			COM: 8.75 yds. COL: n/a							
			COM	COL	1	2	3	4	5	6	7	8	9	10	L1	L2
			3229	N/A	3544	3789	4035	4280	4525	4771	5016	5261	5507	5752	N/A	N/A
			<i>Tight Seat & Back / Removable Upholstery / 1000 lb. Weight Capacity</i>													
<i>Replacement Upholstery Covers</i>																



DESCRIPTION:

- Upholstery Frames: Steel, Plywood & Hardwood
- Seat: High Density Polyurethane Foam Over Strap Webbing
- Back: High Density Polyurethane Foam Over Sinuous Wire Springs
- Upholstered Covers: Attached w/ Velcro / Removable For Maintenance
- Antimicrobial Moisture Barrier Fully Encapsulates All Foam Areas
- Double Needle Stitching Standard (Welting Optional - No Charge)
- Exposed Wood Legs: Solid Hardwood / Removable For Maintenance
- Leather Upholstery Not Available
- Lifetime Warranty

OPTIONS:

- ARL Brushed Aluminum Round Legs (Set Of 4).....\$353
- PM1 Power/Data Module (1-Power / 1-USB 2 Port Simplex Charger)\$859
(Additional Power/Data Modules Available - See Revival Options)
- 24HA 24" High Arms For Bench\$80 Per Arm

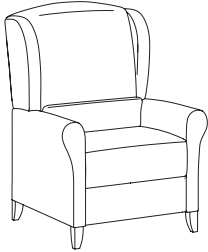
Feather Down & Polyester Pillows Available (See Page 5)
Specify Exposed Wood Finish (See Page 6)

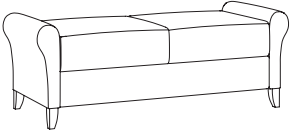
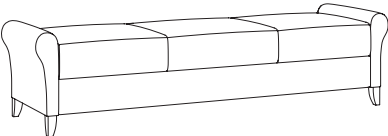
LOUNGE / BENCHES		ITEM #:	SPECIFICATIONS GRADES LIST PRICES:													
			Overall: 31"w 32"d 42"h			Arm: 24"h			COM: 6.25 yds.							
			Seat: 21"w 20"d 18.5"h			Weight: 115 lbs.			COL: n/a							
			COM	COL	1	2	3	4	5	6	7	8	9	10	L1	L2
	1815		1746	N/A	1997	2170	2343	2516	2690	2863	3036	3209	3382	3556	N/A	N/A
			<i>Tight Seat & Back / Adjustable Semi-Attached Pillow-Lumbar / Removable Upholstery / 500 lb. Weight Capacity</i>													
	1815-R		313	N/A	660	842	1023	1205	1387	1569	1750	1932	2114	2296	N/A	N/A
			<i>Replacement Upholstery Covers</i>													
			Overall: 22"w 18"d 15"h			Arm: n/a			COM: 1.75 yds.							
			Seat: 15"h			Weight: 18 lbs.			COL: n/a							
			COM	COL	1	2	3	4	5	6	7	8	9	10	L1	L2
	1816		554	N/A	611	654	697	741	784	827	871	914	957	1000	N/A	N/A
			<i>Tight Seat / Removable Upholstery / 500 lb. Weight Capacity</i>													
	1816-R		121	N/A	209	257	304	351	399	446	494	541	589	636	N/A	N/A
			<i>Replacement Upholstery Covers</i>													
			Overall: 56"w 23"d 20"h			Arm: 20"h			COM: 4 yds.							
			Seat: 18"h			Weight: 90 lbs.			COL: n/a							
			COM	COL	1	2	3	4	5	6	7	8	9	10	L1	L2
	1818		1639	N/A	1766	1874	1982	2091	2199	2307	2415	2524	2632	2740	N/A	N/A
			<i>Tight Seat & Back / Removable Upholstery / 1000 lb. Weight Capacity</i>													
	1818-R		208	N/A	434	553	671	790	908	1027	1145	1264	1383	1501	N/A	N/A
			<i>Replacement Upholstery Covers</i>													
			Overall: 81"w 23"d 20"h			Arm: 20"h			COM: 5.25 yds.							
			Seat: 18"h			Weight: 115 lbs.			COL: n/a							
			COM	COL	1	2	3	4	5	6	7	8	9	10	L1	L2
	1819		2176	N/A	2346	2491	2635	2779	2924	3068	3212	3356	3501	3645	N/A	N/A
			<i>Tight Seat & Back / Removable Upholstery / 1000 lb. Weight Capacity</i>													
	1819-R		251	N/A	554	712	870	1028	1186	1344	1502	1660	1818	1976	N/A	N/A
			<i>Replacement Upholstery Covers</i>													

LEGS / ARMS / POWER / COVERS	OPTION #:	SPECIFICATIONS LIST PRICES AVAILABILITY:
<p>BRUSHED ALUMINUM ROUND LEGS</p> 	<p>ARL</p>	<p>Overall: 2" Diameter 5"h</p> <hr/> <p>\$353 (Set Of 4) <i>(Brushed Aluminum Finish)</i></p> <p>Available: <i>Facelift Revival Collection</i></p>
<p>24" HIGH ARMS</p> 	<p>24HA</p>	<p>Overall: 5"w 23"d 24"h</p> <hr/> <p>\$80 (Per Arm) <i>24" High Arms For Bench (Specify Fabric)</i></p> <p>Available: <i>Facelift Revival Benches</i></p>
<p>POWER / DATA MODULE</p>  <p>PM1 Power / Data Module</p>  <p>PM2 Power Module</p>  <p>USB-1 Dual Charging USB</p>	<p>PM1</p> <p>PM2</p> <p>USB-1</p>	<p>PM1 Overall: 5.25"w 1.25"d 4.25"h PM2 Overall: 2"w 2"d .125"h USB-1 Overall: 2"w 2"d .125"h</p> <hr/> <p>\$859 Power/Data Module (1-Power / 1-USB 2 Port Simplex Charger Standard) <i>Vertical / Horizontal Mount Power Module. Price Varies By Socket. Contact Customer Service For Quote. (Additional Colors Available)</i></p> <p>\$238 Power Module (1-Power) <i>Spill-Proof Technology / Multiple Finish Options / Storm Color Standard (Specify Left or Right Facing)</i></p> <p>\$238 Dual Charging USB (2 Port Simplex Charger Standard) <i>Spill-Proof Technology / 2 Amps Per Port / Multiple Finish Options / Storm Color Standard (Specify Left or Right Facing)</i></p> <p>Available: <i>Facelift Revival Collection</i></p>
<p>CONTRASTING COVERS</p> 	<p>CC</p>	<p>Overall: <i>N/A</i></p> <hr/> <p>\$129</p> <p><i>NOTE: If Two Or More Upholsteries Or Leathers Are Used On Any Piece Of Furniture, Then A Contrast Charge Will Apply Per Order. When Using Trinity Upholstery, The Higher Priced Upholstery Grade Will Be Used In Pricing, Unless It's Trinity Leather With Fabric Contrast Welt, Or COM With Trinity Contrast Welt, Then Contact Customer Service For Pricing.</i></p> <p>Available: <i>Facelift Revival Collection</i></p>

Facelift Revival

HEALTHCARE MOTION

Effective: March 1, 2025

T R I N I T Y

Date:

Page:

Modification:

Description:

DESCRIPTION:

- Upholstery Frames: Steel, Plywood & Hardwood
- Seat: High Density Polyurethane Foam Over Sheet Webbing
- Back: High Density Polyurethane Foam Over Polypropylene Webbing
- Upholstered Covers: Attached w/ Velcro / Removable For Maintenance
- Removable Bolster Pillow For 1804 / 1805 (5" Diameter)
- Antimicrobial Moisture Barrier Fully Encapsulates All Foam Areas
- Double Needle Stitching Standard (Welting Optional - No Charge)
- Metal To Metal Connections For All Hardware Assembly
- Leather Upholstery Not Available
- Lifetime Warranty

OPTIONS:

- LC Locking Casters (Set Of 2)\$44
- NLC Non-Locking Casters (Set Of 2).....\$37
- 3LC 3" Locking Casters - #1806 Model Only (Set Of 2).....\$218
- PM1 Power/Data Module (1-Power / 1-USB 2 Port Simplex Charger)\$859
(Additional Power/Data Modules Available - See Revival Options)

Feather Down & Polyester Pillows Available (See Page 5)
Specify Exposed Wood Finish (See Page 6)

SLEEPOVER UNITS

ITEM #: SPECIFICATIONS | GRADES | LIST PRICES:

LOUNGE CHAIR / FULLY UPHOLSTERED

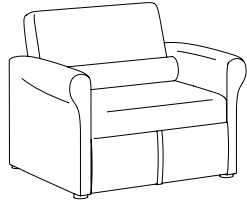

Healthcare Motion

		Overall: 40"w 34.5"d 33"h				Overall Length: 84"d				Arm: 24"h		COM: 6.5 yds.	
		Sleep Area: 28"w 80"d				Seat: 28"w 23"d 17.5"h				Weight: 175 lbs.		COL: n/a	
COM	COL	1	2	3	4	5	6	7	8	9	10	L1	L2
1804	N/A	4767	4947	5128	5308	5488	5669	5849	6030	6210	6390	N/A	N/A
<i>Tight Seat & Back / Removable Upholstery / 500 lb. Weight Capacity</i>													
1804-R	N/A	681	879	1076	1274	1471	1669	1867	2064	2262	2459	N/A	N/A
<i>Replacement Upholstery Covers</i>													

TWO PLACE SOFA / FULLY UPHOLSTERED

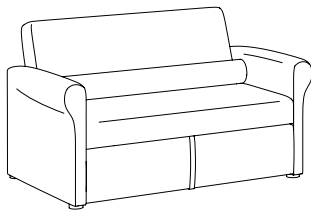

Healthcare Motion

		Overall: 60"w 34.5"d 33"h				Overall Length: 84"d				Arm: 24"h		COM: 9 yds.	
		Sleep Area: 48"w 80"d				Seat: 48"w 23"d 17.5"h				Weight: 225 lbs.		COL: n/a	
COM	COL	1	2	3	4	5	6	7	8	9	10	L1	L2
1805	N/A	6092	6345	6597	6850	7102	7355	7608	7860	8113	8365	N/A	N/A
<i>Tight Seat & Back / Removable Upholstery / 750 lb. Weight Capacity</i>													
1805-R	N/A	894	1170	1447	1723	2000	2277	2553	2830	3107	3383	N/A	N/A
<i>Replacement Upholstery Covers</i>													

FOUR POSITION ADJUSTMENT FOR 1804 / 1805

See Replay Healthcare Motion And Evolve Healthcare Motion For Additional Sleeper Units.



1) Closed Position



2) Ottoman Position



3) Chaise Position



4) Full-Recline Position
Overall Length - 84"d

BACK-FLIP SLEEPER SOFA

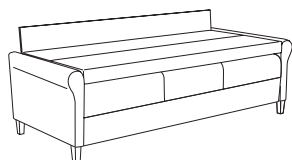
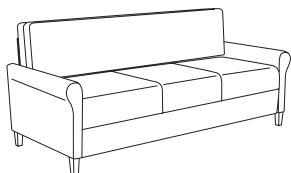

		Overall: 80"w 36"d 36"h				Arm: 24.5"h				COM: 12.75 yds.			
		Sleep Area: 70"w 31"d 20"h				Weight: 235 lbs.				COL: n/a			
COM	COL	1	2	3	4	5	6	7	8	9	10	L1	L2
1806	N/A	4729	5090	5451	5812	6173	6533	6894	7255	7616	7977	N/A	N/A
<i>Tight Seat & Back / Removable Upholstery / 1000 lbs. Weight Capacity</i>													
1806-R	N/A	1911	2306	2701	3096	3491	3887	4282	4677	5072	5467	N/A	N/A
<i>Replacement Upholstery Covers</i>													







DESCRIPTION:

- Upholstery Frames: Steel, Plywood & Hardwood
- Seat: High Density Polyurethane Foam Over Sheet Webbing
- Back: High Density Polyurethane Foam Over Polypropylene Webbing
- Upholstered Covers: Attached w/ Velcro / Removable For Maintenance
- Antimicrobial Moisture Barrier Fully Encapsulates All Foam Areas
- Double Needle Stitching Standard (Wetling Optional - No Charge)
- Exposed Wood Legs: Solid Hardwood / Removable For Maintenance
- Leather Upholstery Not Available
- Lifetime Warranty

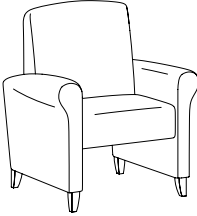
OPTIONS:

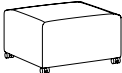
- ARL Brushed Aluminum Round Legs (Set Of 4).....\$353
- LC Locking Casters For 1809 Ottoman (Set Of 2)\$44
- WR Wood Ring Base - Replaces Metal Base On 1810-G/1810-SG\$224
- PM1 Power/Data Module (1-Power / 1-USB 2 Port Simplex Charger)\$859
(Additional Power/Data Modules Available - See Revival Options)

Feather Down & Polyester Pillows Available (See Page 5)
Specify Exposed Wood Finish (See Page 6)

PATIENT CHAIR / GLIDER		ITEM #:	SPECIFICATIONS GRADES LIST PRICES:													
		1808	Overall: 32.5"w 35.5"d 38"h			Arm: 24"h			COM: 5.25 yds.							
			Seat: 21"w 20"d 18"h			Weight: 63 lbs.			COL: n/a							
			COM	COL	1	2	3	4	5	6	7	8	9	10	L1	L2
			1721	N/A	1961	2128	2295	2462	2629	2796	2963	3130	3297	3464	N/A	N/A
			<i>Tight Seat & Back / Removable Upholstery / 500 lb. Weight Capacity</i>													
		1808-R	224	N/A	528	686	844	1003	1161	1319	1477	1635	1793	1951	N/A	N/A
			<i>Replacement Upholstery Covers</i>													
																
		1809	Overall: 18"w 18"d 11"h			Arm: n/a			COM: 1 yd.							
			Seat: n/a			Weight: 25 lbs.			COL: n/a							
			COM	COL	1	2	3	4	5	6	7	8	9	10	L1	L2
			386	N/A	409	430	452	474	495	517	539	560	582	603	N/A	N/A
			<i>Removable Upholstery / 350 lb. Weight Capacity</i>													
		1809-R	94	N/A	136	160	183	207	231	254	278	302	326	349	N/A	N/A
			<i>Replacement Upholstery Covers</i>													
																
		1810-G	Overall: 32"w 32"d 35"h			Arm: 24"h			COM: 4.75 yds.							
			Seat: 21"w 20"d 18"h			Weight: 115 lbs.			COL: n/a							
			COM	COL	1	2	3	4	5	6	7	8	9	10	L1	L2
			1866	N/A	2024	2154	2284	2413	2543	2673	2803	2933	3063	3193	N/A	N/A
			<i>Circular Metal Base / Tight Seat & Back / Removable Upholstery / 500 lb. Weight Capacity</i>													
		1810-SG	2049	N/A	2151	2281	2411	2540	2670	2800	2930	3060	3190	3320	N/A	N/A
			<i>Swivel Glider w/ Circular Metal Base / Tight Seat & Back / Removable Upholstery / 500 lb. Weight Capacity</i>													
		1810-GR	261	N/A	531	674	816	958	1100	1243	1385	1527	1669	1812	N/A	N/A
			<i>Replacement Upholstery Covers</i>													
																
		<p>See Replay Healthcare Motion And Evolve Healthcare Motion For Additional Patient Chairs & Gliders.</p>														

DESCRIPTION:







- Upholstery Frames: Steel, Plywood & Hardwood
- Seat: High Density Polyurethane Foam Over Sheet Webbing
- Back: High Density Polyurethane Foam Over Sinuous Wire Springs
- Upholstered Covers: Attached w/ Velcro / Removable For Maintenance
- Antimicrobial Moisture Barrier Fully Encapsulates All Foam Areas
- Double Needle Stitching Standard (Wetling Optional - No Charge)
- Leather Upholstery Not Available
- Lifetime Warranty

OPTIONS:

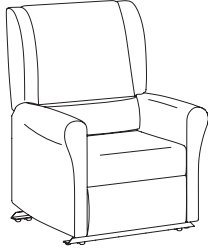
(See Facelift Revival Healthcare Options Pages)

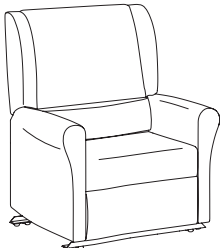
ER-1	Electric Recline	\$1054
BB	Battery Backup	\$548
HM	Heat & Massage	\$1498
H	Heat Only	\$1142

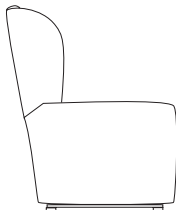
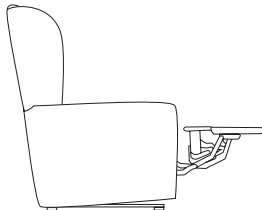
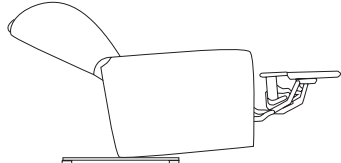
Feather Down & Polyester Pillows Available (See Page 5)
Specify Exposed Wood Finish (See Page 6)

WALLSAVER		ITEM #:	SPECIFICATIONS GRADES LIST PRICES:													
	WALLSAVER RECLINER / FULLY UPHOLSTERED		Overall: 31.5"w 34"d 42.25"h Seat: 21"w 21.75"d 18"h			Arm: 23"h Weight: 115 lbs.			COM: 6.25 yds. COL: n/a							
			COM	COL	1	2	3	4	5	6	7	8	9	10	L1	L2
	1811		2354	N/A	2627	2827	3028	3228	3429	3629	3829	4030	4230	4431	N/A	N/A
		<i>Tight Seat & Back / Removable Upholstery / Adjustable Semi-Attached Pillow-Lumbar / 6" Wall Proximity / 350 lb. Weight Capacity</i>														
	1811-R	294	N/A	657	847	1037	1226	1416	1606	1795	1985	2175	2364	N/A	N/A	
		<i>Replacement Upholstery Covers</i>														
																
	BARIATRIC WALLSAVER RECLINER / FULLY UPHOLSTERED		Overall: 36.5"w 34"d 42.25"h Seat: 26"w 21.75"d 18"h			Arm: 23"h Weight: 125 lbs.			COM: 6.75 yds. COL: n/a							
			COM	COL	1	2	3	4	5	6	7	8	9	10	L1	L2
	1811-X		2439	N/A	2740	2957	3175	3392	3609	3826	4043	4260	4477	4695	N/A	N/A
		<i>Tight Seat & Back / Removable Upholstery / Adjustable Semi-Attached Pillow-Lumbar / 6" Wall Proximity / 500 lb. Weight Capacity</i>														
	1811-XR	301	N/A	664	853	1043	1233	1422	1612	1802	1991	2181	2371	N/A	N/A	
		<i>Replacement Upholstery Covers</i>														
																
																
		Upright Position 34"D			Extended Footrest Position 57.5"D			Full Recline Position 67"D								
		 See Replay Healthcare Motion And Evolve Healthcare Motion For Additional WallSaver Recliners.														

DESCRIPTION:

- Upholstery Frames: Steel, Plywood & Hardwood
- Seat: High Density Polyurethane Foam Over Sheet Webbing
- Back: High Density Polyurethane Foam Over Sinuous Wire Springs
- Upholstered Covers: Attached w/ Velcro / Removable For Maintenance
- Antimicrobial Moisture Barrier Fully Encapsulates All Foam Areas
- Double Needle Stitching Standard (Wetling Optional - No Charge)
- Dual-Wheel Casters: (2) Front Locking/Swivel & (2) Rear Non-Locking/Non-Swivel (1514)
- (2) Drop Down Side Trays Mounted To Black Metal Tubing (1514)
- Exposed Wood Legs (1812): Solid Hardwood / Removable For Maintenance
- Leather Upholstery Not Available
- Lifetime Warranty

OPTIONS:

(See Facelift Revival Healthcare Options Pages)
 Feather Down & Polyester Pillows Available (See Page 5)

INFUSION / STAND-UP RECLINER

ITEM #:

SPECIFICATIONS | GRADES | LIST PRICES:

INFUSION WALLSAVER RECLINER / FULLY UPHOLSTERED



Optional Central Braking Available

Healthcare Motion

See Replay & Evolve Healthcare Motion For Additional Infusion Wallsaver Recliners.

Overall: 31.25"w 34"d 46"h **Arm:** 27"h **COM:** 6.5 yds.
Seat: 21"w 20.5"d 19"h **Weight:** 130 lbs. **COL:** n/a

COM	COL	1	2	3	4	5	6	7	8	9	10	L1	L2
1814	N/A	3335	3526	3717	3908	4099	4290	4480	4671	4862	5053	N/A	N/A
<i>Tight Seat & Back / Removable Upholstery / 350 lb. Weight Capacity</i>													
1814-R	N/A	638	804	969	1135	1301	1467	1633	1799	1965	2131	N/A	N/A
<i>Replacement Upholstery Covers</i>													

***NOTE: ELECTRIC OPTION NOT AVAILABLE ON INFUSION RECLINERS IN COMBINATION WITH CASTERS.**



Upright Position
32"D



Extended Footrest Position
52"D



Full Redine Position
64.5"D

ELECTRIC STAND-UP RECLINER / FULLY UPHOLSTERED

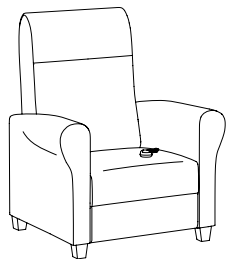

Healthcare Motion

See Replay Healthcare Motion For Additional Electric Stand-Up Recliner.

Overall: 35"w 35"d 42"h **Arm:** 24.5"h **COM:** 5.25 yds.
Seat: 21.5"w 21.75"d 18"h **Weight:** 145 lbs. **COL:** n/a

COM	COL	1	2	3	4	5	6	7	8	9	10	L1	L2
1812	N/A	3629	3796	3963	4131	4298	4465	4632	4799	4966	5133	N/A	N/A
<i>Tight Seat & Back / Removable Upholstery / 350 lb. Weight Capacity</i>													
1812-R	N/A	608	766	924	1082	1240	1398	1556	1714	1872	2030	N/A	N/A
<i>Replacement Upholstery Covers</i>													

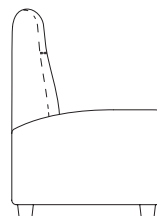

Upright Position
35"D

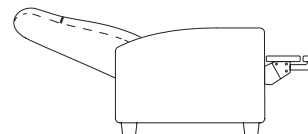

Full Recline Position
66"D

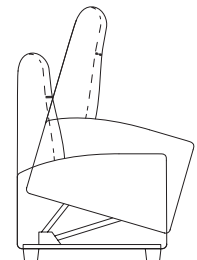

Stand-Up Position
59"H

DESCRIPTION:

- Upholstery Frames: Steel, Plywood & Hardwood
- Seat: High Density Polyurethane Foam Over Sheet Webbing
- Back: High Density Polyurethane Foam Over Sinuous Wire Springs
- Upholstered Covers: Attached w/ Velcro / Removable For Maintenance
- Antimicrobial Moisture Barrier Fully Encapsulates All Foam Areas
- Double Needle Stitching Standard (Welting Optional - No Charge)
- Rotational & Directional Locking Casters (Rear)
- Leather Upholstery Not Available
- Lifetime Warranty

OPTIONS:

Layflat Medical Recliner Options (See Revival Healthcare Options Pages)
 Feather Down & Polyester Pillows Available (See Page 5)

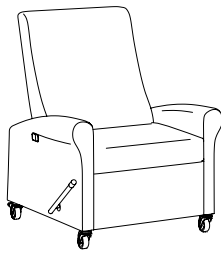
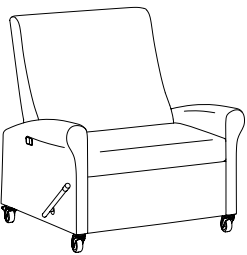
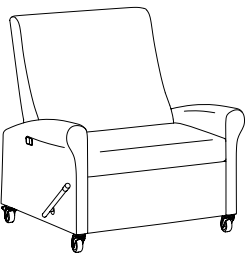
LAYFLAT MEDICAL RECLINER		ITEM #:	SPECIFICATIONS GRADES LIST PRICES:														
		LAYFLAT / TRENDELENBURG RECLINER	Overall: 35"w 38.5"d 45"h Seat: 24"w 20"d 20"h		Arm: 28"h Weight: 160 lbs.				COM: 5.5 yds. COL: n/a								
			COM	COL	1	2	3	4	5	6	7	8	9	10	L1	L2	
			1813-L	3669	N/A	3819	3995	4170	4346	4521	4696	4872	5047	5223	5398	N/A	N/A
			<i>Layflat / Tight Seat & Back / Removable Upholstery / 500 lb. Weight Capacity</i>														
		BARIATRIC LAYFLAT / TRENDELENBURG RECLINER	Overall: 40"w 38.5"d 45"h Seat: 29"w 20"d 20"h		Arm: 28"h Weight: 185 lbs.				COM: 6.25 yds. COL: n/a								
			COM	COL	1	2	3	4	5	6	7	8	9	10	L1	L2	
			1813-XL	3861	N/A	4051	4252	4452	4653	4853	5054	5254	5454	5655	5855	N/A	N/A
			<i>Layflat / Tight Seat & Back / Removable Upholstery / 600 lb. Weight Capacity</i>														
		1813-XT	<i>Trendelenburg / Tight Seat & Back / Removable Upholstery / 600 lb. Weight Capacity</i>														
			1813-XR	355	N/A	668	834	1000	1166	1332	1498	1664	1830	1996	2162	N/A	N/A
			<i>Replacement Upholstery Covers</i>														

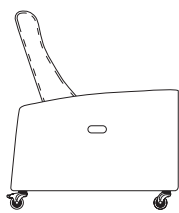

Upright Position
38.5"D

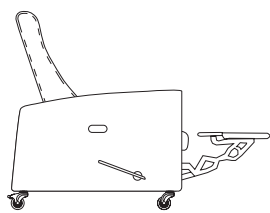

Extended Footrest Position
57.5"D

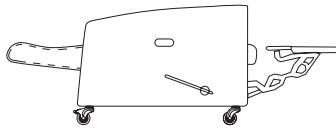



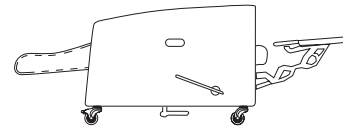

Layflat Position
73.75"D









Trendelenburg Position
74.75"D

 See *Replay Healthcare Motion (Page 176)*
 And *Evolve Healthcare Motion (Page 290)*
 For Additional Layflat Medical Recliners.

CASTERS / POWER	OPTION #:	SPECIFICATIONS LIST PRICES AVAILABILITY:
LOCKING / NON-LOCKING CASTERS		
<i>Overall: 1.875"w 2.25"d 1.5"h (Locking) / 1.875"w 1.625"d 1.5"h (Non-Locking)</i>		
 <p>Locking Casters</p>  <p>Non-Locking Casters</p>	LC	\$44 (Set Of Two) <i>Locking Casters (Black Finish / Specify Location)</i>
	NLC	\$37 (Set Of Two) <i>Non-Locking Casters (Black Finish / Specify Location)</i>
<i>Available: Facelift 2 Revival Sleepover Lounge</i>		
WALLSAVER - LOCKING / NON-LOCKING CASTERS		
<i>Overall: 2.5"w 4"d 3.5"h (Locking) / 2.5"w 3.25"d 3.5"h (Non-Locking)</i>		
 <p>Locking Casters</p>  <p>Non-Locking Casters</p>	WLC	\$199 List (Set Of Two) <i>Locking Swivel Casters (Gray Finish / Back Location)</i>
	WNLC	\$185 List (Set Of Two) <i>Non-Locking / Non-Swivel Casters (Gray Finish / Front Location)</i>
<i>Note: Wallsaver Locking / Non-Locking Casters Cannot Be Used In Combination With Electric Recline.</i>		
<i>Available: Facelift Wallsaver Recliners (1511 / 1811 / 1855 & Bariatric Versions)</i>		
MEDICAL LOCKING / NON-LOCKING CASTERS		
<i>Overall: 2.25"w 5"d 5.25"h (Locking) / 2"w 3.75"d 5.25"h (Non-Locking)</i>		
 <p>Locking Casters</p>  <p>Non-Locking Casters</p>	MLC	\$194 (Set Of Two) <i>Locking Casters - Motion & Direction (Gray Finish / Specify Location)</i>
	MNL	\$224 (Set Of Two) <i>Non-Locking Casters - Single Direction (Gray Finish / Specify Location)</i>
<i>Available: Facelift 2 Revival Electric Standup Recliner</i>		
POWER / DATA MODULE		
<i>PM1 Overall: 5.25"w 1.25"d 4.25"h PM2 Overall: 2"w 2"d .125"h USB-1 Overall: 2"w 2"d .125"h</i>		
 <p>PM1 Power / Data Module</p>  <p>PM2 Power Module</p>  <p>USB-1 Dual Charging USB</p>	PM1	\$859 Power/Data Module (1-Power / 1-USB 2 Port Simplex Charger Standard) <i>Vertical / Horizontal Mount Power Module. Price Varies By Socket. Contact Customer Service For Quote. (Additional Colors Available)</i>
	PM2	\$238 Power Module (1-Power) <i>Spill-Proof Technology / Multiple Finish Options / Storm Color Standard (Specify Left or Right Facing)</i>
	USB-1	\$238 Dual Charging USB (2 Port Simplex Charger Standard) <i>Spill-Proof Technology / 2 Amps Per Port / Multiple Finish Options / Storm Color Standard (Specify Left or Right Facing)</i>
<i>Available: Facelift Revival Healthcare Collection (1804, 1805, 1806, 1808)</i>		

BRAKE / LEGS / ELECTRIC / PUSH BAR	OPTION #:	SPECIFICATIONS LIST PRICES AVAILABILITY:
CENTRAL BRAKING		
<i>Overall: 7.5"w 2"d .5"h</i>		
	CB-1	\$508 (Set Of 1) <i>(Gray Plastic Brake w/ Lock & Unlock Pedals)</i> Available: <i>Facelift Revival Wallsaver & Infusion Wallsaver Recliners (1811, 1814)</i>
	CB-2	\$510 (Set Of 1) <i>(Gray Plastic Brake w/ Lock & Unlock Pedals)</i> Available: <i>Facelift Revival Layflat (1813 L/T)</i>
ALUMINUM ROUND LEGS		
<i>Overall: 2" Diameter 5"h</i>		
	ARL	\$353 (Set Of 4) <i>(Brushed Aluminum Finish)</i> Available: <i>Facelift 2 Revival Asynchronous Patient Chair (1808 Model)</i>
ELECTRIC RECLINE / BATTERY BACKUP / HEAT / MASSAGE		
<i>Overall: N/A</i>		
 <p>ER-1 Electric Recline (Wallsaver Model)</p> <p>ER-2/ER-3 Electric Recline (Layflat Model)</p> <p>HM Heat & Massage (All Recliner Models)</p> <p>H Heat (All Recliner Models)</p>	ER-1	\$1054 Electric Recline <i>Replaces Manual Mechanism On Any Wallsaver Model - Surface Mounts On Inside Arm (Specify Left Or Right Facing)</i> <i>*NOTE: ELECTRIC OPTION NOT AVAILABLE ON INFUSION RECLINERS IN COMBINATION WITH CASTERS.</i>
	ER-2	\$1087 Electric Recline <i>Replaces Manual Mechanism On Any Layflat Model - Surface Mounts On Inside Arm (Specify Left Or Right Facing)</i>
	ER-3	\$1149 Electric Recline <i>Replaces Manual Mechanism On Any Trendelenburg Layflat Model - Surface Mounts On Inside Arm (Specify Left Or Right Facing)</i>
	BB	\$548 Battery Backup <i>Allows Any Wallsaver, Layflat, Or Standup Electric Recliner To Be Cordless - Surface Mounts On Inside Arm (Specify Left Or Right Facing)</i>
	HM	\$1498 Heat & Massage <i>Add Heat & Massage To Any Wallsaver, Layflat, Or Standup Electric Recliner - Surface Mounts On Inside Arm (Specify Left Or Right Facing)</i>
H	\$1142 Heat <i>Add Heat Only To Any Wallsaver, Layflat, Or Standup Electric Recliner - Surface Mounts On Inside Arm (Specify Left Or Right Facing)</i> Available: <i>Facelift Revival Recliners</i>	
PUSH BAR		
<i>Overall: 18.5"w 3.5"d 1"h</i>		
	PB	\$267 <i>(Black Finish)</i> Available: <i>Facelift 2 Revival Medical Recliners</i>

I.V. / SIDE TRAY / BAG HOLDER / RESTRAINT BUCKLE / FOOTREST	OPTION #:	SPECIFICATIONS LIST PRICES AVAILABILITY:
<p>I.V. POLE</p> 	<p>IV</p>	<p>Overall: 10"w 2.5"d 39.5" / 69.75"h</p> <hr/> <p>\$489 <i>Height Adjustable I.V. Pole (Chrome & Black Finish / Specify Left Or Right Facing Location)</i></p> <p>Available: <i>Facelift 2 Revival Medical Recliners</i></p>
<p>SIDE TRAY</p>  	<p>ST-1 ST-2 WST</p>	<p>Overall: 12.75"w 10"d 4"h (Small Side Tray) / 17"w 10"d 4"h (Large Side Tray)</p> <hr/> <p>\$368 <i>Drop-Down Side Tray (Small Side Tray)</i></p> <p>\$415 <i>Drop-Down Side Tray (Large Side Tray)</i></p> <p>Available: <i>Facelift 2 Revival Medical Recliners</i> <i>Note: If A Medical Recliner With A Manual Mechanism Is Selected, The Standard Side Tray Location Will Be Front Right Facing</i></p> <p>\$598 <i>Drop-Down Side Tray (Large Side Tray) NOTE: Attaches To Metal Tubing</i></p> <p>Available: <i>Facelift Revival Wallsaver Recliners With Casters Option (1811)</i></p>
<p>BAG HOLDER / PERSONAL RESTRAINT BUCKLE</p> 	<p>BH RB</p>	<p>Overall: 2.19"w .38"d 2.56"h</p> <hr/> <p>\$86 <i>Bag Holder (Brushed Finish / Specify Left Or Right Facing Location)</i></p> <p>\$133 (Set Of 2) <i>Personal Restraint Buckle (Brushed Finish)</i></p> <p>Available: <i>Facelift 2 Revival Medical Recliners</i></p>
<p>FOOTREST</p> 	<p>FR</p>	<p>Overall: 16"w 8"d .1875"h</p> <hr/> <p>\$408 <i>(Black Finish)</i></p> <p>Available: <i>Facelift 2 Revival Medical Recliners</i></p>

OXYGEN TANK HOLDER / WOOD RING BASE / COVERS	OPTION #:	SPECIFICATIONS LIST PRICES AVAILABILITY:
<p>OXYGEN TANK HOLDER</p> 	<p>OH</p> <p>Overall: 4.75" Diameter 9.75"h</p> <p>\$247 <i>Black Metal Oxygen Tank Holder Holds a 4.375" Diameter Oxygen Tank (Not Included) (Specify Left Or Right Facing Location)</i></p> <p>Available: <i>Facelift 3 Revival Medical Recliners</i></p>	
<p>LOUNGE GLIDER WOOD RING BASE</p> 	<p>WR</p> <p>Overall: 22"dia. 3"h</p> <p>\$224 <i>Wood Ring Base replaces circular metal base (1810-G) or swivel glider w/ circular metal base (1810-SG).</i></p> <p><i>Specify Exposed Wood Finish. (See Page 6)</i></p> <p>Available: <i>Facelift Revival Lounge Glider</i></p>	
<p>CONTRASTING COVERS</p> 	<p>CC</p> <p>Overall: N/A</p> <p>\$129 <i>NOTE: If Two Or More Upholsteries Or Leathers Are Used On Any Piece Of Furniture, Then A Contrast Charge Will Apply Per Order. When Using Trinity Upholstery, The Higher Priced Upholstery Grade Will Be Used In Pricing, Unless It's Trinity Leather With Fabric Contrast Welt, Or COM With Trinity Contrast Welt, Then Contact Customer Service For Pricing.</i></p> <p>Available: <i>Facelift 2 Revival Healthcare Motion</i></p>	

Facelift Evolve

GUEST / TANDEM / TABLES

Effective: March 1, 2025

T R I N I T Y

Date:

Page:

Modification:

Description:

DESCRIPTION:

- Upholstery Frames: Steel, Plywood & Hardwood
- Seat: High Density Polyurethane Foam Over Strap Webbing
- Back: High Density Polyurethane Foam Over Plywood
- Upholstered Covers: Attached w/ Velcro / Removable For Maintenance
- Exposed Wood Legs: Solid Hardwood / Removable For Maintenance / Wallsaver Legs
- Antimicrobial Moisture Barrier Fully Encapsulates All Foam Areas
- Leather Upholstery Not Available
- Adjustable Height Leveling Glides Standard
- Lifetime Warranty

OPTIONS:

Closed Arm Panels (See 1800-PL / 1800-PR Item #'s)..... CALL FOR PRICING
Specify Exposed Wood Finish (See Page 6)

NOTE: All Seating Configurations Are Viewed From Left To Right Facing. Please Attach A Layout Showing Seating Configuration w/ Your Order. Assembled Units Must Be Shipped In Configurations Of 3 Or Less.

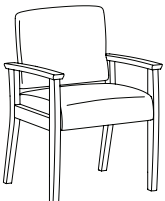
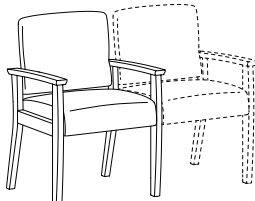
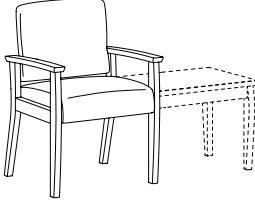
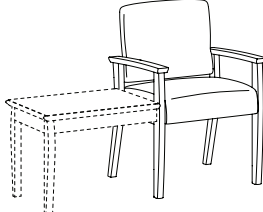
GUEST / TANDEM		ITEM #:	SPECIFICATIONS GRADES LIST PRICES:													
	ARM SIDE CHAIR / WOOD ARMS		Overall: 23.5"w 24"d 34"h Seat: 20"w 19"d 18.5"h		Arm: 25"h Weight: 45 lbs.		COM: 1.75 yds. COL: n/a									
			COM	COL	1	2	3	4	5	6	7	8	9	10	L1	L2
	1820		1220	N/A	1240	1283	1327	1370	1413	1457	1500	1543	1587	1630	N/A	N/A
		<i>Open Back / Tight Seat & Back / Removable Upholstery / 350 lb. Weight Capacity</i>														
	1820-R	150	N/A	237	284	332	379	426	474	521	569	616	664	N/A	N/A	
		<i>Replacement Upholstery Covers</i>														
	ARM CHAIR / WOOD ARMS / ACCEPTS SEAT ON RIGHT		Overall: 23.5"w 24"d 34"h Seat: 20"w 19"d 18.5"h		Arm: 25"h Weight: 45 lbs.		COM: 1.75 yds. COL: n/a									
			COM	COL	1	2	3	4	5	6	7	8	9	10	L1	L2
	1820-C		1220	N/A	1240	1283	1327	1370	1413	1457	1500	1543	1587	1630	N/A	N/A
		<i>Open Back / Tight Seat & Back / Removable Upholstery / 350 lb. Weight Capacity</i>														
	1820-R	150	N/A	237	284	332	379	426	474	521	569	616	664	N/A	N/A	
		<i>Replacement Upholstery Covers</i>														
	ARM CHAIR / WOOD ARMS / ACCEPTS TABLE ON RIGHT		Overall: 23.5"w 24"d 34"h Seat: 20"w 19"d 18.5"h		Arm: 25"h Weight: 45 lbs.		COM: 1.75 yds. COL: n/a									
			COM	COL	1	2	3	4	5	6	7	8	9	10	L1	L2
	1820-T		1220	N/A	1240	1283	1327	1370	1413	1457	1500	1543	1587	1630	N/A	N/A
		<i>Open Back / Tight Seat & Back / Removable Upholstery / 350 lb. Weight Capacity</i>														
	1820-R	150	N/A	237	284	332	379	426	474	521	569	616	664	N/A	N/A	
		<i>Replacement Upholstery Covers</i>														
	ARM CHAIR / WOOD ARMS / ACCEPTS TABLE ON LEFT		Overall: 23.5"w 24"d 34"h Seat: 20"w 19"d 18.5"h		Arm: 25"h Weight: 45 lbs.		COM: 1.75 yds. COL: n/a									
			COM	COL	1	2	3	4	5	6	7	8	9	10	L1	L2
	1820-LT		1220	N/A	1240	1283	1327	1370	1413	1457	1500	1543	1587	1630	N/A	N/A
		<i>Open Back / Tight Seat & Back / Removable Upholstery / 350 lb. Weight Capacity</i>														
	1820-R	150	N/A	237	284	332	379	426	474	521	569	616	664	N/A	N/A	
		<i>Replacement Upholstery Covers</i>														

DESCRIPTION:

- Upholstery Frames: Steel, Plywood & Hardwood
- Seat: High Density Polyurethane Foam Over Strap Webbing
- Back: High Density Polyurethane Foam Over Plywood
- Upholstered Covers: Attached w/ Velcro / Removable For Maintenance
- Exposed Wood Legs: Solid Hardwood / Removable For Maintenance / Wallsaver Legs
- Antimicrobial Moisture Barrier Fully Encapsulates All Foam Areas
- Leather Upholstery Not Available
- Adjustable Height Leveling Glides Standard
- Lifetime Warranty

OPTIONS:

Closed Arm Panels (See 1800-PL / 1800-PR Item #'s)..... CALL FOR PRICING
Specify Exposed Wood Finish (See Page 6)

NOTE: All Seating Configurations Are Viewed From Left To Right Facing. Please Attach A Layout Showing Seating Configuration w/ Your Order. Assembled Units Must Be Shipped In Configurations Of 3 Or Less.

TANDEM

ITEM #:

SPECIFICATIONS | GRADES | LIST PRICES:

ARM CHAIR / WOOD ARMS / ACCEPTS
TABLE ON LEFT / SEAT ON RIGHT

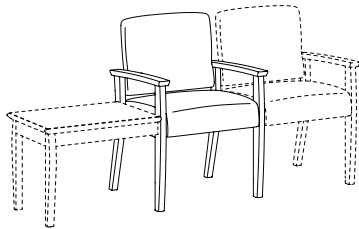

1820-TC

1820-R

Overall: 23.5"w 24"d 34"h
Seat: 20"w 19"d 18.5"h

Arm: 25"h
Weight: 45 lbs.

COM: 1.75 yds.
COL: n/a

COM	COL	1	2	3	4	5	6	7	8	9	10	L1	L2
1220	N/A	1240	1283	1327	1370	1413	1457	1500	1543	1587	1630	N/A	N/A
<i>Open Back / Tight Seat & Back / Removable Upholstery / 350 lb. Weight Capacity</i>													
150	N/A	237	284	332	379	426	474	521	569	616	664	N/A	N/A
<i>Replacement Upholstery Covers</i>													

ARM CHAIR / WOOD ARMS /
ACCEPTS TABLE ON LEFT / RIGHT

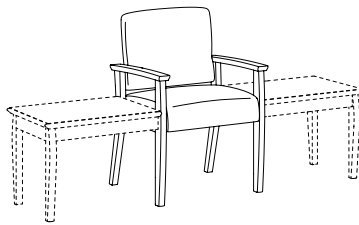

1820-TT

1820-R

Overall: 23.5"w 24"d 34"h
Seat: 20"w 19"d 18.5"h

Arm: 25"h
Weight: 45 lbs.

COM: 1.75 yds.
COL: n/a

COM	COL	1	2	3	4	5	6	7	8	9	10	L1	L2
1220	N/A	1240	1283	1327	1370	1413	1457	1500	1543	1587	1630	N/A	N/A
<i>Open Back / Tight Seat & Back / Removable Upholstery / 350 lb. Weight Capacity</i>													
150	N/A	237	284	332	379	426	474	521	569	616	664	N/A	N/A
<i>Replacement Upholstery Covers</i>													

DESCRIPTION:

- Upholstery Frames: Steel, Plywood & Hardwood
- Seat: High Density Polyurethane Foam Over Strap Webbing
- Back: High Density Polyurethane Foam Over Plywood
- Upholstered Covers: Attached w/ Velcro / Removable For Maintenance
- Exposed Wood Legs: Solid Hardwood / Removable For Maintenance / Wallsaver Legs
- Antimicrobial Moisture Barrier Fully Encapsulates All Foam Areas
- Leather Upholstery Not Available
- Adjustable Height Leveling Glides Standard
- Lifetime Warranty

OPTIONS:

Closed Arm Panels (See 1800-PL / 1800-PR Item #'s)..... CALL FOR PRICING
Specify Exposed Wood Finish (See Page 6)

NOTE: All Seating Configurations Are Viewed From Left To Right Facing. Please Attach A Layout Showing Seating Configuration w/ Your Order. Assembled Units Must Be Shipped In Configurations Of 3 Or Less.

TANDEM

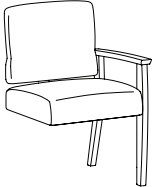
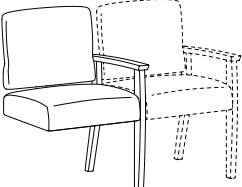
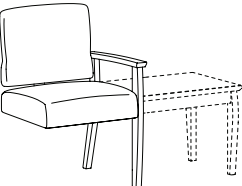
ITEM #:	SPECIFICATIONS GRADES LIST PRICES:													
ADD-A-SEAT / WOOD ARMS 	Overall: 21.75"w 24"d 34"h Seat: 20"w 19"d 18.5"h			Arm: 25"h Weight: 40 lbs.			COM: 1.75 yds. COL: n/a							
	COM	COL	1	2	3	4	5	6	7	8	9	10	L1	L2
	1821	970	N/A	1004	1047	1090	1133	1177	1220	1263	1307	1350	1393	N/A
	<i>Open Back / Tight Seat & Back / Removable Upholstery / 350 lb. Weight Capacity</i>													
1820-R	150	N/A	237	284	332	379	426	474	521	569	616	664	N/A	N/A
	<i>Replacement Upholstery Covers</i>													
ADD-A-SEAT / WOOD ARMS / ACCEPTS SEAT ON RIGHT 	Overall: 21.75"w 24"d 34"h Seat: 20"w 19"d 18.5"h			Arm: 25"h Weight: 40 lbs.			COM: 1.75 yds. COL: n/a							
	COM	COL	1	2	3	4	5	6	7	8	9	10	L1	L2
	1821-C	970	N/A	1004	1047	1090	1133	1177	1220	1263	1307	1350	1393	N/A
	<i>Open Back / Tight Seat & Back / Removable Upholstery / 350 lb. Weight Capacity</i>													
1820-R	150	N/A	237	284	332	379	426	474	521	569	616	664	N/A	N/A
	<i>Replacement Upholstery Covers</i>													
ADD-A-SEAT / WOOD ARMS / ACCEPTS TABLE ON RIGHT 	Overall: 21.75"w 24"d 34"h Seat: 20"w 19"d 18.5"h			Arm: 25"h Weight: 40 lbs.			COM: 1.75 yds. COL: n/a							
	COM	COL	1	2	3	4	5	6	7	8	9	10	L1	L2
	1821-T	970	N/A	1004	1047	1090	1133	1177	1220	1263	1307	1350	1393	N/A
	<i>Open Back / Tight Seat & Back / Removable Upholstery / 350 lb. Weight Capacity</i>													
1820-R	150	N/A	237	284	332	379	426	474	521	569	616	664	N/A	N/A
	<i>Replacement Upholstery Covers</i>													

DESCRIPTION:

- Upholstery Frames: Steel, Plywood & Hardwood
- Seat: High Density Polyurethane Foam Over Strap Webbing
- Back: High Density Polyurethane Foam Over Plywood
- Upholstered Covers: Attached w/ Velcro / Removable For Maintenance
- Exposed Wood Legs: Solid Hardwood / Removable For Maintenance / Wallsaver Legs
- Antimicrobial Moisture Barrier Fully Encapsulates All Foam Areas
- Leather Upholstery Not Available
- Adjustable Height Leveling Glides Standard
- Lifetime Warranty

OPTIONS:

- EPAC-1 Black Polyester Arm Caps (Set Of 2).....\$374
- Closed Arm Panels (See 1800-PL / 1800-PR Item #'s)..... CALL FOR PRICING

Specify Exposed Wood Finish (See Page 6)

NOTE: All Seating Configurations Are Viewed From Left To Right Facing. Please Attach A Layout Showing Seating Configuration w/ Your Order. Assembled Units Must Be Shipped In Configurations Of 3 Or Less.

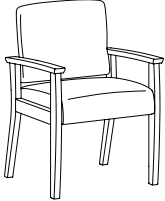
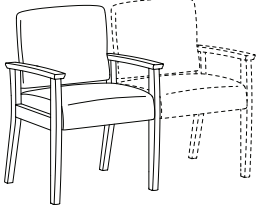
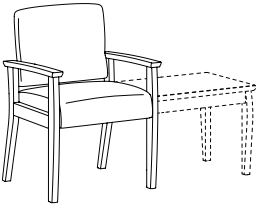
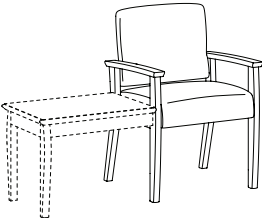
GUEST / TANDEM		ITEM #:	SPECIFICATIONS GRADES LIST PRICES:													
ARM SIDE CHAIR / URETHANE ARMS			Overall: 23.5"w 24"d 34"h			Arm: 25"h			COM: 1.75 yds.							
			Seat: 20"w 19"d 18.5"h			Weight: 45 lbs.			COL: n/a							
			COM	COL	1	2	3	4	5	6	7	8	9	10	L1	L2
	1822		1238	N/A	1269	1301	1344	1387	1431	1474	1517	1561	1604	1647	N/A	N/A
<i>Open Back / Tight Seat & Back / Removable Upholstery / 350 lb. Weight Capacity</i>																
	1820-R		150	N/A	237	284	332	379	426	474	521	569	616	664	N/A	N/A
<i>Replacement Upholstery Covers</i>																
ARM CHAIR / URETHANE ARMS / ACCEPTS SEAT ON RIGHT			Overall: 23.5"w 24"d 34"h			Arm: 25"h			COM: 1.75 yds.							
			Seat: 20"w 19"d 18.5"h			Weight: 45 lbs.			COL: n/a							
			COM	COL	1	2	3	4	5	6	7	8	9	10	L1	L2
	1822-C		1238	N/A	1269	1301	1344	1387	1431	1474	1517	1561	1604	1647	N/A	N/A
<i>Open Back / Tight Seat & Back / Removable Upholstery / 350 lb. Weight Capacity</i>																
	1820-R		150	N/A	237	284	332	379	426	474	521	569	616	664	N/A	N/A
<i>Replacement Upholstery Covers</i>																
ARM CHAIR / URETHANE ARMS / ACCEPTS TABLE ON RIGHT			Overall: 23.5"w 24"d 34"h			Arm: 25"h			COM: 1.75 yds.							
			Seat: 20"w 19"d 18.5"h			Weight: 45 lbs.			COL: n/a							
			COM	COL	1	2	3	4	5	6	7	8	9	10	L1	L2
	1822-T		1238	N/A	1269	1301	1344	1387	1431	1474	1517	1561	1604	1647	N/A	N/A
<i>Open Back / Tight Seat & Back / Removable Upholstery / 350 lb. Weight Capacity</i>																
	1820-R		150	N/A	237	284	332	379	426	474	521	569	616	664	N/A	N/A
<i>Replacement Upholstery Covers</i>																
ARM CHAIR / URETHANE ARMS / ACCEPTS TABLE ON LEFT			Overall: 23.5"w 24"d 34"h			Arm: 25"h			COM: 1.75 yds.							
			Seat: 20"w 19"d 18.5"h			Weight: 45 lbs.			COL: n/a							
			COM	COL	1	2	3	4	5	6	7	8	9	10	L1	L2
	1822-LT		1238	N/A	1269	1301	1344	1387	1431	1474	1517	1561	1604	1647	N/A	N/A
<i>Open Back / Tight Seat & Back / Removable Upholstery / 350 lb. Weight Capacity</i>																
	1820-R		150	N/A	237	284	332	379	426	474	521	569	616	664	N/A	N/A
<i>Replacement Upholstery Covers</i>																

DESCRIPTION:

- Upholstery Frames: Steel, Plywood & Hardwood
- Seat: High Density Polyurethane Foam Over Strap Webbing
- Back: High Density Polyurethane Foam Over Plywood
- Upholstered Covers: Attached w/ Velcro / Removable For Maintenance
- Exposed Wood Legs: Solid Hardwood / Removable For Maintenance / Wallsaver Legs
- Antimicrobial Moisture Barrier Fully Encapsulates All Foam Areas
- Leather Upholstery Not Available
- Adjustable Height Leveling Glides Standard
- Lifetime Warranty

OPTIONS:

- EPAC-1 Black Polyester Arm Caps (Set Of 2).....\$374
- Closed Arm Panels (See 1800-PL / 1800-PR Item #s)..... CALL FOR PRICING

Specify Exposed Wood Finish (See Page 6)

NOTE: All Seating Configurations Are Viewed From Left To Right Facing. Please Attach A Layout Showing Seating Configuration w/ Your Order. Assembled Units Must Be Shipped In Configurations Of 3 Or Less.

TANDEM

ITEM #:

SPECIFICATIONS | GRADES | LIST PRICES:

ARM CHAIR / URETHANE ARMS / ACCEPTS TABLE ON LEFT / SEAT ON RIGHT

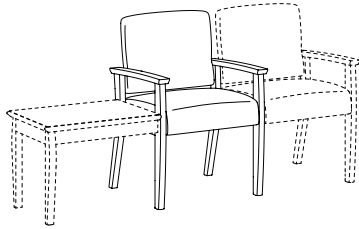

1822-TC

1820-R

Overall: 23.5"w 24"d 34"h		Arm: 25"h		COM: 1.75 yds.									
Seat: 20"w 19"d 18.5"h		Weight: 45 lbs.		COL: n/a									
COM	COL	1	2	3	4	5	6	7	8	9	10	L1	L2
1238	N/A	1269	1301	1344	1387	1431	1474	1517	1561	1604	1647	N/A	N/A
<i>Open Back / Tight Seat & Back / Removable Upholstery / 350 lb. Weight Capacity</i>													
150	N/A	237	284	332	379	426	474	521	569	616	664	N/A	N/A
<i>Replacement Upholstery Covers</i>													

ARM CHAIR / URETHANE ARMS / ACCEPTS TABLE ON LEFT / RIGHT

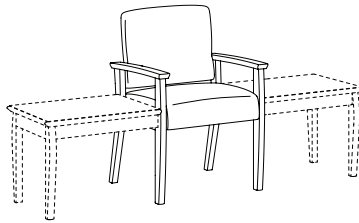

1822-TT

1820-R

Overall: 23.5"w 24"d 34"h		Arm: 25"h		COM: 1.75 yds.									
Seat: 20"w 19"d 18.5"h		Weight: 45 lbs.		COL: n/a									
COM	COL	1	2	3	4	5	6	7	8	9	10	L1	L2
1238	N/A	1269	1301	1344	1387	1431	1474	1517	1561	1604	1647	N/A	N/A
<i>Open Back / Tight Seat & Back / Removable Upholstery / 350 lb. Weight Capacity</i>													
150	N/A	237	284	332	379	426	474	521	569	616	664	N/A	N/A
<i>Replacement Upholstery Covers</i>													

DESCRIPTION:

- Upholstery Frames: Steel, Plywood & Hardwood
- Seat: High Density Polyurethane Foam Over Strap Webbing
- Back: High Density Polyurethane Foam Over Plywood
- Upholstered Covers: Attached w/ Velcro / Removable For Maintenance
- Exposed Wood Legs: Solid Hardwood / Removable For Maintenance / Wallsaver Legs
- Antimicrobial Moisture Barrier Fully Encapsulates All Foam Areas
- Leather Upholstery Not Available
- Adjustable Height Leveling Glides Standard
- Lifetime Warranty

OPTIONS:

- EPAC-1 Black Polyester Arm Caps (Set Of 2).....\$374
- Closed Arm Panels (See 1800-PL / 1800-PR Item #s)..... CALL FOR PRICING

Specify Exposed Wood Finish (See Page 6)

NOTE: All Seating Configurations Are Viewed From Left To Right Facing. Please Attach A Layout Showing Seating Configuration w/ Your Order. Assembled Units Must Be Shipped In Configurations Of 3 Or Less.

TANDEM

ITEM #: SPECIFICATIONS | GRADES | LIST PRICES:

ADD-A-SEAT / URETHANE ARMS

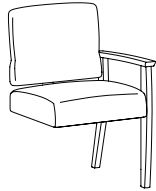

		Overall: 21.75"w 24"d 34"h		Arm: 25"h		COM: 1.75 yds.								
		Seat: 20"w 19"d 18.5"h		Weight: 40 lbs.		COL: n/a								
COM	COL	1	2	3	4	5	6	7	8	9	10	L1	L2	
1823	976	N/A	1009	1053	1096	1139	1182	1226	1269	1312	1356	1399	N/A	N/A
<i>Open Back / Tight Seat & Back / Removable Upholstery / 350 lb. Weight Capacity</i>														
1820-R	150	N/A	237	284	332	379	426	474	521	569	616	664	N/A	N/A
<i>Replacement Upholstery Covers</i>														

ADD-A-SEAT / URETHANE ARMS / ACCEPTS SEAT ON RIGHT

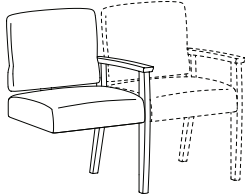

		Overall: 21.75"w 24"d 34"h		Arm: 25"h		COM: 1.75 yds.								
		Seat: 20"w 19"d 18.5"h		Weight: 40 lbs.		COL: n/a								
COM	COL	1	2	3	4	5	6	7	8	9	10	L1	L2	
1823-C	976	N/A	1009	1053	1096	1139	1182	1226	1269	1312	1356	1399	N/A	N/A
<i>Open Back / Tight Seat & Back / Removable Upholstery / 350 lb. Weight Capacity</i>														
1820-R	150	N/A	237	284	332	379	426	474	521	569	616	664	N/A	N/A
<i>Replacement Upholstery Covers</i>														

ADD-A-SEAT / URETHANE ARMS / ACCEPTS TABLE ON RIGHT

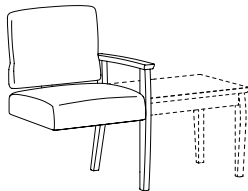

		Overall: 21.75"w 24"d 34"h		Arm: 25"h		COM: 1.75 yds.								
		Seat: 20"w 19"d 18.5"h		Weight: 40 lbs.		COL: n/a								
COM	COL	1	2	3	4	5	6	7	8	9	10	L1	L2	
1823-T	976	N/A	1009	1053	1096	1139	1182	1226	1269	1312	1356	1399	N/A	N/A
<i>Open Back / Tight Seat & Back / Removable Upholstery / 350 lb. Weight Capacity</i>														
1820-R	150	N/A	237	284	332	379	426	474	521	569	616	664	N/A	N/A
<i>Replacement Upholstery Covers</i>														

DESCRIPTION:

- Upholstery Frames: Steel, Plywood & Hardwood
- Seat: High Density Polyurethane Foam Over Strap Webbing
- Back: High Density Polyurethane Foam Over Plywood
- Upholstered Covers: Attached w/ Velcro / Removable For Maintenance
- Exposed Wood Legs: Solid Hardwood / Removable For Maintenance / Wallsaver Legs
- Antimicrobial Moisture Barrier Fully Encapsulates All Foam Areas
- Leather Upholstery Not Available
- Adjustable Height Leveling Glides Standard
- Lifetime Warranty

OPTIONS:

Closed Arm Panels (See 1800-PL / 1800-PR Item #'s)..... CALL FOR PRICING
Specify Exposed Wood Finish (See Page 6)

NOTE: All Seating Configurations Are Viewed From Left To Right Facing. Please Attach A Layout Showing Seating Configuration w/ Your Order. Assembled Units Must Be Shipped In Configurations Of 3 Or Less.

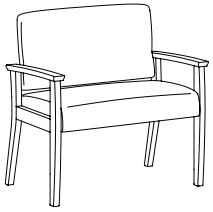
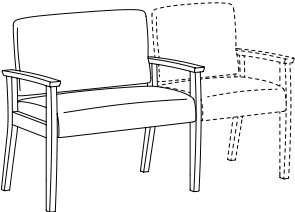
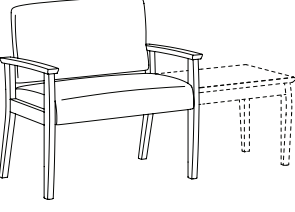
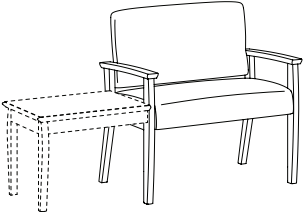
BARIATRIC / TANDEM		ITEM #:	SPECIFICATIONS GRADES LIST PRICES:													
BARIATRIC CHAIR / WOOD ARMS			<i>Overall: 33.5"w 24"d 34"h</i>			<i>Arm: 25"h</i>			<i>COM: 2.25 yds.</i>							
			<i>Seat: 30"w 19"d 18.5"h</i>			<i>Weight: 55 lbs.</i>			<i>COL: n/a</i>							
			COM	COL	1	2	3	4	5	6	7	8	9	10	L1	L2
	1830		1585	N/A	1614	1671	1729	1787	1845	1902	1960	2018	2076	2133	N/A	N/A
<i>Open Back / Tight Seat & Back / Removable Upholstery / 500 lb. Weight Capacity</i>																
	1830-R		161	N/A	279	342	405	468	531	595	658	721	784	848	N/A	N/A
<i>Replacement Upholstery Covers</i>																
BARIATRIC CHAIR / WOOD ARMS / ACCEPTS SEAT ON RIGHT			<i>Overall: 33.5"w 24"d 34"h</i>			<i>Arm: 25"h</i>			<i>COM: 2.25 yds.</i>							
			<i>Seat: 30"w 19"d 18.5"h</i>			<i>Weight: 55 lbs.</i>			<i>COL: n/a</i>							
			COM	COL	1	2	3	4	5	6	7	8	9	10	L1	L2
	1830-C		1585	N/A	1614	1671	1729	1787	1845	1902	1960	2018	2076	2133	N/A	N/A
<i>Open Back / Tight Seat & Back / Removable Upholstery / 500 lb. Weight Capacity</i>																
	1830-R		161	N/A	279	342	405	468	531	595	658	721	784	848	N/A	N/A
<i>Replacement Upholstery Covers</i>																
BARIATRIC CHAIR / WOOD ARMS / ACCEPTS TABLE ON RIGHT			<i>Overall: 33.5"w 24"d 34"h</i>			<i>Arm: 25"h</i>			<i>COM: 2.25 yds.</i>							
			<i>Seat: 30"w 19"d 18.5"h</i>			<i>Weight: 55 lbs.</i>			<i>COL: n/a</i>							
			COM	COL	1	2	3	4	5	6	7	8	9	10	L1	L2
	1830-T		1585	N/A	1614	1671	1729	1787	1845	1902	1960	2018	2076	2133	N/A	N/A
<i>Open Back / Tight Seat & Back / Removable Upholstery / 500 lb. Weight Capacity</i>																
	1830-R		161	N/A	279	342	405	468	531	595	658	721	784	848	N/A	N/A
<i>Replacement Upholstery Covers</i>																
BARIATRIC CHAIR / WOOD ARMS / ACCEPTS TABLE ON LEFT			<i>Overall: 33.5"w 24"d 34"h</i>			<i>Arm: 25"h</i>			<i>COM: 2.25 yds.</i>							
			<i>Seat: 30"w 19"d 18.5"h</i>			<i>Weight: 55 lbs.</i>			<i>COL: n/a</i>							
			COM	COL	1	2	3	4	5	6	7	8	9	10	L1	L2
	1830-LT		1585	N/A	1614	1671	1729	1787	1845	1902	1960	2018	2076	2133	N/A	N/A
<i>Open Back / Tight Seat & Back / Removable Upholstery / 500 lb. Weight Capacity</i>																
	1830-R		161	N/A	279	342	405	468	531	595	658	721	784	848	N/A	N/A
<i>Replacement Upholstery Covers</i>																

DESCRIPTION:

- Upholstery Frames: Steel, Plywood & Hardwood
- Seat: High Density Polyurethane Foam Over Strap Webbing
- Back: High Density Polyurethane Foam Over Plywood
- Upholstered Covers: Attached w/ Velcro / Removable For Maintenance
- Exposed Wood Legs: Solid Hardwood / Removable For Maintenance / Wallsaver Legs
- Antimicrobial Moisture Barrier Fully Encapsulates All Foam Areas
- Leather Upholstery Not Available
- Adjustable Height Leveling Glides Standard
- Lifetime Warranty

OPTIONS:

Closed Arm Panels (See 1800-PL / 1800-PR Item #'s)..... CALL FOR PRICING
Specify Exposed Wood Finish (See Page 6)

NOTE: All Seating Configurations Are Viewed From Left To Right Facing. Please Attach A Layout Showing Seating Configuration w/ Your Order. Assembled Units Must Be Shipped In Configurations Of 3 Or Less.

BARIATRIC / TANDEM

ITEM #:

SPECIFICATIONS | GRADES | LIST PRICES:

BARIATRIC CHAIR / WOOD ARMS / ACCEPTS TABLE ON LEFT / SEAT ON RIGHT

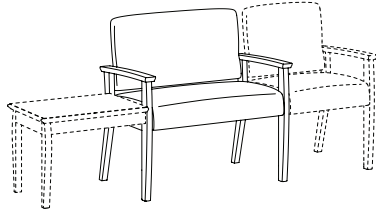

1830-TC

1830-R

Overall: 33.5"w 24"d 34"h		Arm: 25"h		COM: 2.25 yds.									
Seat: 30"w 19"d 18.5"h		Weight: 55 lbs.		COL: n/a									
COM	COL	1	2	3	4	5	6	7	8	9	10	L1	L2
1585	N/A	1614	1671	1729	1787	1845	1902	1960	2018	2076	2133	N/A	N/A
<i>Open Back / Tight Seat & Back / Removable Upholstery / 500 lb. Weight Capacity</i>													
161	N/A	279	342	405	468	531	595	658	721	784	848	N/A	N/A
<i>Replacement Upholstery Covers</i>													

BARIATRIC CHAIR / WOOD ARMS / ACCEPTS TABLE ON LEFT / RIGHT

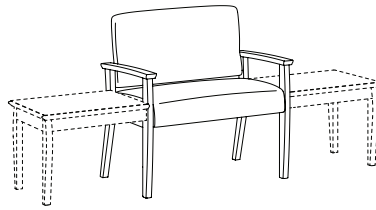

1830-TT

1830-R

Overall: 33.5"w 24"d 34"h		Arm: 25"h		COM: 2.25 yds.									
Seat: 30"w 19"d 18.5"h		Weight: 55 lbs.		COL: n/a									
COM	COL	1	2	3	4	5	6	7	8	9	10	L1	L2
1585	N/A	1614	1671	1729	1787	1845	1902	1960	2018	2076	2133	N/A	N/A
<i>Open Back / Tight Seat & Back / Removable Upholstery / 500 lb. Weight Capacity</i>													
161	N/A	279	342	405	468	531	595	658	721	784	848	N/A	N/A
<i>Replacement Upholstery Covers</i>													

DESCRIPTION:

- Upholstery Frames: Steel, Plywood & Hardwood
- Seat: High Density Polyurethane Foam Over Strap Webbing
- Back: High Density Polyurethane Foam Over Plywood
- Upholstered Covers: Attached w/ Velcro / Removable For Maintenance
- Exposed Wood Legs: Solid Hardwood / Removable For Maintenance / Wallsaver Legs
- Antimicrobial Moisture Barrier Fully Encapsulates All Foam Areas
- Leather Upholstery Not Available
- Adjustable Height Leveling Glides Standard
- Lifetime Warranty

OPTIONS:

Closed Arm Panels (See 1800-PL / 1800-PR Item #'s)..... CALL FOR PRICING
Specify Exposed Wood Finish (See Page 6)

NOTE: All Seating Configurations Are Viewed From Left To Right Facing. Please Attach A Layout Showing Seating Configuration w/ Your Order. Assembled Units Must Be Shipped In Configurations Of 3 Or Less.

BARIATRIC / TANDEM

ITEM #:

SPECIFICATIONS | GRADES | LIST PRICES:

BARIATRIC ADD-A-SEAT / WOOD ARMS

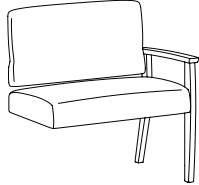

Overall: 31.75"w 24"d 34"h **Arm:** 25"h **COM:** 2.25 yds.
Seat: 30"w 19"d 18.5"h **Weight:** 52 lbs. **COL:** n/a

COM	COL	1	2	3	4	5	6	7	8	9	10	L1	L2
1831	N/A	1365	1423	1481	1538	1596	1654	1712	1769	1827	1885	N/A	N/A
<i>Open Back / Tight Seat & Back / Removable Upholstery / 500 lb. Weight Capacity</i>													
1830-R	N/A	279	342	405	468	531	595	658	721	784	848	N/A	N/A
<i>Replacement Upholstery Covers</i>													

BARIATRIC ADD-A-SEAT / WOOD ARMS / ACCEPTS SEAT ON RIGHT

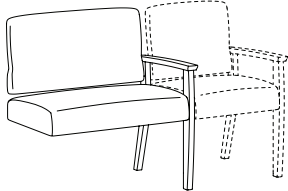

Overall: 31.75"w 24"d 34"h **Arm:** 25"h **COM:** 2.25 yds.
Seat: 30"w 19"d 18.5"h **Weight:** 52 lbs. **COL:** n/a

COM	COL	1	2	3	4	5	6	7	8	9	10	L1	L2
1831-C	N/A	1365	1423	1481	1538	1596	1654	1712	1769	1827	1885	N/A	N/A
<i>Open Back / Tight Seat & Back / Removable Upholstery / 500 lb. Weight Capacity</i>													
1830-R	N/A	279	342	405	468	531	595	658	721	784	848	N/A	N/A
<i>Replacement Upholstery Covers</i>													

BARIATRIC ADD-A-SEAT / WOOD ARMS / ACCEPTS TABLE ON RIGHT

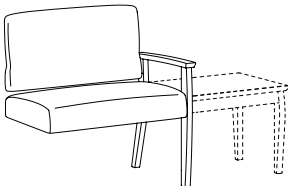

Overall: 31.75"w 24"d 34"h **Arm:** 25"h **COM:** 2.25 yds.
Seat: 30"w 19"d 18.5"h **Weight:** 52 lbs. **COL:** n/a

COM	COL	1	2	3	4	5	6	7	8	9	10	L1	L2
1831-T	N/A	1365	1423	1481	1538	1596	1654	1712	1769	1827	1885	N/A	N/A
<i>Open Back / Tight Seat & Back / Removable Upholstery / 500 lb. Weight Capacity</i>													
1830-R	N/A	279	342	405	468	531	595	658	721	784	848	N/A	N/A
<i>Replacement Upholstery Covers</i>													

DESCRIPTION:

- Upholstery Frames: Steel, Plywood & Hardwood
- Seat: High Density Polyurethane Foam Over Strap Webbing
- Back: High Density Polyurethane Foam Over Plywood
- Upholstered Covers: Attached w/ Velcro / Removable For Maintenance
- Exposed Wood Legs: Solid Hardwood / Removable For Maintenance / Wallsaver Legs
- Antimicrobial Moisture Barrier Fully Encapsulates All Foam Areas
- Leather Upholstery Not Available
- Adjustable Height Leveling Glides Standard
- Lifetime Warranty

OPTIONS:

- EPAC-1 Black Polyester Arm Caps (Set Of 2).....\$374
- Closed Arm Panels (See 1800-PL / 1800-PR Item #s)..... CALL FOR PRICING

Specify Exposed Wood Finish (See Page 6)

NOTE: All Seating Configurations Are Viewed From Left To Right Facing. Please Attach A Layout Showing Seating Configuration w/ Your Order. Assembled Units Must Be Shipped In Configurations Of 3 Or Less.

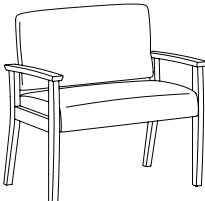
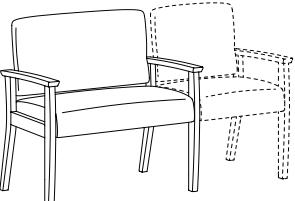
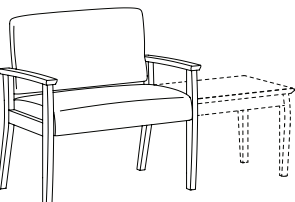
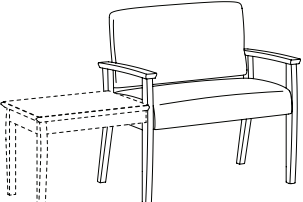
BARIATRIC / TANDEM		ITEM #:	SPECIFICATIONS GRADES LIST PRICES:													
		1832	Overall: 33.5"w 24"d 34"h		Arm: 25"h		COM: 2.25 yds.									
			Seat: 30"w 19"d 18.5"h		Weight: 55 lbs.		COL: n/a									
			COM	COL	1	2	3	4	5	6	7	8	9	10	L1	L2
			1597	N/A	1625	1683	1741	1798	1856	1914	1972	2029	2087	2145	N/A	N/A
			<i>Open Back / Tight Seat & Back / Removable Upholstery / 500 lb. Weight Capacity</i>													
		1830-R	161	N/A	279	342	405	468	531	595	658	721	784	848	N/A	N/A
			<i>Replacement Upholstery Covers</i>													
		1832-C	Overall: 33.5"w 24"d 34"h		Arm: 25"h		COM: 2.25 yds.									
			Seat: 30"w 19"d 18.5"h		Weight: 55 lbs.		COL: n/a									
			COM	COL	1	2	3	4	5	6	7	8	9	10	L1	L2
			1597	N/A	1625	1683	1741	1798	1856	1914	1972	2029	2087	2145	N/A	N/A
			<i>Open Back / Tight Seat & Back / Removable Upholstery / 500 lb. Weight Capacity</i>													
		1830-R	161	N/A	279	342	405	468	531	595	658	721	784	848	N/A	N/A
			<i>Replacement Upholstery Covers</i>													
		1832-T	Overall: 33.5"w 24"d 34"h		Arm: 25"h		COM: 2.25 yds.									
			Seat: 30"w 19"d 18.5"h		Weight: 55 lbs.		COL: n/a									
			COM	COL	1	2	3	4	5	6	7	8	9	10	L1	L2
			1597	N/A	1625	1683	1741	1798	1856	1914	1972	2029	2087	2145	N/A	N/A
			<i>Open Back / Tight Seat & Back / Removable Upholstery / 500 lb. Weight Capacity</i>													
		1830-R	161	N/A	279	342	405	468	531	595	658	721	784	848	N/A	N/A
			<i>Replacement Upholstery Covers</i>													
		1832-LT	Overall: 33.5"w 24"d 34"h		Arm: 25"h		COM: 2.25 yds.									
			Seat: 30"w 19"d 18.5"h		Weight: 55 lbs.		COL: n/a									
			COM	COL	1	2	3	4	5	6	7	8	9	10	L1	L2
			1597	N/A	1625	1683	1741	1798	1856	1914	1972	2029	2087	2145	N/A	N/A
			<i>Open Back / Tight Seat & Back / Removable Upholstery / 500 lb. Weight Capacity</i>													
		1830-R	161	N/A	279	342	405	468	531	595	658	721	784	848	N/A	N/A
			<i>Replacement Upholstery Covers</i>													

DESCRIPTION:

- Upholstery Frames: Steel, Plywood & Hardwood
- Seat: High Density Polyurethane Foam Over Strap Webbing
- Back: High Density Polyurethane Foam Over Plywood
- Upholstered Covers: Attached w/ Velcro / Removable For Maintenance
- Exposed Wood Legs: Solid Hardwood / Removable For Maintenance / Wallsaver Legs
- Antimicrobial Moisture Barrier Fully Encapsulates All Foam Areas
- Leather Upholstery Not Available
- Adjustable Height Leveling Glides Standard
- Lifetime Warranty

OPTIONS:

- EPAC-1 Black Polyester Arm Caps (Set Of 2).....\$374
- Closed Arm Panels (See 1800-PL / 1800-PR Item #s)..... CALL FOR PRICING

Specify Exposed Wood Finish (See Page 6)

NOTE: All Seating Configurations Are Viewed From Left To Right Facing. Please Attach A Layout Showing Seating Configuration w/ Your Order. Assembled Units Must Be Shipped In Configurations Of 3 Or Less.

BARIATRIC / TANDEM

ITEM #:

SPECIFICATIONS | GRADES | LIST PRICES:

BARIATRIC CHAIR / URETHANE ARMS / ACCEPTS TABLE ON LEFT / SEAT ON RIGHT

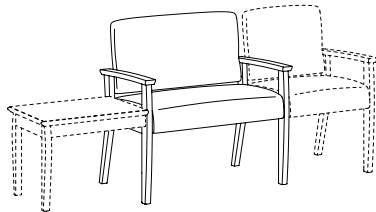

1832-TC

1830-R

			<i>Overall: 33.5"w 24"d 34"h</i>		<i>Arm: 25"h</i>		<i>COM: 2.25 yds.</i>							
			<i>Seat: 30"w 19"d 18.5"h</i>		<i>Weight: 55 lbs.</i>		<i>COL: n/a</i>							
COM	COL		1	2	3	4	5	6	7	8	9	10	L1	L2
1597	N/A		1625	1683	1741	1798	1856	1914	1972	2029	2087	2145	N/A	N/A
<i>Open Back / Tight Seat & Back / Removable Upholstery / 500 lb. Weight Capacity</i>														
161	N/A		279	342	405	468	531	595	658	721	784	848	N/A	N/A
<i>Replacement Upholstery Covers</i>														

BARIATRIC CHAIR / URETHANE ARMS / ACCEPTS TABLE ON LEFT / RIGHT

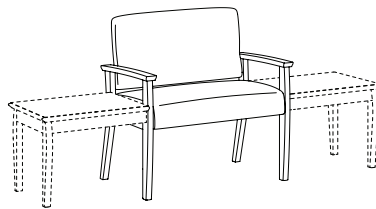

1832-TT

1830-R

			<i>Overall: 33.5"w 24"d 34"h</i>		<i>Arm: 25"h</i>		<i>COM: 2.25 yds.</i>							
			<i>Seat: 30"w 19"d 18.5"h</i>		<i>Weight: 55 lbs.</i>		<i>COL: n/a</i>							
COM	COL		1	2	3	4	5	6	7	8	9	10	L1	L2
1597	N/A		1625	1683	1741	1798	1856	1914	1972	2029	2087	2145	N/A	N/A
<i>Open Back / Tight Seat & Back / Removable Upholstery / 500 lb. Weight Capacity</i>														
161	N/A		279	342	405	468	531	595	658	721	784	848	N/A	N/A
<i>Replacement Upholstery Covers</i>														

DESCRIPTION:

- Upholstery Frames: Steel, Plywood & Hardwood
- Seat: High Density Polyurethane Foam Over Strap Webbing
- Back: High Density Polyurethane Foam Over Plywood
- Upholstered Covers: Attached w/ Velcro / Removable For Maintenance
- Exposed Wood Legs: Solid Hardwood / Removable For Maintenance / Wallsaver Legs
- Antimicrobial Moisture Barrier Fully Encapsulates All Foam Areas
- Leather Upholstery Not Available
- Adjustable Height Leveling Glides Standard
- Lifetime Warranty

OPTIONS:

- EPAC-1 Black Polyester Arm Caps (Set Of 2).....\$374
- Closed Arm Panels (See 1800-PL / 1800-PR Item #s)..... CALL FOR PRICING

Specify Exposed Wood Finish (See Page 6)

NOTE: All Seating Configurations Are Viewed From Left To Right Facing. Please Attach A Layout Showing Seating Configuration w/ Your Order. Assembled Units Must Be Shipped In Configurations Of 3 Or Less.

BARIATRIC / TANDEM

ITEM #:

SPECIFICATIONS | GRADES | LIST PRICES:

BARIATRIC ADD-A-SEAT / URETHANE ARMS

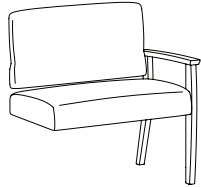

Overall: 31.75"w 24"d 34"h **Arm:** 25"h **COM:** 2.25 yds.
Seat: 30"w 19"d 18.5"h **Weight:** 52 lbs. **COL:** n/a

COM	COL	1	2	3	4	5	6	7	8	9	10	L1	L2
1833	N/A	1371	1429	1486	1544	1602	1660	1717	1775	1833	1890	N/A	N/A
<i>Open Back / Tight Seat & Back / Removable Upholstery / 500 lb. Weight Capacity</i>													
1830-R	N/A	279	342	405	468	531	595	658	721	784	848	N/A	N/A
<i>Replacement Upholstery Covers</i>													

BARIATRIC ADD-A-SEAT / URETHANE ARMS / ACCEPTS SEAT ON RIGHT

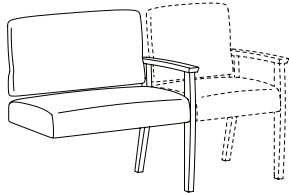

Overall: 31.75"w 24"d 34"h **Arm:** 25"h **COM:** 2.25 yds.
Seat: 30"w 19"d 18.5"h **Weight:** 52 lbs. **COL:** n/a

COM	COL	1	2	3	4	5	6	7	8	9	10	L1	L2
1833-C	N/A	1371	1429	1486	1544	1602	1660	1717	1775	1833	1890	N/A	N/A
<i>Open Back / Tight Seat & Back / Removable Upholstery / 500 lb. Weight Capacity</i>													
1830-R	N/A	279	342	405	468	531	595	658	721	784	848	N/A	N/A
<i>Replacement Upholstery Covers</i>													

BARIATRIC ADD-A-SEAT / URETHANE ARMS / ACCEPTS TABLE ON RIGHT

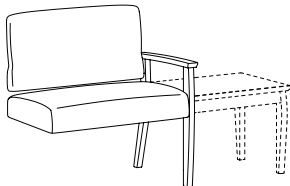

Overall: 31.75"w 24"d 34"h **Arm:** 25"h **COM:** 2.25 yds.
Seat: 30"w 19"d 18.5"h **Weight:** 52 lbs. **COL:** n/a

COM	COL	1	2	3	4	5	6	7	8	9	10	L1	L2
1833-T	N/A	1371	1429	1486	1544	1602	1660	1717	1775	1833	1890	N/A	N/A
<i>Open Back / Tight Seat & Back / Removable Upholstery / 500 lb. Weight Capacity</i>													
1830-R	N/A	279	342	405	468	531	595	658	721	784	848	N/A	N/A
<i>Replacement Upholstery Covers</i>													

DESCRIPTION:

- Upholstery Frames: Steel, Plywood & Hardwood
- Seat: High Density Polyurethane Foam Over Strap Webbing
- Back: High Density Polyurethane Foam Over Plywood
- Upholstered Covers: Attached w/ Velcro / Removable For Maintenance
- Exposed Wood Legs: Solid Hardwood / Removable For Maintenance / Wallsaver Legs
- Antimicrobial Moisture Barrier Fully Encapsulates All Foam Areas
- Leather Upholstery Not Available
- Adjustable Height Leveling Glides Standard
- Lifetime Warranty

OPTIONS:

Closed Arm Panels (See 1800-PL / 1800-PR Item #'s)..... CALL FOR PRICING
Specify Exposed Wood Finish (See Page 6)

NOTE: All Seating Configurations Are Viewed From Left To Right Facing. Please Attach A Layout Showing Seating Configuration w/ Your Order. Assembled Units Must Be Shipped In Configurations Of 3 Or Less.

TANDEM

ITEM #:

SPECIFICATIONS | GRADES | LIST PRICES:

TWO PLACE SOFA / WOOD ARMS

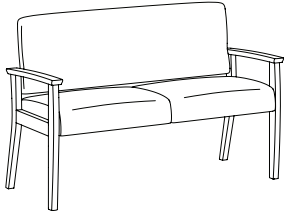

Overall: 51.5"w 24"d 34"h **Arm:** 25"h **COM:** 3.5 yds.
Seat: 48"w 19"d 18.5"h **Weight:** 65 lbs. **COL:** n/a

COM	COL	1	2	3	4	5	6	7	8	9	10	L1	L2
1848	N/A	2110	2204	2297	2391	2485	2579	2673	2766	2860	2954	N/A	N/A
<i>Open Back / Tight Seat & Back / Removable Upholstery / 750 lb. Weight Capacity</i>													
1848-R	N/A	416	519	621	724	827	930	1032	1135	1238	1341	N/A	N/A
<i>Replacement Upholstery Covers</i>													

TWO PLACE SOFA / WOOD ARMS / ACCEPTS SEAT ON RIGHT

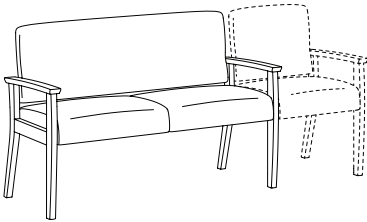

Overall: 51.5"w 24"d 34"h **Arm:** 25"h **COM:** 3.5 yds.
Seat: 48"w 19"d 18.5"h **Weight:** 65 lbs. **COL:** n/a

COM	COL	1	2	3	4	5	6	7	8	9	10	L1	L2
1848-C	N/A	2110	2204	2297	2391	2485	2579	2673	2766	2860	2954	N/A	N/A
<i>Open Back / Tight Seat & Back / Removable Upholstery / 750 lb. Weight Capacity</i>													
1848-R	N/A	416	519	621	724	827	930	1032	1135	1238	1341	N/A	N/A
<i>Replacement Upholstery Covers</i>													

TWO PLACE SOFA / WOOD ARMS / ACCEPTS TABLE ON RIGHT

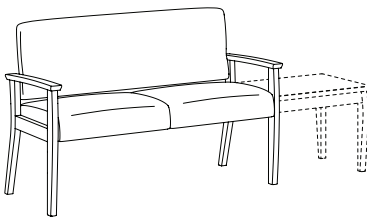

Overall: 51.5"w 24"d 34"h **Arm:** 25"h **COM:** 3.5 yds.
Seat: 48"w 19"d 18.5"h **Weight:** 65 lbs. **COL:** n/a

COM	COL	1	2	3	4	5	6	7	8	9	10	L1	L2
1848-T	N/A	2110	2204	2297	2391	2485	2579	2673	2766	2860	2954	N/A	N/A
<i>Open Back / Tight Seat & Back / Removable Upholstery / 750 lb. Weight Capacity</i>													
1848-R	N/A	416	519	621	724	827	930	1032	1135	1238	1341	N/A	N/A
<i>Replacement Upholstery Covers</i>													

TWO PLACE SOFA / WOOD ARMS / ACCEPTS TABLE ON LEFT

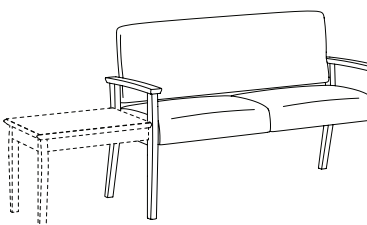

Overall: 51.5"w 24"d 34"h **Arm:** 25"h **COM:** 3.5 yds.
Seat: 48"w 19"d 18.5"h **Weight:** 65 lbs. **COL:** n/a

COM	COL	1	2	3	4	5	6	7	8	9	10	L1	L2
1848-LT	N/A	2110	2204	2297	2391	2485	2579	2673	2766	2860	2954	N/A	N/A
<i>Open Back / Tight Seat & Back / Removable Upholstery / 750 lb. Weight Capacity</i>													
1848-R	N/A	416	519	621	724	827	930	1032	1135	1238	1341	N/A	N/A
<i>Replacement Upholstery Covers</i>													

DESCRIPTION:

- Upholstery Frames: Steel, Plywood & Hardwood
- Seat: High Density Polyurethane Foam Over Strap Webbing
- Back: High Density Polyurethane Foam Over Plywood
- Upholstered Covers: Attached w/ Velcro / Removable For Maintenance
- Exposed Wood Legs: Solid Hardwood / Removable For Maintenance / Wallsaver Legs
- Antimicrobial Moisture Barrier Fully Encapsulates All Foam Areas
- Leather Upholstery Not Available
- Adjustable Height Leveling Glides Standard
- Lifetime Warranty

OPTIONS:

Closed Arm Panels (See 1800-PL / 1800-PR Item #'s)..... CALL FOR PRICING
Specify Exposed Wood Finish (See Page 6)

NOTE: All Seating Configurations Are Viewed From Left To Right Facing. Please Attach A Layout Showing Seating Configuration w/ Your Order. Assembled Units Must Be Shipped In Configurations Of 3 Or Less.

TANDEM

ITEM #:

SPECIFICATIONS | GRADES | LIST PRICES:

**TWO PLACE SOFA / WOOD ARMS /
ACCEPTS TABLE ON LEFT / SEAT ON RIGHT**

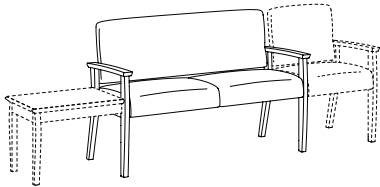

1848-TC

1848-R

Overall: 51.5"w 24"d 34"h
Seat: 48"w 19"d 18.5"h

Arm: 25"h
Weight: 65 lbs.

COM: 3.5 yds.
COL: n/a

COM	COL	1	2	3	4	5	6	7	8	9	10	L1	L2
2033	N/A	2110	2204	2297	2391	2485	2579	2673	2766	2860	2954	N/A	N/A
<i>Open Back / Tight Seat & Back / Removable Upholstery / 750 lb. Weight Capacity</i>													
223	N/A	416	519	621	724	827	930	1032	1135	1238	1341	N/A	N/A
<i>Replacement Upholstery Covers</i>													

**TWO PLACE SOFA / WOOD ARMS /
ACCEPTS TABLE ON LEFT / RIGHT**

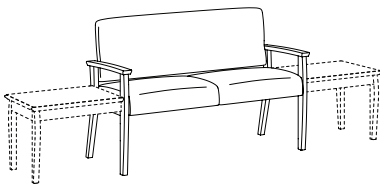

1848-TT

1848-R

Overall: 51.5"w 24"d 34"h
Seat: 48"w 19"d 18.5"h

Arm: 25"h
Weight: 65 lbs.

COM: 3.5 yds.
COL: n/a

COM	COL	1	2	3	4	5	6	7	8	9	10	L1	L2
2033	N/A	2110	2204	2297	2391	2485	2579	2673	2766	2860	2954	N/A	N/A
<i>Open Back / Tight Seat & Back / Removable Upholstery / 750 lb. Weight Capacity</i>													
223	N/A	416	519	621	724	827	930	1032	1135	1238	1341	N/A	N/A
<i>Replacement Upholstery Covers</i>													

DESCRIPTION:

- Upholstery Frames: Steel, Plywood & Hardwood
- Seat: High Density Polyurethane Foam Over Strap Webbing
- Back: High Density Polyurethane Foam Over Plywood
- Upholstered Covers: Attached w/ Velcro / Removable For Maintenance
- Exposed Wood Legs: Solid Hardwood / Removable For Maintenance / Wallsaver Legs
- Antimicrobial Moisture Barrier Fully Encapsulates All Foam Areas
- Leather Upholstery Not Available
- Adjustable Height Leveling Glides Standard
- Lifetime Warranty

OPTIONS:

Closed Arm Panels (See 1800-PL / 1800-PR Item #'s)..... CALL FOR PRICING
Specify Exposed Wood Finish (See Page 6)

NOTE: All Seating Configurations Are Viewed From Left To Right Facing. Please Attach A Layout Showing Seating Configuration w/ Your Order. Assembled Units Must Be Shipped In Configurations Of 3 Or Less.

TANDEM

ITEM #:

SPECIFICATIONS | GRADES | LIST PRICES:

TWO PLACE ADD-A-SEAT / WOOD ARMS

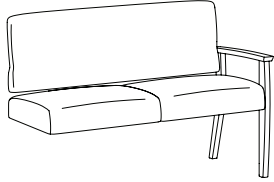

		Overall: 49.75"w 24"d 34"h		Arm: 25"h		COM: 3.5 yds.							
		Seat: 48"w 19"d 18.5"h		Weight: 62 lbs.		COL: n/a							
COM	COL	1	2	3	4	5	6	7	8	9	10	L1	L2
1849	N/A	1860	1953	2047	2141	2235	2329	2422	2516	2610	2704	N/A	N/A
<i>Open Back / Tight Seat & Back / Removable Upholstery / 750 lb. Weight Capacity</i>													
1848-R	N/A	416	519	621	724	827	930	1032	1135	1238	1341	N/A	N/A
<i>Replacement Upholstery Covers</i>													

TWO PLACE ADD-A-SEAT / WOOD ARMS / ACCEPTS SEAT ON RIGHT

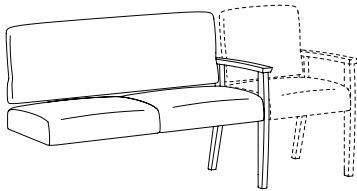

		Overall: 49.75"w 24"d 34"h		Arm: 25"h		COM: 3.5 yds.							
		Seat: 48"w 19"d 18.5"h		Weight: 62 lbs.		COL: n/a							
COM	COL	1	2	3	4	5	6	7	8	9	10	L1	L2
1849-C	N/A	1860	1953	2047	2141	2235	2329	2422	2516	2610	2704	N/A	N/A
<i>Open Back / Tight Seat & Back / Removable Upholstery / 750 lb. Weight Capacity</i>													
1848-R	N/A	416	519	621	724	827	930	1032	1135	1238	1341	N/A	N/A
<i>Replacement Upholstery Covers</i>													

TWO PLACE ADD-A-SEAT / WOOD ARMS / ACCEPTS TABLE ON RIGHT

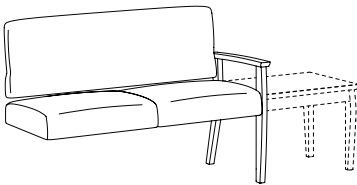

		Overall: 49.75"w 24"d 34"h		Arm: 25"h		COM: 3.5 yds.							
		Seat: 48"w 19"d 18.5"h		Weight: 62 lbs.		COL: n/a							
COM	COL	1	2	3	4	5	6	7	8	9	10	L1	L2
1849-T	N/A	1860	1953	2047	2141	2235	2329	2422	2516	2610	2704	N/A	N/A
<i>Open Back / Tight Seat & Back / Removable Upholstery / 750 lb. Weight Capacity</i>													
1848-R	N/A	416	519	621	724	827	930	1032	1135	1238	1341	N/A	N/A
<i>Replacement Upholstery Covers</i>													

DESCRIPTION:

- Upholstery Frames: Steel, Plywood & Hardwood
- Seat: High Density Polyurethane Foam Over Strap Webbing
- Back: High Density Polyurethane Foam Over Plywood
- Upholstered Covers: Attached w/ Velcro / Removable For Maintenance
- Exposed Wood Legs: Solid Hardwood / Removable For Maintenance / Wallsaver Legs
- Antimicrobial Moisture Barrier Fully Encapsulates All Foam Areas
- Leather Upholstery Not Available
- Adjustable Height Leveling Glides Standard
- Lifetime Warranty

OPTIONS:

- EPAC-1 Black Polyester Arm Caps (Set Of 2).....\$374
- Closed Arm Panels (See 1800-PL / 1800-PR Item #s)..... CALL FOR PRICING

Specify Exposed Wood Finish (See Page 6)

NOTE: All Seating Configurations Are Viewed From Left To Right Facing. Please Attach A Layout Showing Seating Configuration w/ Your Order. Assembled Units Must Be Shipped In Configurations Of 3 Or Less.

TANDEM

ITEM #: SPECIFICATIONS | GRADES | LIST PRICES:

TWO PLACE SOFA / URETHANE ARMS

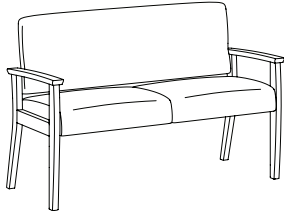

Overall: 51.5"w 24"d 34"h **Arm:** 25"h **COM:** 3.5 yds.
Seat: 48"w 19"d 18.5"h **Weight:** 65 lbs. **COL:** n/a

COM	COL	1	2	3	4	5	6	7	8	9	10	L1	L2
1850	N/A	2133	2227	2321	2414	2508	2602	2696	2790	2884	2977	N/A	N/A
<i>Open Back / Tight Seat & Back / Removable Upholstery / 750 lb. Weight Capacity</i>													
1848-R	N/A	416	519	621	724	827	930	1032	1135	1238	1341	N/A	N/A
<i>Replacement Upholstery Covers</i>													

TWO PLACE SOFA / URETHANE ARMS / ACCEPTS SEAT ON RIGHT

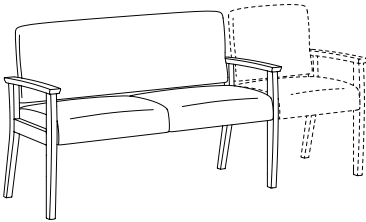

Overall: 51.5"w 24"d 34"h **Arm:** 25"h **COM:** 3.5 yds.
Seat: 48"w 19"d 18.5"h **Weight:** 65 lbs. **COL:** n/a

COM	COL	1	2	3	4	5	6	7	8	9	10	L1	L2
1850-C	N/A	2133	2227	2321	2414	2508	2602	2696	2790	2884	2977	N/A	N/A
<i>Open Back / Tight Seat & Back / Removable Upholstery / 750 lb. Weight Capacity</i>													
1848-R	N/A	416	519	621	724	827	930	1032	1135	1238	1341	N/A	N/A
<i>Replacement Upholstery Covers</i>													

TWO PLACE SOFA / URETHANE ARMS / ACCEPTS TABLE ON RIGHT

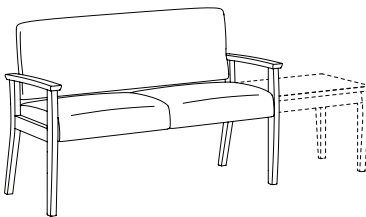

Overall: 51.5"w 24"d 34"h **Arm:** 25"h **COM:** 3.5 yds.
Seat: 48"w 19"d 18.5"h **Weight:** 65 lbs. **COL:** n/a

COM	COL	1	2	3	4	5	6	7	8	9	10	L1	L2
1850-T	N/A	2133	2227	2321	2414	2508	2602	2696	2790	2884	2977	N/A	N/A
<i>Open Back / Tight Seat & Back / Removable Upholstery / 750 lb. Weight Capacity</i>													
1848-R	N/A	416	519	621	724	827	930	1032	1135	1238	1341	N/A	N/A
<i>Replacement Upholstery Covers</i>													

TWO PLACE SOFA / URETHANE ARMS / ACCEPTS TABLE ON LEFT

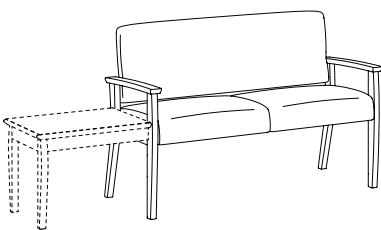

Overall: 51.5"w 24"d 34"h **Arm:** 25"h **COM:** 3.5 yds.
Seat: 48"w 19"d 18.5"h **Weight:** 65 lbs. **COL:** n/a

COM	COL	1	2	3	4	5	6	7	8	9	10	L1	L2
1850-LT	N/A	2133	2227	2321	2414	2508	2602	2696	2790	2884	2977	N/A	N/A
<i>Open Back / Tight Seat & Back / Removable Upholstery / 750 lb. Weight Capacity</i>													
1848-R	N/A	416	519	621	724	827	930	1032	1135	1238	1341	N/A	N/A
<i>Replacement Upholstery Covers</i>													

DESCRIPTION:

- Upholstery Frames: Steel, Plywood & Hardwood
- Seat: High Density Polyurethane Foam Over Strap Webbing
- Back: High Density Polyurethane Foam Over Plywood
- Upholstered Covers: Attached w/ Velcro / Removable For Maintenance
- Exposed Wood Legs: Solid Hardwood / Removable For Maintenance / Wallsaver Legs
- Antimicrobial Moisture Barrier Fully Encapsulates All Foam Areas
- Leather Upholstery Not Available
- Adjustable Height Leveling Glides Standard
- Lifetime Warranty

OPTIONS:

- EPAC-1 Black Polyester Arm Caps (Set Of 2).....\$374
- Closed Arm Panels (See 1800-PL / 1800-PR Item #s)..... CALL FOR PRICING

Specify Exposed Wood Finish (See Page 6)

NOTE: All Seating Configurations Are Viewed From Left To Right Facing. Please Attach A Layout Showing Seating Configuration w/ Your Order. Assembled Units Must Be Shipped In Configurations Of 3 Or Less.

TANDEM

ITEM #:

SPECIFICATIONS | GRADES | LIST PRICES:

TWO PLACE SOFA / URETHANE ARMS / ACCEPTS TABLE ON LEFT / SEAT ON RIGHT

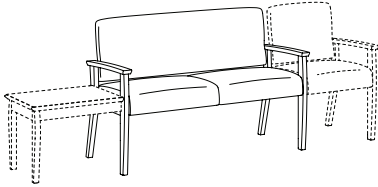

1850-TC

1848-R

			<i>Overall: 51.5"w 24"d 34"h</i>		<i>Arm: 25"h</i>		<i>COM: 3.5 yds.</i>							
			<i>Seat: 48"w 19"d 18.5"h</i>		<i>Weight: 65 lbs.</i>		<i>COL: n/a</i>							
COM	COL		1	2	3	4	5	6	7	8	9	10	L1	L2
2058	N/A		2133	2227	2321	2414	2508	2602	2696	2790	2884	2977	N/A	N/A
<i>Open Back / Tight Seat & Back / Removable Upholstery / 750 lb. Weight Capacity</i>														
223	N/A		416	519	621	724	827	930	1032	1135	1238	1341	N/A	N/A
<i>Replacement Upholstery Covers</i>														

TWO PLACE SOFA / URETHANE ARMS / ACCEPTS TABLE ON LEFT / RIGHT

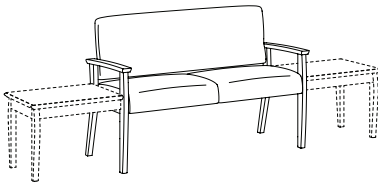

1850-TT

1848-R

			<i>Overall: 51.5"w 24"d 34"h</i>		<i>Arm: 25"h</i>		<i>COM: 3.5 yds.</i>							
			<i>Seat: 48"w 19"d 18.5"h</i>		<i>Weight: 65 lbs.</i>		<i>COL: n/a</i>							
COM	COL		1	2	3	4	5	6	7	8	9	10	L1	L2
2058	N/A		2133	2227	2321	2414	2508	2602	2696	2790	2884	2977	N/A	N/A
<i>Open Back / Tight Seat & Back / Removable Upholstery / 750 lb. Weight Capacity</i>														
223	N/A		416	519	621	724	827	930	1032	1135	1238	1341	N/A	N/A
<i>Replacement Upholstery Covers</i>														

DESCRIPTION:

- Upholstery Frames: Steel, Plywood & Hardwood
- Seat: High Density Polyurethane Foam Over Strap Webbing
- Back: High Density Polyurethane Foam Over Plywood
- Upholstered Covers: Attached w/ Velcro / Removable For Maintenance
- Exposed Wood Legs: Solid Hardwood / Removable For Maintenance / Wallsaver Legs
- Antimicrobial Moisture Barrier Fully Encapsulates All Foam Areas
- Leather Upholstery Not Available
- Adjustable Height Leveling Glides Standard
- Lifetime Warranty

OPTIONS:

- EPAC-1 Black Polyester Arm Caps (Set Of 2).....\$374
- Closed Arm Panels (See 1800-PL / 1800-PR Item #s)..... CALL FOR PRICING

Specify Exposed Wood Finish (See Page 6)

NOTE: All Seating Configurations Are Viewed From Left To Right Facing. Please Attach A Layout Showing Seating Configuration w/ Your Order. Assembled Units Must Be Shipped In Configurations Of 3 Or Less.

TANDEM

ITEM #: SPECIFICATIONS | GRADES | LIST PRICES:

TWO PLACE ADD-A-SEAT / URETHANE ARMS

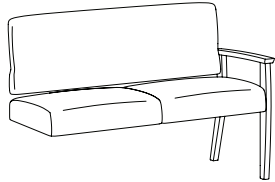

Overall: 49.75"w 24"d 34"h **Arm:** 25"h **COM:** 3.5 yds.
Seat: 48"w 19"d 18.5"h **Weight:** 62 lbs. **COL:** n/a

COM	COL	1	2	3	4	5	6	7	8	9	10	L1	L2
-----	-----	---	---	---	---	---	---	---	---	---	----	----	----

1851	1817	N/A	1906	2000	2093	2187	2281	2375	2469	2562	2656	2750	N/A	N/A
-------------	------	-----	------	------	------	------	------	------	------	------	------	------	-----	-----

Open Back / Tight Seat & Back / Removable Upholstery / 750 lb. Weight Capacity

1848-R	223	N/A	416	519	621	724	827	930	1032	1135	1238	1341	N/A	N/A
---------------	-----	-----	-----	-----	-----	-----	-----	-----	------	------	------	------	-----	-----

Replacement Upholstery Covers

TWO PLACE ADD-A-SEAT / URETHANE ARMS / ACCEPTS SEAT ON RIGHT

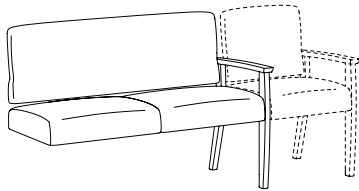

Overall: 49.75"w 24"d 34"h **Arm:** 25"h **COM:** 3.5 yds.
Seat: 48"w 19"d 18.5"h **Weight:** 62 lbs. **COL:** n/a

COM	COL	1	2	3	4	5	6	7	8	9	10	L1	L2
-----	-----	---	---	---	---	---	---	---	---	---	----	----	----

1851-C	1817	N/A	1906	2000	2093	2187	2281	2375	2469	2562	2656	2750	N/A	N/A
---------------	------	-----	------	------	------	------	------	------	------	------	------	------	-----	-----

Open Back / Tight Seat & Back / Removable Upholstery / 750 lb. Weight Capacity

1848-R	223	N/A	416	519	621	724	827	930	1032	1135	1238	1341	N/A	N/A
---------------	-----	-----	-----	-----	-----	-----	-----	-----	------	------	------	------	-----	-----

Replacement Upholstery Covers

TWO PLACE ADD-A-SEAT / URETHANE ARMS / ACCEPTS TABLE ON RIGHT

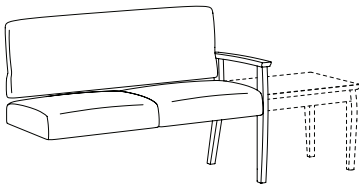

Overall: 49.75"w 24"d 34"h **Arm:** 25"h **COM:** 3.5 yds.
Seat: 48"w 19"d 18.5"h **Weight:** 62 lbs. **COL:** n/a

COM	COL	1	2	3	4	5	6	7	8	9	10	L1	L2
-----	-----	---	---	---	---	---	---	---	---	---	----	----	----

1851-T	1817	N/A	1906	2000	2093	2187	2281	2375	2469	2562	2656	2750	N/A	N/A
---------------	------	-----	------	------	------	------	------	------	------	------	------	------	-----	-----

Open Back / Tight Seat & Back / Removable Upholstery / 750 lb. Weight Capacity

1848-R	223	N/A	416	519	621	724	827	930	1032	1135	1238	1341	N/A	N/A
---------------	-----	-----	-----	-----	-----	-----	-----	-----	------	------	------	------	-----	-----

Replacement Upholstery Covers

DESCRIPTION:

- Edge Banding / Legs: Solid Maple
- Wilsonart Plastic Laminates Standard. Alternate Selections May Be Specified From Most Major Laminate Manufacturers. (Contact Factory For Availability)
- Metal Support Leg 1" - 16 Gauge Steel Leg w/ Adjustable Glide (Attaches Via 4.5" Mounting Plate) (#18SC2626 Only)
- Lifetime Warranty

OPTIONS:

Specify Exposed Wood Finish / Laminate (See Page 6)

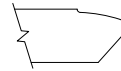

Evolve Edge Profile Standard

NOTE: All Seating Configurations Are Viewed From Left To Right Facing. Please Attach A Layout Showing Seating Configuration w/ Your Order. Assembled Units Must Be Shipped In Configurations Of 3 Or Less.

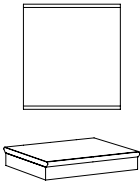
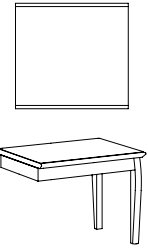
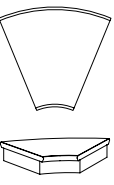
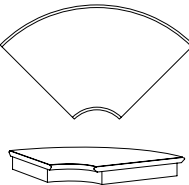
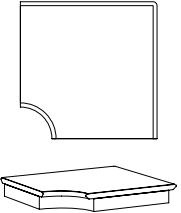
CONNECTING TABLES		ITEM #:	SPECIFICATIONS GRADES LIST PRICES:													
STRAIGHT DIVIDER TABLE			Overall: 20"w 20"d 18"h						Weight: 45 lbs.							
			COM	COL	1	2	3	4	5	6	7	8	9	10	L1	L2
	18C2020-L		732 High Pressure Laminate Face / Evolve Edge Profile Wood Band													
	18C2020-C		779 Solid Surface Top (Glacier White) / Evolve Edge Profile													
23" END TABLE			Overall: 23"w 20"d 18"h						Weight: 35 lbs.							
			COM	COL	1	2	3	4	5	6	7	8	9	10	L1	L2
	18E2320-L		875 High Pressure Laminate Face / Evolve Edge Profile Wood Band													
	18E2320-C		1363 Solid Surface Face (Glacier White) / Evolve Edge Profile													
45° CORNER TABLE			Overall: 21"w 20"d 18"h						Weight: 30 lbs.							
			COM	COL	1	2	3	4	5	6	7	8	9	10	L1	L2
	18RC45-L		689 High Pressure Laminate Face / Evolve Edge Profile Wood Band													
	18RC45-C		994 Solid Surface Face (Glacier White) / Evolve Edge Profile													
90° CORNER TABLE			Overall: 26"w 26"d 18"h						Weight: 45 lbs.							
			COM	COL	1	2	3	4	5	6	7	8	9	10	L1	L2
	18RC90-L		888 High Pressure Laminate Face / Evolve Edge Profile Wood Band													
	18RC90-C		1462 Solid Surface Face (Glacier White) / Evolve Edge Profile													
90° CORNER TABLE / METAL SUPPORT LEG			Overall: 26"w 26"d 18"h						Weight: 48 lbs.							
			COM	COL	1	2	3	4	5	6	7	8	9	10	L1	L2
	18SC2626-L		895 High Pressure Laminate Face / Evolve Edge Profile Wood Band													
	18SC2626-C		1786 Solid Surface Face (Glacier White) / Evolve Edge Profile													

DESCRIPTION:





- Edge Banding / Legs: Solid Maple
- Wilsonart Plastic Laminates Standard. Alternate Selections May Be Specified From Most Major Laminate Manufacturers. (Contact Factory For Availability)
- Lifetime Warranty

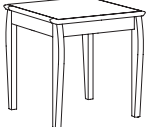
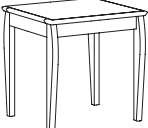

OPTIONS:

Specify Exposed Wood Finish / Laminate (See Page 6)



Evolve Edge Profile Standard

TABLES		ITEM #:	SPECIFICATIONS GRADES LIST PRICES:													
24" CORNER TABLE 			Overall: 24"w 24"d 23"h						Weight: 35 lbs.							
			COM	COL	1	2	3	4	5	6	7	8	9	10	L1	L2
	182424-L		1000	<i>High Pressure Laminate Face / Evolve Edge Profile Wood Band</i>												
	182424-C		1381	<i>Solid Surface Face (Glacier White) / Evolve Edge Profile</i>												
26" END TABLE 			Overall: 22"w 26"d 23"h						Weight: 38 lbs.							
			COM	COL	1	2	3	4	5	6	7	8	9	10	L1	L2
	182226-L		1136	<i>High Pressure Laminate Face / Evolve Edge Profile Wood Band</i>												
	182226-C		1404	<i>Solid Surface Face (Glacier White) / Evolve Edge Profile</i>												
42" RECTANGLE COFFEE TABLE 			Overall: 42"w 20"d 16"h						Weight: 40 lbs.							
			COM	COL	1	2	3	4	5	6	7	8	9	10	L1	L2
	184220-L		1253	<i>High Pressure Laminate Face / Evolve Edge Profile Wood Band</i>												
	184220-C		1786	<i>Solid Surface Face (Glacier White) / Evolve Edge Profile</i>												
26" ROUND END TABLE 			Overall: 26" Diameter 23"h						Weight: 28 lbs.							
			COM	COL	1	2	3	4	5	6	7	8	9	10	L1	L2
	1826D22-L		1355	<i>High Pressure Laminate Face / Evolve Edge Profile Wood Band</i>												
	1826D22-C		1690	<i>Solid Surface Face (Glacier White) / Evolve Edge Profile</i>												
34" ROUND COFFEE TABLE 			Overall: 34" Diameter 16"h						Weight: 50 lbs.							
			COM	COL	1	2	3	4	5	6	7	8	9	10	L1	L2
	1834D16-L		1780	<i>High Pressure Laminate Face / Evolve Edge Profile Wood Band</i>												
	1834D16-C		2714	<i>Solid Surface Face (Glacier White) / Evolve Edge Profile</i>												

ARM CAPS / COVERS	OPTION #:	SPECIFICATIONS LIST PRICES AVAILABILITY:
<p>POLYESTER ARM CAPS</p> 	<p>EPAC-1</p> <p><i>Overall: 2.75"w 22.5"d 1.125"h</i></p> <hr/> <p>\$374 (Set Of 2) POLYESTER <i>Black Polyester Arm Cap (Additional Colors Available)</i></p> <p><i>Available: Facelift Evolve Guest / Tandem Collection (1822 / 1823 / 1832 / 1833 / 1850 / /1851)</i></p>	
<p>CONTRASTING COVERS</p> 	<p>CC</p> <p><i>Overall: N/A</i></p> <hr/> <p>\$129 <i>NOTE: If Two Or More Upholsteries Or Leathers Are Used On Any Piece Of Furniture, Then A Contrast Charge Will Apply Per Order. When Using Trinity Upholstery, The Higher Priced Upholstery Grade Will Be Used In Pricing, Unless It's Trinity Leather With Fabric Contrast Welt, Or COM With Trinity Contrast Welt, Then Contact Customer Service For Pricing.</i></p> <p><i>Available: Facelift Evolve Guest / Tandem Collection</i></p>	

Facelift Evolve

HEALTHCARE MOTION

Effective: March 1, 2025

T R I N I T Y

Date:

Page:

Modification:

Description:

DESCRIPTION:

- Upholstery Frames: Steel, Plywood & Hardwood
- Seat: High Density Polyurethane Foam Over Strap Webbing
- Back: High Density Polyurethane Foam Over Sinuous Wire Springs
- Upholstered Covers: Attached w/ Velcro / Removable For Maintenance
- Exposed Wood Legs: Solid Hardwood / Removable For Maintenance
- Antimicrobial Moisture Barrier Fully Encapsulates All Foam Areas
- Leather Upholstery Not Available
- Lifetime Warranty

OPTIONS:

- Closed Arm Panels (See 1800-PL / 1800-PR Item #'s - Facelift Guest)
- Specify Exposed Wood Finish (See Page 6)

NOTE: All Seating Configurations Are Viewed From Left To Right Facing. Please Attach A Layout Showing Seating Configuration w/ Your Order. Assembled Units Must Be Shipped In Configurations Of 3 Or Less.

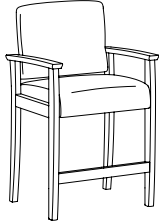
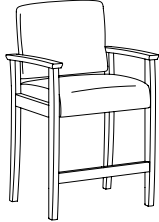
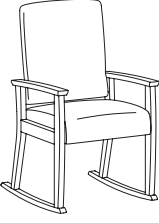
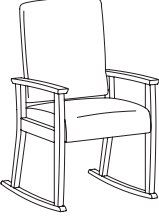
PATIENT	ITEM #:	SPECIFICATIONS GRADES LIST PRICES:													
		Overall: 23.75"w 24"d 38"h		Arm: 29.5"h					COM: 1.75 yds.						
		Seat: 20.25"w 19"d 24"h		Weight: 40 lbs.					COL: n/a						
		COM	COL	1	2	3	4	5	6	7	8	9	10	L1	L2
	1820-H	1299	N/A	1315	1358	1402	1445	1488	1532	1575	1618	1662	1705	N/A	N/A
		<i>Tight Seat & Back / Removable Upholstery / 350 lb. Weight Capacity</i>													
	1820-R	150	N/A	237	284	332	379	426	474	521	569	616	664	N/A	N/A
		<i>Replacement Upholstery Covers</i>													
		Overall: 23.75"w 24"d 38"h		Arm: 29.5"h					COM: 1.75 yds.						
		Seat: 20.25"w 19"d 24"h		Weight: 40 lbs.					COL: n/a						
		COM	COL	1	2	3	4	5	6	7	8	9	10	L1	L2
	1822-H	1336	N/A	1350	1393	1436	1480	1523	1566	1610	1653	1696	1739	N/A	N/A
		<i>Tight Seat & Back / Removable Upholstery / 350 lb. Weight Capacity</i>													
	1820-R	150	N/A	237	284	332	379	426	474	521	569	616	664	N/A	N/A
		<i>Replacement Upholstery Covers</i>													
		Overall: 23.5"w 28.75"d 45"h		Arm: 25"h					COM: 2.25 yds.						
		Seat: 20"w 19"d 18.5"h		Weight: 40 lbs.					COL: n/a						
		COM	COL	1	2	3	4	5	6	7	8	9	10	L1	L2
	1824-RK	1419	N/A	1457	1514	1572	1630	1688	1745	1803	1861	1919	1976	N/A	N/A
		<i>Tight Seat & Back / Removable Upholstery / 350 lb. Weight Capacity</i>													
	1824-R	155	N/A	273	336	400	463	526	589	652	716	779	842	N/A	N/A
		<i>Replacement Upholstery Covers</i>													
		See Available Footstools Next Page													
		Overall: 23.5"w 28.75"d 45"h		Arm: 25"h					COM: 2.25 yds.						
		Seat: 20"w 19"d 18.5"h		Weight: 40 lbs.					COL: n/a						
		COM	COL	1	2	3	4	5	6	7	8	9	10	L1	L2
	1825-RK	1437	N/A	1474	1532	1590	1647	1705	1763	1820	1878	1936	1994	N/A	N/A
		<i>Tight Seat & Back / Removable Upholstery / 350 lb. Weight Capacity</i>													
	1824-R	155	N/A	273	336	400	463	526	589	652	716	779	842	N/A	N/A
		<i>Replacement Upholstery Covers</i>													
		See Available Footstools Next Page													

DESCRIPTION:

- Upholstery Frames: Steel, Plywood & Hardwood
- Seat: High Density Polyurethane Foam Over Strap Webbing
- Back: High Density Polyurethane Foam Over Sinuous Wire Springs
- Upholstered Covers: Attached w/ Velcro / Removable For Maintenance
- Exposed Wood Legs: Solid Hardwood / Removable For Maintenance
- Antimicrobial Moisture Barrier Fully Encapsulates All Foam Areas
- Leather Upholstery Not Available
- Lifetime Warranty

OPTIONS:

- Closed Arm Panels (See 1800-PL / 1800-PR Item #'s - Facelift Guest)
- Specify Exposed Wood Finish (See Page 6)

NOTE: All Seating Configurations Are Viewed From Left To Right Facing. Please Attach A Layout Showing Seating Configuration w/ Your Order. Assembled Units Must Be Shipped In Configurations Of 3 Or Less.

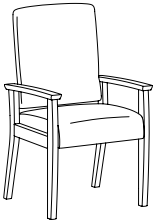
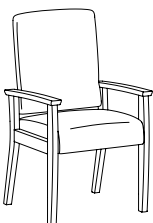
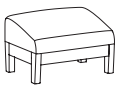
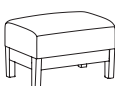
PATIENT CHAIR / FOOTSTOOL		ITEM #:	SPECIFICATIONS GRADES LIST PRICES:													
	HIGH BACK PATIENT CHAIR / WOOD ARMS		Overall: 23.5"w 26"d 45"h Seat: 20"w 19"d 18.5"h			Arm: 25"h Weight: 50 lbs.			COM: 2.25 yds. COL: n/a							
			COM	COL	1	2	3	4	5	6	7	8	9	10	L1	L2
		1824	1382	N/A	1408	1458	1509	1549	1610	1660	1711	1761	1812	1862	N/A	N/A
		1824-R	155	N/A	273	336	400	463	526	589	652	716	779	842	N/A	N/A
	Headrest/Lumbar	74	N/A	98	111	127	142	155	170	184	200	213	228	N/A	N/A	
See Available Footstools Below																
	HIGH BACK PATIENT CHAIR / URETHANE ARMS		Overall: 23.5"w 26"d 45"h Seat: 20"w 19"d 18.5"h			Arm: 25"h Weight: 50 lbs.			COM: 2.25 yds. COL: n/a							
			COM	COL	1	2	3	4	5	6	7	8	9	10	L1	L2
		1825	1388	N/A	1428	1486	1543	1601	1659	1717	1774	1832	1890	1947	N/A	N/A
		1824-R	155	N/A	273	336	400	463	526	589	652	716	779	842	N/A	N/A
	Headrest/Lumbar	74	N/A	98	111	127	142	155	170	184	200	213	228	N/A	N/A	
See Available Footstools Below																
	OTTOMAN / FOOTSTOOL / SLOPED / STOWS UNDER ALL PATIENT & GLIDER CHAIRS		Overall: 18"w 15"d 12"h Seat: n/a			Arm: n/a Weight: 27 lbs.			COM: 1.25 yds. COL: n/a							
			COM	COL	1	2	3	4	5	6	7	8	9	10	L1	L2
		1834	377	N/A	415	443	472	501	530	559	588	617	646	674	N/A	N/A
		1834-R	86	N/A	145	176	208	239	271	303	334	366	397	429	N/A	N/A
	OTTOMAN / FOOTSTOOL / FLAT / STOWS UNDER ALL PATIENT & GLIDER CHAIRS		Overall: 18"w 15"d 12"h Seat: n/a			Arm: n/a Weight: 27 lbs.			COM: 1.25 yds. COL: n/a							
			COM	COL	1	2	3	4	5	6	7	8	9	10	L1	L2
		1835	402	N/A	438	467	495	524	553	582	611	640	669	697	N/A	N/A
		1835-R	86	N/A	145	176	208	239	271	303	334	366	397	429	N/A	N/A



DESCRIPTION:



- Upholstery Frames: Steel, Plywood & Hardwood
- Seat: High Density Polyurethane Foam Over Sheet Webbing
- Back: High Density Polyurethane Foam Over Polypropylene Webbing
- Upholstered Covers: Attached w/ Velcro / Removable For Maintenance
- Removable Bolster Pillow For 1845 / 1846 (5" Diameter)
- Antimicrobial Moisture Barrier Fully Encapsulates All Foam Areas
- Double Needle Stitching Standard
- Metal To Metal Connections For All Hardware Assembly
- Leather Upholstery Not Available
- Lifetime Warranty

OPTIONS:

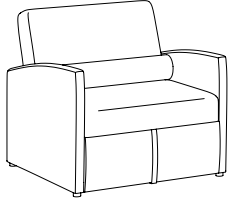
- EWAC-1 Solid Wood Arm Caps (Set Of 2)\$243
 - EUAC-1 Black Urethane Arm Caps (Set Of 2).....\$249
 - EPAC-2 Black Polyester Arm Caps (Set Of 2).....\$393
 - LC Locking Casters (Set Of 2).....\$44
 - NLC Non-Locking Casters (Set Of 2).....\$37
 - 3LC 3" Locking Casters - #1847 Model Only (Set Of 2).....\$218
 - PM1 Power/Data Module (1-Power / 1-USB 2 Port Simplex Charger)\$859
- (Additional Power/Data Modules Available - See Evolve Options)
 Feather Down & Polyester Pillows Available (See Page 5)
 Specify Exposed Wood Finish (See Page 6)
 Tablet Arm / Cup Holder Options (See Facelift Evolve Healthcare Options Pages)

SLEEPOVER UNITS

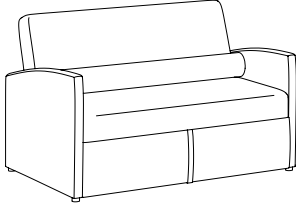
ITEM #:	SPECIFICATIONS GRADES LIST PRICES:													
LOUNGE CHAIR / FULLY UPHOLSTERED 	Overall: 33.5"w 34.5"d 33"h				Overall Length: 84"d				Arm: 24"h		COM: 6.5 yds.			
	Sleep Area: 28"w 80"d				Seat: 28"w 23"d 17.5"h				Weight: 175 lbs.		COL: n/a			
	COM	COL	1	2	3	4	5	6	7	8	9	10	L1	L2
1845	4148	N/A	4808	4989	5169	5349	5530	5710	5891	6071	6251	6432	N/A	N/A
	<i>Tight Seat & Back / Removable Upholstery / 500 lbs. Weight Capacity</i>													
1845-R	325	N/A	702	900	1097	1295	1493	1690	1888	2085	2283	2480	N/A	N/A
	<i>Replacement Upholstery Covers</i>													
														

TWO PLACE SOFA / FULLY UPHOLSTERED 	Overall: 53"w 34.5"d 33"h				Overall Length: 84"d				Arm: 24"h		COM: 9 yds.			
	Sleep Area: 48"w 80"d				Seat: 48"w 23"d 17.5"h				Weight: 220 lbs.		COL: n/a			
	COM	COL	1	2	3	4	5	6	7	8	9	10	L1	L2
1846	5292	N/A	6179	6431	6684	6937	7189	7442	7694	7947	8199	8452	N/A	N/A
	<i>Tight Seat & Back / Removable Upholstery / 750 lbs. Weight Capacity</i>													
1846-R	387	N/A	919	1195	1472	1749	2025	2302	2579	2855	3132	3408	N/A	N/A
	<i>Replacement Upholstery Covers</i>													
														

FOUR POSITION ADJUSTMENT FOR 1845 / 1846

 See **Replay Healthcare Motion And Revival Healthcare Motion (Page 242)** For Additional Sleepover Units.

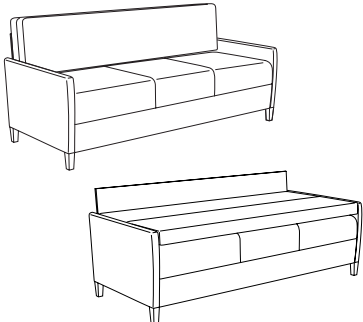

BACK-FLIP SLEEPER SOFA 	Overall: 76"w 36"d 36"h				Arm: 24.5"h				COM: 12.25 yds.					
	Sleep Area: 70"w 31"d 20"h				Weight: 235 lbs.				COL: n/a					
	COM	COL	1	2	3	4	5	6	7	8	9	10	L1	L2
1847	4308	N/A	4766	5113	5459	5805	6152	6498	6844	7191	7537	7883	N/A	N/A
	<i>Tight Seat & Back / Removable Upholstery / 1000 lbs. Weight Capacity</i>													
1847-R	1254	N/A	1945	2324	2703	3083	3462	3841	4221	4600	4979	5359	N/A	N/A
	<i>Replacement Upholstery Covers</i>													

DESCRIPTION:

- Upholstery Frames: Steel, Plywood & Hardwood
- Seat: High Density Polyurethane Foam Over Sheet Webbing
- Back: High Density Polyurethane Foam Over Polypropylene Webbing
- Upholstered Covers: Attached w/ Velcro / Removable For Maintenance
- Antimicrobial Moisture Barrier Fully Encapsulates All Foam Areas
- Double Needle Stitching Standard
- Exposed Wood Legs: Solid Hardwood / Removable For Maintenance
- Leather Upholstery Not Available
- Lifetime Warranty

OPTIONS:

- EWAC-1 Solid Wood Arm Caps (Set Of 2)\$243
 - EUAC-1 Black Urethane Arm Caps (Set Of 2).....\$249
 - EPAC-2 Black Polyester Arm Caps (Set Of 2).....\$393
 - ARL Brushed Aluminum Round Legs (Set Of 4).....\$353
 - WR Wood Ring Base - Replaces Metal Base On 1854-G/1854-SG\$224
 - PM1 Power/Data Module (1-Power / 1-USB 2 Port Simplex Charger)\$859
- (Additional Power/Data Modules Available - See Evolve Options)
- Feather Down & Polyester Pillows Available (See Page 5)
- Specify Exposed Wood Finish (See Page 6)
- Tablet Arm / Cup Holder Options (See Facelift Evolve Healthcare Options Pages)

PATIENT CHAIR / GLIDER

ITEM #:

SPECIFICATIONS | GRADES | LIST PRICES:

ASYNCHRONOUS PATIENT CHAIR / FULLY UPHOLSTERED

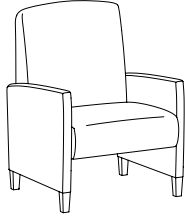

Healthcare Motion

Overall: 25"w 33.5"d 39.25"h **Arm:** 24.25"h **COM:** 4.25 yds.
Seat: 21"w 20"d 18.75"h **Weight:** 63 lbs. **COL:** n/a

COM	COL	1	2	3	4	5	6	7	8	9	10	L1	L2
1852	N/A	1800	1934	2068	2201	2335	2469	2602	2736	2870	3003	N/A	N/A
<i>Tight Seat & Back / Removable Upholstery / 500 lb. Weight Capacity</i>													
1852-R	N/A	482	609	735	862	988	1115	1241	1368	1494	1621	N/A	N/A
<i>Replacement Upholstery Covers</i>													

OTTOMAN ON CASTERS / STOWS UNDER ALL PATIENT CHAIRS

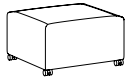

Healthcare Motion

Overall: 18"w 18"d 11"h **Arm:** n/a **COM:** 1 yd.
Seat: n/a **Weight:** 25 lbs. **COL:** n/a

COM	COL	1	2	3	4	5	6	7	8	9	10	L1	L2
1809	N/A	409	430	452	474	495	517	539	560	582	603	N/A	N/A
<i>Removable Upholstery / 350 lb. Weight Capacity</i>													
1809-R	N/A	136	160	183	207	231	254	278	302	326	349	N/A	N/A
<i>Replacement Upholstery Covers</i>													

LOUNGE GLIDER / FULLY UPHOLSTERED

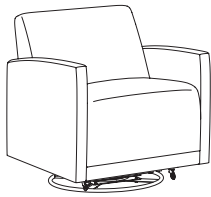

Healthcare Motion

Overall: 27"w 32"d 35"h **Arm:** 24"h **COM:** 4.5 yds.
Seat: 21"w 20"d 18"h **Weight:** 115 lbs. **COL:** n/a

COM	COL	1	2	3	4	5	6	7	8	9	10	L1	L2
1854-G	N/A	2053	2175	2298	2421	2543	2666	2789	2911	3034	3157	N/A	N/A
<i>Circular Metal Base / Tight Seat & Back / Removable Upholstery / 500 lb. Weight Capacity</i>													
1854-SG	N/A	2174	2297	2419	2542	2665	2787	2910	3033	3155	3278	N/A	N/A
<i>Swivel Glider w/ Circular Metal Base / Tight Seat & Back / Removable Upholstery / 500 lb. Weight Capacity</i>													
1854-R	N/A	506	641	775	909	1044	1178	1313	1447	1581	1716	N/A	N/A
<i>Replacement Upholstery Covers</i>													

See Replay Healthcare Motion And Revival Healthcare Motion For Additional Patient Chairs & Gliders.











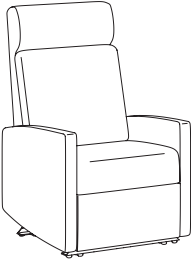

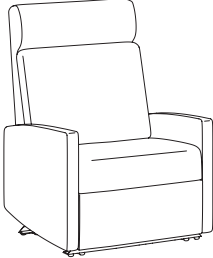
DESCRIPTION:

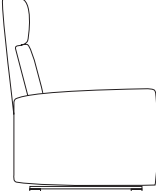
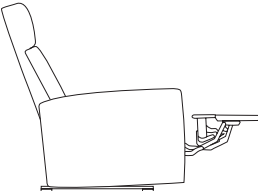
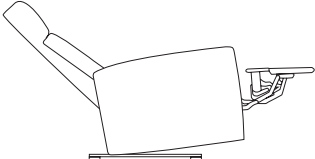
- Upholstery Frames: Steel, Plywood & Hardwood
- Seat: High Density Polyurethane Foam Over Sheet Webbing
- Back: High Density Polyurethane Foam Over Sinuous Wire Springs
- Upholstered Covers: Attached w/ Velcro / Removable For Maintenance
- Antimicrobial Moisture Barrier Fully Encapsulates All Foam Areas
- Double Needle Stitching Standard (Welting Optional - No Charge)
- Dual-Wheel Casters: (2) Front Locking/Swivel & (2) Rear Non-Locking/Non-Swivel (1865)
- (2) Drop Down Side Trays Mounted To Black Metal Tubing (1865)
- Leather Upholstery Not Available
- Lifetime Warranty

OPTIONS:

(See Facelift Evolve Healthcare Options Pages)

Feather Down & Polyester Pillows Available (See Page 5)

WALLSAVER / INFUSION RECLINER		ITEM #:	SPECIFICATIONS GRADES LIST PRICES:														
			Overall: 27"w 34"d 41.5"h			Arm: 23"h			COM: 4.75 yds.								
			Seat: 21"w 21.5"d 18"h			Weight: 110 lbs.			COL: n/a								
			COM	COL	1	2	3	4	5	6	7	8	9	10	L1	L2	
	1855		2069	N/A	2257	2407	2558	2708	2858	3009	3159	3309	3460	3610	N/A	N/A	
			<i>Tight Seat & Back / Removable Upholstery / 6" Wall Proximity / 350 lb. Weight Capacity</i>														
	1855-R		291	N/A	559	702	844	986	1129	1271	1413	1555	1698	1840	N/A	N/A	
			<i>Replacement Upholstery Covers</i>														
			 Healthcare Motion														
			Overall: 32"w 34"d 41.5"h			Arm: 23"h			COM: 5.25 yds.								
			Seat: 26"w 21.5"d 18"h			Weight: 120 lbs.			COL: n/a								
			COM	COL	1	2	3	4	5	6	7	8	9	10	L1	L2	
	1855-X		2133	N/A	2351	2518	2685	2852	3019	3186	3353	3520	3687	3854	N/A	N/A	
			<i>Tight Seat & Back / Removable Upholstery / 6" Wall Proximity / 500 lb. Weight Capacity</i>														
	1855-XR		298	N/A	597	755	914	1072	1230	1388	1546	1704	1862	2020	N/A	N/A	
			<i>Replacement Upholstery Covers</i>														
			 Healthcare Motion														
			 See <i>Replay Healthcare Motion And Revival Healthcare Motion For Additional Wallsaver Recliners.</i>														
						 Upright Position 34"D			 Extended Footrest Position 54.5"D			 Full Recline Position 65.5"D					
			Overall: 26.25"w 34"d 46"h			Arm: 27"h			COM: 5 yds.								
			Seat: 21"w 20.5"d 19"h			Weight: 130 lbs.			COL: n/a								
			COM	COL	1	2	3	4	5	6	7	8	9	10	L1	L2	
	1865		2999	N/A	3141	3293	3446	3599	3751	3904	4057	4210	4362	4515	N/A	N/A	
			<i>Tight Seat & Back / Removable Upholstery / 350 lb. Weight Capacity</i>														
	1865-R		323	N/A	653	827	1001	1175	1349	1523	1697	1870	2044	2218	N/A	N/A	
			<i>Replacement Upholstery Covers</i>														
			 Healthcare Motion														
			 See <i>Replay & Revival Healthcare Motion For Additional Infusion Wallsaver Recliners.</i>														
						 Upright Position 32"D			 Extended Footrest Position 52"D			 Full Recline Position 64.5"D					
			 Optional Central Braking Available														

DESCRIPTION:

- Upholstery Frames: Steel, Plywood & Hardwood
- Seat: High Density Polyurethane Foam Over Sheet Webbing
- Back: High Density Polyurethane Foam Over Sinuous Wire Springs
- Upholstered Covers: Attached w/ Velcro / Removable For Maintenance
- Antimicrobial Moisture Barrier Fully Encapsulates All Foam Areas
- Double Needle Stitching Standard (Welting Optional - No Charge)
- Rotational & Directional Locking Casters (Rear)
- Leather Upholstery Not Available
- Lifetime Warranty

OPTIONS:

Layflat Medical Recliner Options (See Facelift Evolve Healthcare Options Pages)
 Feather Down & Polyester Pillows Available (See Page 5)

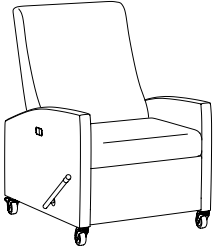
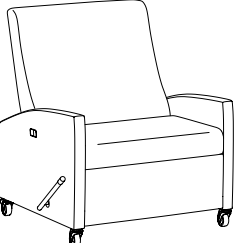
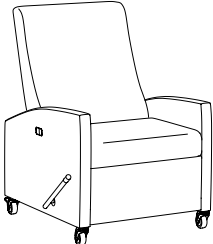
LAYFLAT MEDICAL RECLINER		ITEM #:	SPECIFICATIONS GRADES LIST PRICES:													
		LAYFLAT / TRENDELENBURG RECLINER 1857-L 1857-T 1857-R	Overall: 30"w 38.5"d 45"h Seat: 24"w 20"d 20"h			Arm: 28"h Weight: 175 lbs.			COM: 5.5 yds. COL: n/a							
			COM	COL	1	2	3	4	5	6	7	8	9	10	L1	L2
			3656	N/A	3808	3983	4159	4334	4509	4685	4860	5036	5211	5386	N/A	N/A
			<i>Layflat / Tight Seat & Back / Removable Upholstery / 500 lb. Weight Capacity</i>													
<i>Trendelenburg / Tight Seat & Back / Removable Upholstery / 500 lb. Weight Capacity</i>																
<i>Replacement Upholstery Covers</i>																
		BARIATRIC LAYFLAT / TRENDELENBURG RECLINER 1857-XL 1857-XT 1857-XR	Overall: 35"w 38.5"d 45"h Seat: 29"w 20"d 20"h			Arm: 28"h Weight: 200 lbs.			COM: 6 yds. COL: n/a							
			COM	COL	1	2	3	4	5	6	7	8	9	10	L1	L2
			3784	N/A	3961	4154	4346	4538	4730	4922	5114	5306	5498	5690	N/A	N/A
			<i>Bariatric Layflat / Tight Seat & Back / Removable Upholstery / 600 lb. Weight Capacity</i>													
<i>Bariatric Trendelenburg / Tight Seat & Back / Removable Upholstery / 600 lb. Weight Capacity</i>																
<i>Replacement Upholstery Covers</i>																
		LAYFLAT GLIDER / RECLINER 1857-LG 1857-LGR	Overall: 28"w 38.5"d 45"h Seat: 23"w 20"d 19"h			Arm: 27"h Weight: 175 lbs.			COM: 5.5 yds. COL: n/a							
			COM	COL	1	2	3	4	5	6	7	8	9	10	L1	L2
			4208	N/A	4362	4554	4747	4939	5131	5323	5515	5707	5899	6091	N/A	N/A
			<i>Layflat Glider / Tight Seat & Back / Removable Upholstery / 500 lb. Weight Capacity</i>													
<i>Replacement Upholstery Covers</i>																



 See **Replay Healthcare Motion And Revival Healthcare Motion For Additional Layflat Medical Recliners.**

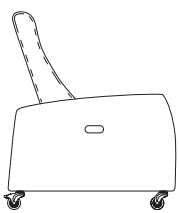

Upright Position
38.5"D

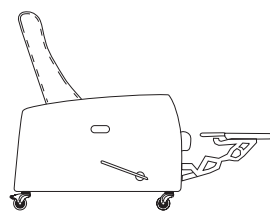

Extended Footrest Position
57.5"D

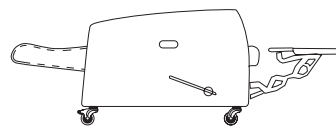



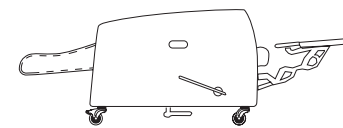





Layflat Position
73.75"D



Trendelenburg Position
74.75"D

ARM CAPS / TABLET ARMS	OPTION #:	SPECIFICATIONS LIST PRICES AVAILABILITY:
<p>SOLID WOOD / URETHANE / POLYESTER ARM CAPS (Upholstered Arm Chairs)</p>   	<p>Overall: 2.75"w 29"d 1.125"h</p> <p>EWAC-1 \$243 (Set Of 2) WOOD (1845 / 1846 Sleepover Lounge) - Specify Finish (1852 Asynchronous Patient Chair) - Specify Finish (1854-G Lounge Glider / 1854-SG Lounge Swivel Glider) - Specify Finish (1855 Wallsaver Recliner / 1855-X Bariatric Wallsaver Recliner) - Specify Finish (1857-L & 1857-T Medical Recliners / 1857-XL & 1857-XT Bariatric Medical Recliners) - Specify Finish</p> <p>EUAC-1 \$249 (Set Of 2) URETHANE (1845 / 1846 Sleepover Lounge) (1852 Asynchronous Patient Chair) (1854-G Lounge Glider / 1854-SG Lounge Swivel Glider) (1855 Wallsaver Recliner / 1855-X Bariatric Wallsaver Recliner) (1857-L & 1857-T Medical Recliners / 1857-XL & 1857-XT Bariatric Medical Recliners)</p> <p>EPAC-2 \$393 (Set Of 2) POLYESTER (1845 / 1846 Sleepover Lounge) (1852 Asynchronous Patient Chair) (1854-G Lounge Glider / 1854-SG Lounge Swivel Glider) (1855 Wallsaver Recliner / 1855-X Bariatric Wallsaver Recliner) (1857-L & 1857-T Medical Recliners / 1857-XL & 1857-XT Bariatric Medical Recliners)</p> <p><i>Black Polyester Arm Cap (Additional Colors Available)</i></p>	
<p>TABLET ARMS / CUP HOLDER</p>  <p>Laminate Tablet Arm Shown w/ Cup Holder</p>  <p>Veneer Tablet Arm Shown w/ Cup Holder</p>  <p>Solid Surface Tablet Arm Shown w/ Cup Holder</p>	<p>Overall: 14" Diameter .75"h</p> <p>TA-L \$509 <i>Tablet Arm With 360° Rotation - High Pressure Laminate. (Specify Laminate / Specify Left Or Right Facing Arm Location)</i></p> <p>TA-V \$580 <i>Tablet Arm With 360° Rotation - Sunburst Cherry Veneer. (Specify Finish / Specify Left Or Right Facing Arm Location)</i></p> <p>TA-C \$698 <i>Tablet Arm With 360° Rotation - White Solid Surface. (Available In White Only / Specify Left Or Right Facing Arm Location)</i></p> <p>CH-1 \$129 <i>Black Plastic Cup Holder (Only Available If Used With Tablet Arm)</i></p> <p>CH-2 \$186 <i>Spun Aluminum Cup Holder (Only Available If Used With Tablet Arm)</i></p> <p>Available: <i>Facelift Evolve Healthcare Collection</i></p>	
<p>FOLD DOWN TABLET ARM</p>  	<p>Overall: 14" Diameter .75"h</p> <p>FDTA-L \$1065 <i>Tablet Arm With 360° Rotation - High Pressure Laminate. (Specify Laminate / Specify Left Or Right Facing Arm Location)</i></p> <p>FDTA-V \$1136 <i>Tablet Arm With 360° Rotation - Sunburst Cherry Veneer. (Specify Finish / Specify Left Or Right Facing Arm Location)</i></p> <p>FDTA-C \$1278 <i>Tablet Arm With 360° Rotation - White Solid Surface. (Available In White Only / Specify Left Or Right Facing Arm Location)</i></p> <p>Available: <i>Facelift Evolve Healthcare Collection</i></p>	

TABLET ARMS / POWER / CASTERS	OPTION #:	SPECIFICATIONS LIST PRICES AVAILABILITY:
<p>DOUBLE ARTICULATING / SWIVEL TABLET ARM</p>  <p>ATA-L Double Articulating / Swivel Tablet Arm</p>  <p>ATA-L w/ CH-1 Black Plastic Cup Holder</p>	<p>Overall: 14" Diameter .75"h</p> <hr/> <p>ATA-L \$983 <i>Tablet Arm With 360° Rotation - High Pressure Laminate. (Specify Laminate / Specify Left Or Right Facing Arm Location)</i></p> <p>ATA-V \$1055 <i>Tablet Arm With 360° Rotation - Sunburst Cherry Veneer. (Specify Finish / Specify Left Or Right Facing Arm Location)</i></p> <p>ATA-C \$1173 <i>Tablet Arm With 360° Rotation - White Solid Surface. (Available In White Only / Specify Left Or Right Facing Arm Location)</i></p> <p>CH-1 \$129 <i>Black Plastic Cup Holder (Only Available If Used With Tablet Arm)</i></p> <p>CH-2 \$186 <i>Spun Aluminum Cup Holder (Only Available If Used With Tablet Arm)</i></p> <p>Available: <i>Facelift Evolve Healthcare Collection</i></p> <hr/> <p>SIDE MOUNT / FOLD DOWN TABLET W/ LOCK & SWIVEL</p> <p>Overall: 14" Diameter .75"h</p>	
	<p>SMFDT-L \$722 <i>Up & Away w/ Lock & High Pressure Laminate Top. (Specify Laminate / Specify Left Or Right Facing Arm Location)</i></p> <p>SMFDT-V \$1007 <i>Up & Away w/ Lock & Veneer Top. (Specify Finish / Specify Left Or Right Facing Arm Location)</i></p> <p>SMFDT-C \$1126 <i>Up & Away w/ Lock & White Solid Surface Top. (Available In White Only / Specify Left Or Right Facing Arm Location)</i></p> <p>Available: <i>Facelift Evolve 1857</i></p>	
<p>POWER / DATA MODULE</p>  <p>PM1 Power / Data Module</p>  <p>PM2 Power Module</p>  <p>USB-1 Dual Charging USB</p>	<p>PM1 Overall: 5.25"w 1.25"d 4.25"h PM2 Overall: 2"w 2"d .125"h USB-1 Overall: 2"w 2"d .125"h</p> <hr/> <p>PM1 \$859 Power/Data Module (1-Power / 1-USB 2 Port Simplex Charger Standard) <i>Vertical / Horizontal Mount Power Module. Price Varies By Socket. Contact Customer Service For Quote. (Additional Colors Available)</i></p> <p>PM2 \$238 Power Module (1-Power) <i>Spill-Proof Technology / Multiple Finish Options / Storm Color Standard (Specify Left or Right Facing)</i></p> <p>USB-1 \$238 Dual Charging USB (2 Port Simplex Charger Standard) <i>Spill-Proof Technology / 2 Amps Per Port / Multiple Finish Options / Storm Color Standard (Specify Left or Right Facing)</i></p> <p>Available: <i>Facelift Evolve Sleepover Lounge (1845, 1846, 1847 Models)</i></p>	
<p>LOCKING / NON-LOCKING CASTERS</p>  <p>Locking Casters</p>  <p>Non-Locking Casters</p>	<p>Overall: 1.875"w 2.25"d 1.5"h (Locking) / 1.875"w 1.625"d 1.5"h (Non-Locking)</p> <hr/> <p>LC \$44 (Set Of Two) <i>Locking Casters (Black Finish / Specify Location)</i></p> <p>NLC \$37 (Set Of Two) <i>Non-Locking Casters (Black Finish / Specify Location)</i></p> <p>Available: <i>Facelift Evolve Sleepover Lounge (1844-1845 Models)</i></p>	
<p>WALLSAVER - LOCKING / NON-LOCKING CASTERS</p>  <p>Locking Casters</p>  <p>Non-Locking Casters</p>	<p>Overall: 2.5"w 4"d 3.5"h (Locking) / 2.5"w 3.25"d 3.5"h (Non-Locking)</p> <hr/> <p>WLC \$199 List (Set Of Two) <i>Locking Swivel Casters (Gray Finish / Back Location)</i></p> <p>WNLC \$185 List (Set Of Two) <i>Non-Locking / Non-Swivel Casters (Gray Finish / Front Location)</i></p> <p>Note: <i>Wallsaver Locking / Non-Locking Casters Cannot Be Used In Combination With Electric Recline.</i></p> <p>Available: <i>Facelift Wallsaver Recliners (1511 / 1811 / 1855 & Bariatric Versions)</i></p>	

CASTERS / BRAKE / LEGS / ELECTRIC / FOLD DOWN ARM	OPTION #:	SPECIFICATIONS LIST PRICES AVAILABILITY:
<p>MEDICAL LOCKING / NON-LOCKING CASTERS</p>  <p>Locking Casters</p>  <p>Non-Locking Casters</p>	<p>MLC</p> <p>MNLC</p>	<p>Overall: 2.25"w 5"d 5.25"h (Locking) / 2"w 3.75"d 5.25"h (Non-Locking)</p> <hr/> <p>\$194 (Set Of Two) <i>Locking Casters - Motion & Direction (Gray Finish / Specify Location)</i></p> <p>\$224 (Set Of Two) <i>Non-Locking Casters - Single Direction (Gray Finish / Specify Location)</i></p> <p>Available: <i>Facelift Evolve Medical Recliners</i></p>
<p>CENTRAL BRAKING</p> 	<p>CB-1</p> <p>CB-2</p>	<p>Overall: 7.5"w 2"d .5"h</p> <hr/> <p>\$508 (Set Of 1) <i>(Gray Plastic Brake w/ Lock & Unlock Pedals)</i></p> <p>Available: <i>Wallsavers / Infusion 1855 1865</i></p> <p>\$510 (Set Of 1) <i>(Gray Plastic Brake w/ Lock & Unlock Pedals)</i></p> <p>Available: <i>Layflat 1857 L/T 1867 L/T</i></p>
<p>BRUSHED ALUMINUM ROUND LEGS</p> 	<p>ARL</p>	<p>Overall: 2" Diameter 5"h</p> <hr/> <p>\$353 (Set Of 4) <i>(Brushed Aluminum Finish)</i></p> <p>Available: <i>Facelift Evolve Asynchronous Patient Chair (1852 Model)</i></p>
<p>ELECTRIC RECLINE / BATTERY BACKUP / HEAT / MASSAGE</p>  <p>ER-1 Electric Recline <i>(Wallsaver Model)</i></p>  <p>ER-2/ER-3 Electric Recline <i>(Layflat Model)</i></p>  <p>HM Heat & Massage <i>(All Recliner Models)</i></p>  <p>H Heat <i>(All Recliner Models)</i></p>	<p>ER-1</p> <p>ER-2</p> <p>ER-3</p> <p>BB</p> <p>HM</p> <p>H</p>	<p>Overall: N/A</p> <hr/> <p>\$1054 Electric Recline <i>Replaces Manual Mechanism On Any Wallsaver Model - Surface Mounts On Inside Arm (Specify Left Or Right Facing)</i> *NOTE: ELECTRIC OPTION NOT AVAILABLE ON INFUSION RECLINERS IN COMBINATION WITH CASTERS.</p> <p>\$1087 Electric Recline <i>Replaces Manual Mechanism On Any Layflat Model - Surface Mounts On Inside Arm (Specify Left Or Right Facing)</i></p> <p>\$1149 Electric Recline <i>Replaces Manual Mechanism On Any Trendelenburg Layflat Model - Surface Mounts On Inside Arm (Specify Left Or Right Facing)</i></p> <p>\$548 Battery Backup <i>Allows Any Wallsaver, Layflat, Or Standup Electric Recliner To Be Cordless - Surface Mounts On Inside Arm (Specify Left Or Right Facing)</i></p> <p>\$1498 Heat & Massage <i>Add Heat & Massage To Any Wallsaver, Layflat, Or Standup Electric Recliner - Surface Mounts On Inside Arm (Specify Left Or Right Facing)</i></p> <p>\$1142 Heat <i>Add Heat Only To Any Wallsaver, Layflat, Or Standup Electric Recliner - Surface Mounts On Inside Arm (Specify Left Or Right Facing)</i></p> <p>Available: <i>Facelift Evolve Recliners</i></p>

FOLD DOWN ARM / PUSH BAR / I.V. POLE / SIDE TRAY	OPTION #:	SPECIFICATIONS LIST PRICES AVAILABILITY:
<p>FOLD DOWN ARM</p> 	<p>FDA-1</p>	<p>Overall: 24"w 2.5"d 10"h</p> <hr/> <p>\$655 Per Arm Piano Hinged Fold Down Arm.</p> <p>Available: Facelift 3 Evolve Wallsaver Recliner (1855 - Right Facing Only), Layflat Medical Recliner (1857 - Right Facing Only) Four Position Recliner(1858 - Left and/or Right Facing) Note: If Two Fold Down Arms (Left & Right) Are Requested On A Recliner, The Electric Wand Must Be Specified.</p>
<p>PUSH BAR</p> 	<p>PB</p>	<p>Overall: 18.5"w 3.5"d 1"h</p> <hr/> <p>\$267 (Black Finish)</p> <p>Available: Facelift Evolve Medical Recliners</p>
<p>I.V. POLE</p> 	<p>IV</p>	<p>Overall: 10"w 2.5"d 39.5" / 69.75"h</p> <hr/> <p>\$489 Height Adjustable I.V. Pole (Chrome & Black Finish / Specify Left Or Right Facing Location)</p> <p>Available: Facelift Evolve Medical Recliners</p>
<p>SIDE TRAY</p> 	<p>ST-1 ST-2 WST</p>	<p>Overall: 12.75"w 10"d 4"h (Small Side Tray) / 17"w 10"d 4"h (Large Side Tray)</p> <hr/> <p>\$368 Drop-Down Side Tray (Small Side Tray) NOTE: Attaches Directly To Outside Of Arm</p> <p>\$415 Drop-Down Side Tray (Large Side Tray) NOTE: Attaches Directly To Outside Of Arm</p> <p>Available: Facelift Replay Medical Recliners Note: If A Medical Recliner With A Manual Mechanism Is Selected, The Standard Side Tray Location Will Be Front Right Facing</p> <p>\$598 Drop-Down Side Tray (Large Side Tray) NOTE: Attaches To Metal Tubing</p> <p>Available: Facelift Wallsaver Recliners With Casters Option (1855)</p>

BAG HOLDER / BUCKLE FOOTREST / OXYGEN TANK HOLDER / RING BASE	OPTION #:	SPECIFICATIONS LIST PRICES AVAILABILITY:
<p>BAG HOLDER / PERSONAL RESTRAINT BUCKLE</p> 	<p>Overall: 2.19"w .38"d 2.56"h</p> <hr/> <p>BH \$86 <i>Bag Holder (Brushed Finish / Specify Left Or Right Facing Location)</i></p> <p>RB \$133 (Set Of 2) <i>Personal Restraint Buckle (Brushed Finish)</i></p> <p>Available: <i>Facelift Evolve Medical Recliners</i> <i>Note: If A Medical Recliner With A Manual Mechanism Is Selected, The Standard Side Tray Location Will Be Front Right Facing</i></p>	
<p>FOOTREST</p> 	<p>Overall: 16"w 8"d .1875"h</p> <hr/> <p>FR \$408 <i>(Black Finish)</i></p> <p>Available: <i>Facelift Evolve Medical Recliners</i></p>	
<p>OXYGEN TANK HOLDER</p> 	<p>Overall: 4.75" Diameter 9.75"h</p> <hr/> <p>OH \$247 <i>Black Metal Oxygen Tank Holder Holds a 4.375" Diameter Oxygen Tank (Not Included) (Specify Left Or Right Facing Location)</i></p> <p>Available: <i>Facelift Evolve Medical Recliners</i></p>	
<p>LOUNGE GLIDER WOOD RING BASE</p> 	<p>Overall: 22"dia. 3"h</p> <hr/> <p>WR \$224 <i>Wood Ring Base replaces circular metal base (1854-G) or swivel glider w/ circular metal base (1854-SG).</i></p> <p><i>Specify Exposed Wood Finish. (See Page 6)</i></p> <p>Available: <i>Facelift Evolve Lounge Glider</i></p>	

COVERS / SPRINGS	OPTION #:	SPECIFICATIONS LIST PRICES AVAILABILITY:
<p>CONTRASTING COVERS</p> 	<p>Overall: N/A</p> <hr/> <p>CC \$129 <i>NOTE: If Two Or More Upholsteries Or Leathers Are Used On Any Piece Of Furniture, Then A Contrast Charge Will Apply Per Order. When Using Trinity Upholstery, The Higher Priced Upholstery Grade Will Be Used In Pricing, Unless It's Trinity Leather With Fabric Contrast Welt, Or COM With Trinity Contrast Welt, Then Contact Customer Service For Pricing.</i></p> <p>Available: <i>Facelift Evolve Healthcare Motion</i></p>	

Facelift Evolve

HEALTHCARE MOTION
Weight-Activated Medical Recliners

Effective: March 1, 2025

T R I N I T Y

Date:

Page:

Modification:

Description:

DESCRIPTION:

- Upholstery Frames: Plywood, Hardwood & Steel
- Seat: High Density Polyurethane Foam Over Sheet Webbing
- Back: High Density Polyurethane Foam Over Sinuous Wire Springs
- Upholstered Covers: Attached w/ Velcro / Removable For Maintenance
- Antimicrobial Moisture Barrier Fully Encapsulates All Foam Areas
- Double Needle Stitching Standard (Wetling Optional - No Charge)
- Rotational & Directional Locking Casters (Rear)
- Leather Upholstery Not Available
- Lifetime Warranty

OPTIONS:

(See Weight Activated Medical Recliner Options Pages)

Feather Down & Polyester Pillows Available (See Page 5)

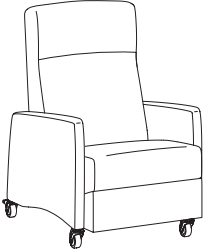
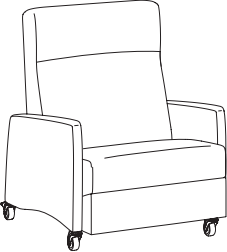
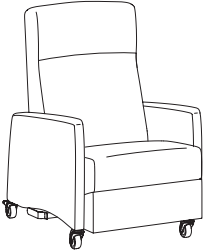
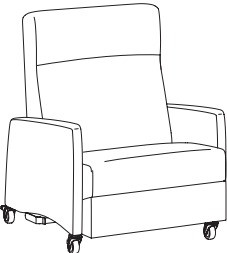
FULLY UPHOLSTERED ARM		ITEM #:	SPECIFICATIONS GRADES LIST PRICES:													
	THREE POSITION RECLINER / UPHOLSTERED ARM		Overall: 28.5"w 37"d 47"h Seat: 23.5"w 20"d 20"h		Arm: 26"h Weight: 140 lbs.				COM: 5.75 yds. COL: n/a							
			COM	COL	1	2	3	4	5	6	7	8	9	10	L1	L2
	1858		2826	N/A	3039	3223	3407	3590	3774	3958	4142	4325	4509	4693	N/A	N/A
		<i>Tight Seat & Back / Removable Upholstery / 350 lb. Weight Capacity</i>														
	1858-R	360	N/A	688	862	1035	1209	1383	1557	1731	1905	2079	2253	N/A	N/A	
		<i>Replacement Upholstery Covers</i>														
	BARIATRIC THREE POSITION RECLINER / UPHOLSTERED ARM		Overall: 33.5"w 37"d 47"h Seat: 28.5"w 20"d 20"h		Arm: 26"h Weight: 155 lbs.				COM: 5.75 yds. COL: n/a							
			COM	COL	1	2	3	4	5	6	7	8	9	10	L1	L2
	1858-X		2939	N/A	3146	3330	3513	3697	3881	4065	4248	4432	4616	4800	N/A	N/A
		<i>Tight Seat & Back / Removable Upholstery / 500 lb. Weight Capacity</i>														
	1858-XR	366	N/A	694	868	1042	1216	1389	1563	1737	1911	2085	2259	N/A	N/A	
		<i>Replacement Upholstery Covers</i>														
	TRENDELENBURG FOUR POSITION RECLINER / UPHOLSTERED ARM		Overall: 28.5"w 37"d 47"h Seat: 23.5"w 20"d 20"h		Arm: 26"h Weight: 140 lbs.				COM: 5.75 yds. COL: n/a							
			COM	COL	1	2	3	4	5	6	7	8	9	10	L1	L2
	1858-T		3066	N/A	3266	3450	3634	3817	4001	4185	4369	4552	4736	4920	N/A	N/A
		<i>Tight Seat & Back / Removable Upholstery / 350 lb. Weight Capacity</i>														
	1858-TR	360	N/A	688	862	1035	1209	1383	1557	1731	1905	2079	2253	N/A	N/A	
		<i>Replacement Upholstery Covers</i>														
	BARIATRIC TRENDELENBURG FOUR POSITION RECLINER / UPHOLSTERED ARM		Overall: 33.5"w 37"d 47"h Seat: 28.5"w 20"d 20"h		Arm: 26"h Weight: 155 lbs.				COM: 5.75 yds. COL: n/a							
			COM	COL	1	2	3	4	5	6	7	8	9	10	L1	L2
	1858-XT		3179	N/A	3373	3557	3741	3924	4108	4292	4476	4659	4843	5027	N/A	N/A
		<i>Tight Seat & Back / Removable Upholstery / 500 lb. Weight Capacity</i>														
	1858-XTR	366	N/A	694	868	1042	1216	1389	1563	1737	1911	2085	2259	N/A	N/A	
		<i>Replacement Upholstery Covers</i>														



DESCRIPTION:

- Upholstery Frames: Plywood, Hardwood & Steel
- Seat: High Density Polyurethane Foam Over Sheet Webbing
- Back: High Density Polyurethane Foam Over Sinuous Wire Springs
- Upholstered Covers: Attached w/ Velcro / Removable For Maintenance
- Antimicrobial Moisture Barrier Fully Encapsulates All Foam Areas
- Double Needle Stitching Standard (Wetling Optional - No Charge)
- Rotational & Directional Locking Casters (Rear)
- Leather Upholstery Not Available
- Lifetime Warranty

OPTIONS:

(See Weight Activated Medical Recliner Options Pages)

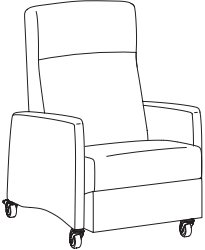
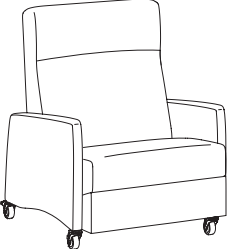
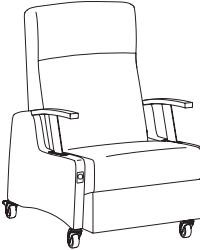
Feather Down & Polyester Pillows Available (See Page 5)

DROP-DOWN ARM		ITEM #:	SPECIFICATIONS GRADES LIST PRICES:												
	ELECTRIC MULTI-POSITION RECLINER / UPHOLSTERED ARM		<i>Overall: 28.5"w 37"d 47"h</i>				<i>Arm: 26"h</i>				<i>COM: 5.75 yds.</i>				
			<i>Seat: 23.5"w 20"d 20"h</i>				<i>Weight: 140 lbs.</i>				<i>COL: n/a</i>				
			COM	COL	1	2	3	4	5	6	7	8	9	10	L1
	1868-E	3826	N/A	4039	4223	4407	4590	4774	4958	5142	5325	5509	5693	N/A	N/A
		<i>Tight Seat & Back / Removable Upholstery / 350 lb. Weight Capacity</i>													
	1868-ER	360	N/A	688	862	1035	1209	1383	1557	1731	1905	2079	2253	N/A	N/A
		<i>Replacement Upholstery Covers</i>													
	BARIATRIC ELECTRIC MULTI-POSITION RECLINER / UPHOLSTERED ARM		<i>Overall: 33.5"w 37"d 47"h</i>				<i>Arm: 26"h</i>				<i>COM: 5.75 yds.</i>				
			<i>Seat: 28.5"w 20"d 20"h</i>				<i>Weight: 155 lbs.</i>				<i>COL: n/a</i>				
			COM	COL	1	2	3	4	5	6	7	8	9	10	L1
	1868-XE	3939	N/A	4146	4330	4513	4697	4881	5065	5248	5432	5616	5800	N/A	N/A
		<i>Tight Seat & Back / Removable Upholstery / 500 lb. Weight Capacity</i>													
	1868-XER	366	N/A	694	868	1042	1216	1389	1563	1737	1911	2085	2259	N/A	N/A
		<i>Replacement Upholstery Covers</i>													
	THREE POSITION RECLINER / DROP-DOWN ARM / URETHANE TASK ARM CAP		<i>Overall: 28.5"w 37"d 47"h</i>				<i>Arm: 26"h</i>				<i>COM: 5.5 yds.</i>				
			<i>Seat: 23.5"w 20"d 20"h</i>				<i>Weight: 125 lbs.</i>				<i>COL: n/a</i>				
			COM	COL	1	2	3	4	5	6	7	8	9	10	L1
	1860	4337	N/A	4434	4601	4768	4935	5102	5269	5436	5603	5770	5937	N/A	N/A
		<i>Tight Seat & Back / Removable Upholstery / 350 lb. Weight Capacity</i>													
	1860-R	348	N/A	677	850	1024	1198	1372	1546	1720	1894	2068	2241	N/A	N/A
		<i>Replacement Upholstery Covers</i>													
	BARIATRIC THREE POSITION RECLINER / DROP-DOWN ARM / URETHANE TASK ARM CAP		<i>Overall: 33.5"w 37"d 47"h</i>				<i>Arm: 26"h</i>				<i>COM: 5.75 yds.</i>				
			<i>Seat: 28.5"w 20"d 20"h</i>				<i>Weight: 140 lbs.</i>				<i>COL: n/a</i>				
			COM	COL	1	2	3	4	5	6	7	8	9	10	L1
	1860-X	4457	N/A	4581	4765	4949	5132	5316	5500	5684	5867	6051	6235	N/A	N/A
		<i>Tight Seat & Back / Removable Upholstery / 500 lb. Weight Capacity</i>													
	1860-XR	355	N/A	683	857	1031	1205	1378	1552	1726	1900	2074	2248	N/A	N/A
		<i>Replacement Upholstery Covers</i>													

WEIGHT-ACTIVATED MEDICAL RECLINER POSITIONS:

Fully Upholstered Arm Recliner Positions

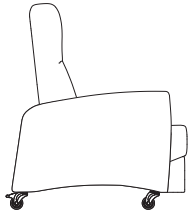

Upright Position
28.5°D

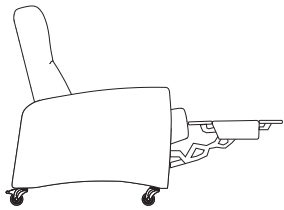

Extended Footrest Position
55.5°D

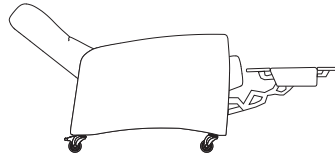

Layflat Position
67°D

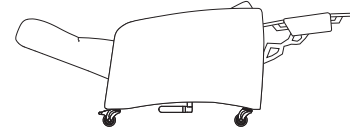

Trendelenburg Position
69°D

Drop-Down Arm Recliner Positions

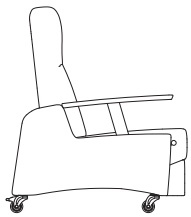

Upright Position
28.5°D

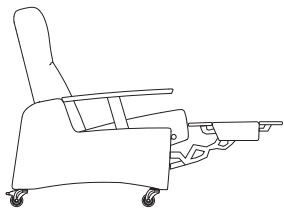

Extended Footrest Position
55.5°D

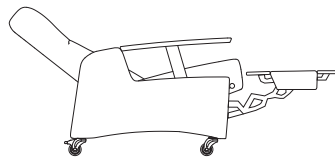

Layflat Position
67°D

PUSH BAR / IV / SIDE TRAY / BAG HOLDER / RESTRAINT BUCKLE	OPTION #:	SPECIFICATIONS LIST PRICES AVAILABILITY:
<p>PUSH BAR</p> 	<p>PB</p> <p>\$267 <i>(Black Finish)</i></p> <p>Available: <i>Facelift Evolve Weight Activated Medical Recliners</i></p>	
<p>I.V. POLE</p> 	<p>IV</p> <p>\$489 <i>Height Adjustable I.V. Pole (Chrome / Black Finish)</i></p> <p>Available: <i>Facelift Evolve Weight Activated Medical Recliners</i></p>	
<p>SIDE TRAY</p> 	<p>ST-1 \$368 <i>Drop-Down Side Tray (Small Side Tray)</i></p> <p>ST-2 \$415 <i>Drop-Down Side Tray (Large Side Tray)</i></p> <p>Available: <i>Facelift Evolve Weight Activated Medical Recliners</i></p>	
<p>BAG HOLDER / PERSONAL RESTRAINT BUCKLE</p> 	<p>BH \$86 <i>Bag Holder (Brushed Finish / Specify Left Or Right Facing Location)</i></p> <p>RB \$133 (Set Of 2) <i>Personal Restraint Buckle (Brushed Finish)</i></p> <p>Available: <i>Facelift Evolve Weight Activated Medical Recliners</i></p>	

OXYGEN TANK HOLDER / ARM CAPS / CASTERS	OPTION #:	SPECIFICATIONS LIST PRICES AVAILABILITY:
<p>OXYGEN TANK HOLDER</p> 	<p>OH</p> <p>\$247 <i>Black Metal Oxygen Tank Holder Holds a 4.375" Diameter Oxygen Tank (Not Included)</i></p> <p>Available: Facelift Evolve Weight Activated Medical Recliners</p>	
<p>SOLID WOOD / URETHANE ARM CAPS</p>  	<p>EWAC-1 \$243 (Set Of 2) WOOD <i>(Specify Finish)</i></p> <p>Available: 1858 Models Only</p> <p>EUAC-1 \$249 (Set Of 2) URETHANE <i>(Black Urethane)</i></p> <p>Available: 1858 Models Only</p>	
<p>POLYESTER ARM CAPS</p>  	<p>Overall: 2.75"w 22.5"d 1.125"h (EPAC-1) / 2.75"w 29"d 1.125"h (EPAC-2)</p> <p>EPAC-1 \$374 (Set Of 2) POLYESTER <i>(1860-U / 1860-XU / 1860-TU / 1860-XTU)</i></p> <p><i>Black Polyester Arm Cap (Additional Colors Available)</i></p> <p>EPAC-2 \$393 (Set Of 2) POLYESTER <i>(1858 / 1858-X / 1858-T / 1858-XT)</i> <i>(1859-U / 1859-XU / 1859-TU / 1859-XTU)</i> <i>(1859N-U / 1859N-XU / 1859N-TU / 1859N-XTU)</i></p> <p><i>Black Polyester Arm Cap (Additional Colors Available)</i></p>	
<p>MEDICAL LOCKING / NON-LOCKING CASTERS</p>   <p>Locking Casters</p> <p>Non-Locking Casters</p>	<p>Overall: 2.25"w 5"d 5.25"h (Locking) / 2"w 3.75"d 5.25"h (Non-Locking)</p> <p>MLC \$194 (Set Of Two) <i>Locking Casters - Motion & Direction (Gray Finish / Specify Location)</i></p> <p>MNLC \$224 (Set Of Two) <i>Non-Locking Casters - Single Direction (Gray Finish / Specify Location)</i></p> <p>Available: Facelift Evolve Weight Activated Medical Recliners</p>	

COVERS	OPTION #:	SPECIFICATIONS LIST PRICES AVAILABILITY:
<p>CONTRASTING COVERS</p> 	<p>Overall: N/A</p> <hr/> <p>CC \$129 <i>NOTE: If Two Or More Upholsteries Or Leathers Are Used On Any Piece Of Furniture, Then A Contrast Charge Will Apply Per Order. When Using Trinity Upholstery, The Higher Priced Upholstery Grade Will Be Used In Pricing, Unless It's Trinity Leather With Fabric Contrast Welt, Or COM With Trinity Contrast Welt, Then Contact Customer Service For Pricing.</i></p> <p>Available: <i>Facelift Evolve Weight Activated Medical Recliners</i></p>	

Facelift Evolve

LOUNGE / TANDEM

Effective: March 1, 2025

T R I N I T Y

Date:

Page:

Modification:

Description:

DESCRIPTION:

- Upholstery Frames: Steel, Plywood & Hardwood
- Seat: High Density Polyurethane Foam Over Strap Webbing
- Back: High Density Polyurethane Foam Over Sinuous Wire Springs
- Upholstered Covers: Attached w/ Velcro / Removable For Maintenance
- Exposed Wood Legs: Solid Hardwood / Removable For Maintenance
- Antimicrobial Moisture Barrier Fully Encapsulates All Foam Areas
- Leather Upholstery Not Available
- Lifetime Warranty

OPTIONS:

- EWAC Solid Wood Arm Caps (Set Of 2)\$243
 - EUAC Black Urethane Arm Caps (Set Of 2).....\$249
 - EPAC-2 Black Polyester Arm Caps (Set Of 2).....\$374
 - ARL Brushed Aluminum Round Legs (Set Of 4).....\$353
 - PM1 Power/Data Module (1-Power / 1-USB 2 Port Simplex Charger)\$859
- (Additional Power/Data Modules Available - See Evolve Options)

Feather Down & Polyester Pillows Available (See Page 5)
 Specify Exposed Wood Finish (See Page 6)
 Tablet Arm / Cup Holder Options (See Facelift Evolve Lounge / Tandem Options Pages)
NOTE: All Seating Configurations Are Viewed From Left To Right Facing. Please Attach A Layout Showing Seating Configuration w/ Your Order. Assembled Units Must Be Shipped In Configurations Of 3 Or Less.

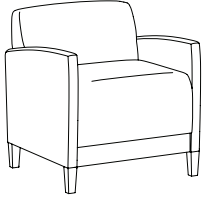
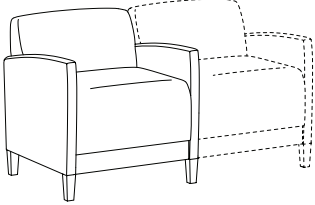
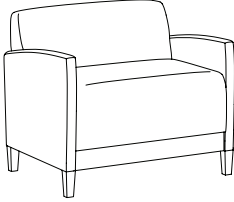
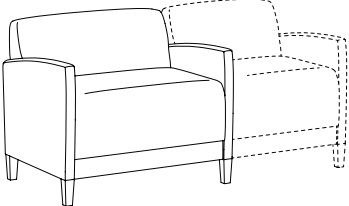
LOUNGE / TANDEM		ITEM #:	SPECIFICATIONS GRADES LIST PRICES:													
		1841	Overall: 28"w 29"d 31.5"h			Arm: 24.5"h			COM: 4.5 yds.							
			Seat: 23.5"w 19"d 18.5"h			Weight: 85 lbs.			COL: n/a							
			COM	COL	1	2	3	4	5	6	7	8	9	10	L1	L2
			1622	N/A	1779	1902	2024	2147	2270	2392	2515	2638	2760	2883	N/A	N/A
			<i>Tight Seat & Back / Removable Upholstery / 500 lb. Weight Capacity</i>													
		1841-R	251	N/A	491	617	744	870	996	1123	1249	1376	1502	1629	N/A	N/A
			<i>Replacement Upholstery Covers</i>													
		1841-C	Overall: 28"w 29"d 31.5"h			Arm: 24.5"h			COM: 4.5 yds.							
			Seat: 23.5"w 19"d 18.5"h			Weight: 85 lbs.			COL: n/a							
			COM	COL	1	2	3	4	5	6	7	8	9	10	L1	L2
			1622	N/A	1779	1902	2024	2147	2270	2392	2515	2638	2760	2883	N/A	N/A
			<i>Tight Seat & Back / Removable Upholstery / 500 lb. Weight Capacity</i>													
		1841-R	251	N/A	491	617	744	870	996	1123	1249	1376	1502	1629	N/A	N/A
			<i>Replacement Upholstery Covers</i>													
		1841-X	Overall: 34"w 29"d 31.5"h			Arm: 24.5"h			COM: 5 yds.							
			Seat: 29.5"w 19"d 18.5"h			Weight: 100 lbs.			COL: n/a							
			COM	COL	1	2	3	4	5	6	7	8	9	10	L1	L2
			1970	N/A	2137	2274	2411	2548	2685	2823	2960	3097	3234	3371	N/A	N/A
			<i>Tight Seat & Back / Removable Upholstery / 1000 lb. Weight Capacity</i>													
		1841-XR	258	N/A	529	671	813	955	1098	1240	1382	1524	1667	1809	N/A	N/A
			<i>Replacement Upholstery Covers</i>													
		1841-XC	Overall: 34"w 29"d 31.5"h			Arm: 24.5"h			COM: 5 yds.							
			Seat: 29.5"w 19"d 18.5"h			Weight: 100 lbs.			COL: n/a							
			COM	COL	1	2	3	4	5	6	7	8	9	10	L1	L2
			1970	N/A	2137	2274	2411	2548	2685	2823	2960	3097	3234	3371	N/A	N/A
			<i>Tight Seat & Back / Removable Upholstery / 1000 lb. Weight Capacity</i>													
		1841-XR	258	N/A	529	671	813	955	1098	1240	1382	1524	1667	1809	N/A	N/A
			<i>Replacement Upholstery Covers</i>													

DESCRIPTION:

- Upholstery Frames: Steel, Plywood & Hardwood
- Seat: High Density Polyurethane Foam Over Strap Webbing
- Back: High Density Polyurethane Foam Over Sinuous Wire Springs
- Upholstered Covers: Attached w/ Velcro / Removable For Maintenance
- Exposed Wood Legs: Solid Hardwood / Removable For Maintenance
- Antimicrobial Moisture Barrier Fully Encapsulates All Foam Areas
- Leather Upholstery Not Available
- Lifetime Warranty

OPTIONS:

- EWAC Solid Wood Arm Caps (Set Of 2)\$243
 - EUAC Black Urethane Arm Caps (Set Of 2).....\$249
 - EPAC-2 Black Polyester Arm Caps (Set Of 2).....\$374
 - ARL Brushed Aluminum Round Legs (Set Of 4).....\$353
 - PM1 Power/Data Module (1-Power / 1-USB 2 Port Simplex Charger)\$859
- (Additional Power/Data Modules Available - See Evolve Options)

Feather Down & Polyester Pillows Available (See Page 5)
 Specify Exposed Wood Finish (See Page 6)
 Tablet Arm / Cup Holder Options (See Facelift Evolve Lounge / Tandem Options Pages)
NOTE: All Seating Configurations Are Viewed From Left To Right Facing. Please Attach A Layout Showing Seating Configuration w/ Your Order. Assembled Units Must Be Shipped In Configurations Of 3 Or Less.

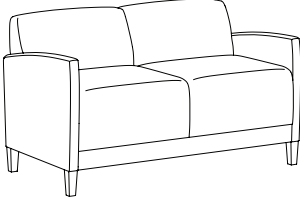
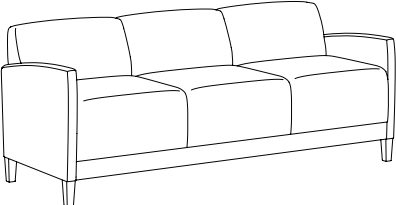
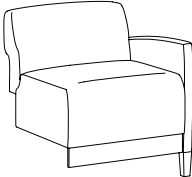
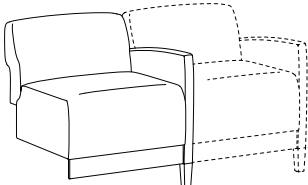
LOUNGE / TANDEM		ITEM #:	SPECIFICATIONS GRADES LIST PRICES:													
	TWO PLACE SOFA / FULLY UPHOLSTERED		Overall: 52"w 29"d 31.5"h				Arm: 24.5"h				COM: 6.75 yds.					
	Seat: 47.5"w 19"d 18.5"h				Weight: 135 lbs.				COL: n/a							
		COM	COL	1	2	3	4	5	6	7	8	9	10	L1	L2	
	1842	2531	N/A	2768	2956	3144	3331	3519	3706	3894	4082	4269	4457	N/A	N/A	
<i>Tight Seat & Back / Removable Upholstery / 1000 lb. Weight Capacity</i>																
	1842-R	373	N/A	764	969	1175	1380	1586	1791	1997	2202	2407	2613	N/A	N/A	
<i>Replacement Upholstery Covers</i>																
	THREE PLACE SOFA / FULLY UPHOLSTERED		Overall: 76"w 29"d 31.5"h				Arm: 24.5"h				COM: 8.5 yds.					
	Seat: 71.5"w 19"d 18.5"h				Weight: 180 lbs.				COL: n/a							
		COM	COL	1	2	3	4	5	6	7	8	9	10	L1	L2	
	1843	3440	N/A	3728	3967	4205	4443	4681	4919	5157	5395	5633	5872	N/A	N/A	
<i>Tight Seat & Back / Removable Upholstery / 1000 lb. Weight Capacity</i>																
	1843-R	481	N/A	992	1261	1530	1798	2067	2336	2604	2873	3142	3411	N/A	N/A	
<i>Replacement Upholstery Covers</i>																
	FULLY UPHOLSTERED / ADD-A-SEAT		Overall: 26"w 29"d 31.5"h				Arm: 24.5"h				COM: 4.25 yds.					
	Seat: 23.5"w 19"d 18.5"h				Weight: 65 lbs.				COL: n/a							
		COM	COL	1	2	3	4	5	6	7	8	9	10	L1	L2	
	1844	1325	N/A	1469	1577	1686	1794	1902	2010	2119	2227	2335	2443	N/A	N/A	
<i>Tight Seat & Back / Removable Upholstery / 500 lb. Weight Capacity</i>																
	1844-R	207	N/A	401	504	606	709	812	915	1017	1120	1223	1326	N/A	N/A	
<i>Replacement Upholstery Covers</i>																
	LOUNGE CHAIR / FULLY UPHOLSTERED / ADD-A-SEAT / ACCEPTS SEAT ON RIGHT		Overall: 26"w 29"d 31.5"h				Arm: 24.5"h				COM: 4.25 yds.					
	Seat: 23.5"w 19"d 18.5"h				Weight: 65 lbs.				COL: n/a							
		COM	COL	1	2	3	4	5	6	7	8	9	10	L1	L2	
	1844-C	1325	N/A	1469	1577	1686	1794	1902	2010	2119	2227	2335	2443	N/A	N/A	
<i>Tight Seat & Back / Removable Upholstery / 500 lb. Weight Capacity</i>																
	1844-CR	207	N/A	401	504	606	709	812	915	1017	1120	1223	1326	N/A	N/A	
<i>Replacement Upholstery Covers</i>																

DESCRIPTION:

- Upholstery Frames: Steel, Plywood & Hardwood
- Seat: High Density Polyurethane Foam Over Strap Webbing
- Back: High Density Polyurethane Foam Over Sinuous Wire Springs
- Upholstered Covers: Attached w/ Velcro / Removable For Maintenance
- Exposed Wood Arms: Solid Hardwood / Removable For Maintenance
- Antimicrobial Moisture Barrier Fully Encapsulates All Foam Areas
- Leather Upholstery Not Available
- Lifetime Warranty

OPTIONS:

- EWAC Solid Wood Arm Caps (Set Of 2)\$243
 - EUAC Black Urethane Arm Caps (Set Of 2).....\$249
 - EPAC-2 Black Polyester Arm Caps (Set Of 2).....\$374
 - ARL Brushed Aluminum Round Legs (Set Of 4).....\$353
 - PM1 Power/Data Module (1-Power / 1-USB 2 Port Simplex Charger)\$859
- (Additional Power/Data Modules Available - See Evolve Options)

Feather Down & Polyester Pillows Available (See Page 5)
 Specify Exposed Wood Finish (See Page 6)
 Tablet Arm / Cup Holder Options (See Facelift Evolve Lounge / Tandem Options Pages)
NOTE: All Seating Configurations Are Viewed From Left To Right Facing. Please Attach A Layout Showing Seating Configuration w/ Your Order. Assembled Units Must Be Shipped In Configurations Of 3 Or Less.

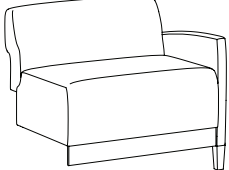
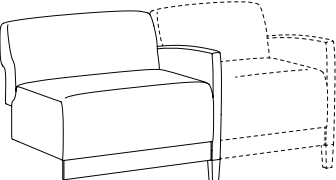
LOUNGE / TANDEM		ITEM #:	SPECIFICATIONS GRADES LIST PRICES:													
		BARIATRIC ADD-A-SEAT / FULLY UPHOLSTERED	Overall: 32"w 29"d 31.5"h Seat: 29.5"w 19"d 18.5"h			Arm: 24.5"h Weight: 80 lbs.			COM: 4.5 yds. COL: n/a							
			COM	COL	1	2	3	4	5	6	7	8	9	10	L1	L2
			1844-X	1652	N/A	1778	1886	1995	2103	2211	2319	2427	2536	2644	2752	N/A
<i>Tight Seat & Back / Removable Upholstery / 1000 lb. Weight Capacity</i>																
		1844-XR	213	N/A	439	557	676	795	913	1032	1150	1269	1387	1506	N/A	N/A
<i>Replacement Upholstery Covers</i>																
		BARIATRIC ADD-A-SEAT / FULLY UPHOLSTERED / ACCEPTS SEAT ON RIGHT	Overall: 32"w 29"d 31.5"h Seat: 29.5"w 19"d 18.5"h			Arm: 24.5"h Weight: 80 lbs.			COM: 4.5 yds. COL: n/a							
			COM	COL	1	2	3	4	5	6	7	8	9	10	L1	L2
			1844-XC	1652	N/A	1778	1886	1995	2103	2211	2319	2427	2536	2644	2752	N/A
<i>Tight Seat & Back / Removable Upholstery / 1000 lb. Weight Capacity</i>																
		1844-XR	213	N/A	439	557	676	795	913	1032	1150	1269	1387	1506	N/A	N/A
<i>Replacement Upholstery Covers</i>																

DESCRIPTION:

- Upholstery Frames: Steel, Plywood & Hardwood
- Seat: High Density Polyurethane Foam Over Strap Webbing
- Back: High Density Polyurethane Foam Over Sinuous Wire Springs
- Upholstered Covers: Attached w/ Velcro / Removable For Maintenance
- Exposed Wood Arms: Solid Hardwood / Removable For Maintenance
- Antimicrobial Moisture Barrier Fully Encapsulates All Foam Areas
- Leather Upholstery Not Available
- Lifetime Warranty

OPTIONS:

- Closed Arm Panels (1861-PL / 1861-PR / 1861-PC)..... CALL FOR PRICING
- Feather Down & Polyester Pillows Available (See Page 5)
- Specify Exposed Wood Finish (See Page 6)

NOTE: All Seating Configurations Are Viewed From Left To Right Facing. Please Attach A Layout Showing Seating Configuration w/ Your Order. Assembled Units Must Be Shipped In Configurations Of 3 Or Less.

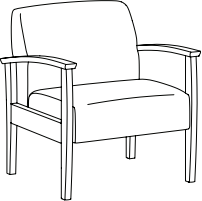
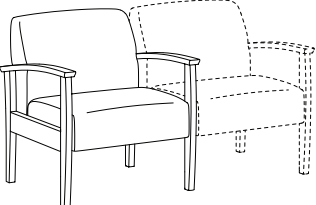
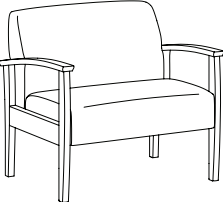
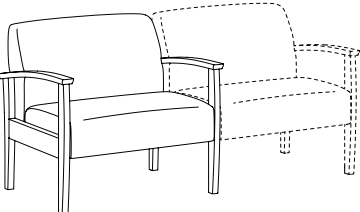
OPEN ARM LOUNGE / TANDEM		ITEM #:	SPECIFICATIONS GRADES LIST PRICES:													
	LOUNGE CHAIR / OPEN WOOD ARMS		Overall: 28.5"w 29.5"d 32"h Seat: 24"w 19.5"d 18.5"h			Arm: 24.5"h Weight: 65 lbs.			COM: 2.5 yds. COL: n/a							
			COM	COL	1	2	3	4	5	6	7	8	9	10	L1	L2
	1861		1575	N/A	1619	1684	1749	1814	1879	1944	2009	2074	2139	2203	N/A	N/A
		<i>Tight Seat & Back / Removable Upholstery / 500 lb. Weight Capacity</i>														
	1861-R	190	N/A	322	393	464	535	606	677	748	820	891	962	N/A	N/A	
		<i>Replacement Upholstery Covers</i>														
	LOUNGE CHAIR / OPEN WOOD ARMS / ACCEPTS SEAT ON RIGHT		Overall: 28.5"w 29.5"d 32"h Seat: 24"w 19.5"d 18.5"h			Arm: 24.5"h Weight: 65 lbs.			COM: 2.5 yds. COL: n/a							
			COM	COL	1	2	3	4	5	6	7	8	9	10	L1	L2
	1861-C		1575	N/A	1619	1684	1749	1814	1879	1944	2009	2074	2139	2203	N/A	N/A
		<i>Tight Seat & Back / Removable Upholstery / 500 lb. Weight Capacity</i>														
	1861-R	190	N/A	322	393	464	535	606	677	748	820	891	962	N/A	N/A	
		<i>Replacement Upholstery Covers</i>														
	BARIATRIC LOUNGE CHAIR / OPEN WOOD ARMS		Overall: 34.5"w 29.5"d 32"h Seat: 30"w 19.5"d 18.5"h			Arm: 24.5"h Weight: 80 lbs.			COM: 3 yds. COL: n/a							
			COM	COL	1	2	3	4	5	6	7	8	9	10	L1	L2
	1861-X		1899	N/A	1954	2033	2113	2192	2271	2351	2430	2509	2589	2668	N/A	N/A
		<i>Tight Seat & Back / Removable Upholstery / 750 lb. Weight Capacity</i>														
	1861-XR	196	N/A	360	446	533	620	707	794	881	968	1055	1142	N/A	N/A	
		<i>Replacement Upholstery Covers</i>														
	BARIATRIC LOUNGE CHAIR / OPEN WOOD ARMS / ACCEPTS SEAT ON RIGHT		Overall: 34.5"w 29.5"d 32"h Seat: 30"w 19.5"d 18.5"h			Arm: 24.5"h Weight: 80 lbs.			COM: 3 yds. COL: n/a							
			COM	COL	1	2	3	4	5	6	7	8	9	10	L1	L2
	1861-XC		1899	N/A	1954	2033	2113	2192	2271	2351	2430	2509	2589	2668	N/A	N/A
		<i>Tight Seat & Back / Removable Upholstery / 750 lb. Weight Capacity</i>														
	1861-XR	196	N/A	360	446	533	620	707	794	881	968	1055	1142	N/A	N/A	
		<i>Replacement Upholstery Covers</i>														

DESCRIPTION:

- Upholstery Frames: Steel, Plywood & Hardwood
- Seat: High Density Polyurethane Foam Over Strap Webbing
- Back: High Density Polyurethane Foam Over Sinuous Wire Springs
- Upholstered Covers: Attached w/ Velcro / Removable For Maintenance
- Exposed Wood Arms: Solid Hardwood / Removable For Maintenance
- Antimicrobial Moisture Barrier Fully Encapsulates All Foam Areas
- Leather Upholstery Not Available
- Lifetime Warranty

OPTIONS:

Closed Arm Panels (1861-PL / 1861-PR / 1861-PC)..... CALL FOR PRICING

Feather Down & Polyester Pillows Available (See Page 5)
Specify Exposed Wood Finish (See Page 6)

NOTE: All Seating Configurations Are Viewed From Left To Right Facing. Please Attach A Layout Showing Seating Configuration w/ Your Order. Assembled Units Must Be Shipped In Configurations Of 3 Or Less.

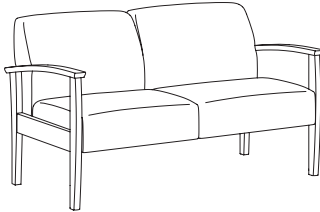
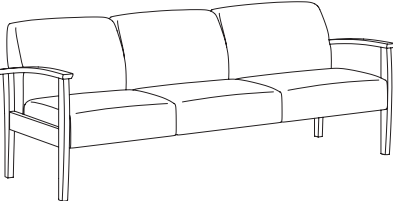
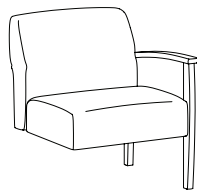
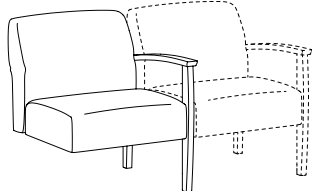
OPEN ARM LOUNGE / TANDEM		ITEM #:	SPECIFICATIONS GRADES LIST PRICES:													
TWO PLACE SOFA / OPEN WOOD ARMS			Overall: 52.5"w 29.5"d 32"h			Arm: 24.5"h			COM: 4.75 yds.							
			Seat: 48"w 19.5"d 18.5"h			Weight: 140 lbs.			COL: n/a							
			COM	COL	1	2	3	4	5	6	7	8	9	10	L1	L2
	1862		2457	N/A	2583	2713	2843	2973	3102	3232	3362	3492	3622	3752	N/A	N/A
<i>Tight Seat & Back / Removable Upholstery / 750 lb. Weight Capacity</i>																
	1862-R		294	N/A	563	705	847	989	1132	1274	1416	1558	1701	1843	N/A	N/A
<i>Replacement Upholstery Covers</i>																
THREE PLACE SOFA / OPEN WOOD ARMS			Overall: 76.5"w 29.5"d 32"h			Arm: 24.5"h			COM: 7 yds.							
			Seat: 72"w 19.5"d 18.5"h			Weight: 180 lbs.			COL: n/a							
			COM	COL	1	2	3	4	5	6	7	8	9	10	L1	L2
	1863		3055	N/A	3278	3473	3668	3863	4058	4252	4447	4642	4837	5032	N/A	N/A
<i>Tight Seat & Back / Removable Upholstery / 750 lb. Weight Capacity</i>																
	1863-R		382	N/A	788	1001	1215	1428	1641	1855	2068	2281	2495	2708	N/A	N/A
<i>Replacement Upholstery Covers</i>																
ADD-A-SEAT / OPEN WOOD ARMS			Overall: 26.5"w 29.5"d 32"h			Arm: 24.5"h			COM: 2.5 yds.							
			Seat: 24"w 19.5"d 18.5"h			Weight: 60 lbs.			COL: n/a							
			COM	COL	1	2	3	4	5	6	7	8	9	10	L1	L2
	1864		1261	N/A	1322	1387	1452	1517	1582	1647	1712	1777	1842	1907	N/A	N/A
<i>Tight Seat & Back / Removable Upholstery / 500 lb. Weight Capacity</i>																
	1864-R		190	N/A	322	393	464	535	606	677	748	820	891	962	N/A	N/A
<i>Replacement Upholstery Covers</i>																
ADD-A-SEAT / OPEN WOOD ARMS / ACCEPTS SEAT ON RIGHT			Overall: 26.5"w 29.5"d 32"h			Arm: 24.5"h			COM: 2.5 yds.							
			Seat: 24"w 19.5"d 18.5"h			Weight: 60 lbs.			COL: n/a							
			COM	COL	1	2	3	4	5	6	7	8	9	10	L1	L2
	1864-C		1261	N/A	1322	1387	1452	1517	1582	1647	1712	1777	1842	1907	N/A	N/A
<i>Tight Seat & Back / Removable Upholstery / 500 lb. Weight Capacity</i>																
	1864-R		190	N/A	322	393	464	535	606	677	748	820	891	962	N/A	N/A
<i>Replacement Upholstery Covers</i>																

DESCRIPTION:

- Upholstery Frames: Steel, Plywood & Hardwood
- Seat: High Density Polyurethane Foam Over Strap Webbing
- Back: High Density Polyurethane Foam Over Sinuous Wire Springs
- Upholstered Covers: Attached w/ Velcro / Removable For Maintenance
- Exposed Wood Arms: Solid Hardwood / Removable For Maintenance
- Antimicrobial Moisture Barrier Fully Encapsulates All Foam Areas
- Leather Upholstery Not Available
- Lifetime Warranty

OPTIONS:

- Closed Arm Panels (1861-PL / 1861-PR / 1861-PC)..... CALL FOR PRICING
- Feather Down & Polyester Pillows Available (See Page 5)
- Specify Exposed Wood Finish (See Page 6)

NOTE: All Seating Configurations Are Viewed From Left To Right Facing. Please Attach A Layout Showing Seating Configuration w/ Your Order. Assembled Units Must Be Shipped In Configurations Of 3 Or Less.

OPEN ARM LOUNGE / TANDEM

ITEM #:

SPECIFICATIONS | GRADES | LIST PRICES:

BARIATRIC ADD-A-SEAT / OPEN WOOD ARMS

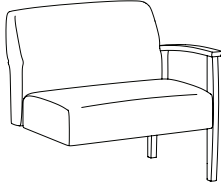

Overall: 32.5"w 29.5"d 32"h **Arm:** 24.5"h **COM:** 3 yds.
Seat: 30"w 19.5"d 18.5"h **Weight:** 75 lbs. **COL:** n/a

COM	COL	1	2	3	4	5	6	7	8	9	10	L1	L2
1864-X	N/A	1669	1748	1827	1907	1986	2065	2145	2224	2304	2383	N/A	N/A
<i>Tight Seat & Back / Removable Upholstery / 750 lb. Weight Capacity</i>													
1864-XR	N/A	360	446	533	620	707	794	881	968	1055	1142	N/A	N/A
<i>Replacement Upholstery Covers</i>													

BARIATRIC ADD-A-SEAT / OPEN WOOD ARMS / ACCEPTS SEAT ON RIGHT

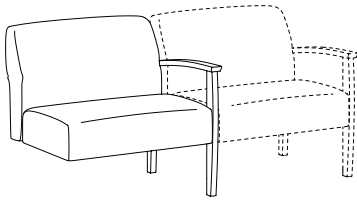

Overall: 32.5"w 29.5"d 32"h **Arm:** 24.5"h **COM:** 3 yds.
Seat: 30"w 19.5"d 18.5"h **Weight:** 75 lbs. **COL:** n/a

COM	COL	1	2	3	4	5	6	7	8	9	10	L1	L2
1864-XC	N/A	1669	1748	1827	1907	1986	2065	2145	2224	2304	2383	N/A	N/A
<i>Tight Seat & Back / Removable Upholstery / 750 lb. Weight Capacity</i>													
1864-XR	N/A	360	446	533	620	707	794	881	968	1055	1142	N/A	N/A
<i>Replacement Upholstery Covers</i>													

DESCRIPTION:

- Upholstery Frames: Steel, Plywood & Hardwood
- Seat: High Density Polyurethane Foam Over Strap Webbing
- Back: High Density Polyurethane Foam Over Sinuous Wire Springs
- Upholstered Covers: Attached w/ Velcro / Removable For Maintenance
- Exposed Wood Arms: Solid Hardwood / Removable For Maintenance
- Antimicrobial Moisture Barrier Fully Encapsulates All Foam Areas
- Leather Upholstery Not Available
- Lifetime Warranty

OPTIONS:

- EPAC-2 Black Polyester Arm Caps (Set Of 2).....\$374
- Closed Arm Panels (1861-PL / 1861-PR / 1861-PC)..... CALL FOR PRICING
- Feather Down & Polyester Pillows Available (See Page 5)
- Specify Exposed Wood Finish (See Page 6)

NOTE: All Seating Configurations Are Viewed From Left To Right Facing. Please Attach A Layout Showing Seating Configuration w/ Your Order. Assembled Units Must Be Shipped In Configurations Of 3 Or Less.

OPEN ARM LOUNGE / TANDEM

ITEM #:

SPECIFICATIONS | GRADES | LIST PRICES:

LOUNGE CHAIR / OPEN URETHANE ARMS

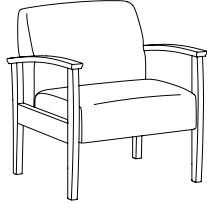

		Overall: 28.5"w 29.5"d 32"h		Arm: 24.5"h		COM: 2.5 yds.							
		Seat: 24"w 19.5"d 18.5"h		Weight: 65 lbs.		COL: n/a							
COM	COL	1	2	3	4	5	6	7	8	9	10	L1	L2
1871	N/A	1659	1724	1789	1854	1919	1984	2049	2114	2179	2244	N/A	N/A
<i>Tight Seat & Back / Removable Upholstery / 500 lb. Weight Capacity</i>													
1871-R	N/A	322	393	464	535	606	677	748	820	891	962	N/A	N/A
<i>Replacement Upholstery Covers</i>													

LOUNGE CHAIR / OPEN URETHANE ARMS / ACCEPTS SEAT ON RIGHT

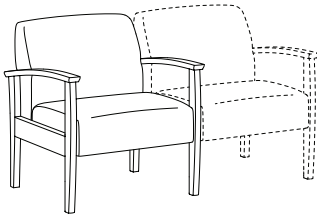

		Overall: 28.5"w 29.5"d 32"h		Arm: 24.5"h		COM: 2.5 yds.							
		Seat: 24"w 19.5"d 18.5"h		Weight: 65 lbs.		COL: n/a							
COM	COL	1	2	3	4	5	6	7	8	9	10	L1	L2
1871-C	N/A	1659	1724	1789	1854	1919	1984	2049	2114	2179	2244	N/A	N/A
<i>Tight Seat & Back / Removable Upholstery / 500 lb. Weight Capacity</i>													
1871-R	N/A	322	393	464	535	606	677	748	820	891	962	N/A	N/A
<i>Replacement Upholstery Covers</i>													

BIARTRIC LOUNGE CHAIR / OPEN URETHANE ARMS

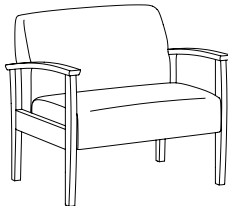

		Overall: 34.5"w 29.5"d 32"h		Arm: 24.5"h		COM: 3 yds.							
		Seat: 30"w 19.5"d 18.5"h		Weight: 80 lbs.		COL: n/a							
COM	COL	1	2	3	4	5	6	7	8	9	10	L1	L2
1871-X	N/A	2000	2079	2159	2238	2317	2397	2476	2556	2635	2714	N/A	N/A
<i>Tight Seat & Back / Removable Upholstery / 750 lb. Weight Capacity</i>													
1871-XR	N/A	360	446	533	620	707	794	881	968	1055	1142	N/A	N/A
<i>Replacement Upholstery Covers</i>													

BIARTRIC LOUNGE CHAIR / OPEN URETHANE ARMS / ACCEPTS SEAT ON RIGHT

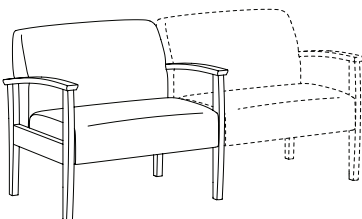

		Overall: 34.5"w 29.5"d 32"h		Arm: 24.5"h		COM: 3 yds.							
		Seat: 30"w 19.5"d 18.5"h		Weight: 80 lbs.		COL: n/a							
COM	COL	1	2	3	4	5	6	7	8	9	10	L1	L2
1871-XC	N/A	2000	2079	2159	2238	2317	2397	2476	2556	2635	2714	N/A	N/A
<i>Tight Seat & Back / Removable Upholstery / 750 lb. Weight Capacity</i>													
1871-XR	N/A	360	446	533	620	707	794	881	968	1055	1142	N/A	N/A
<i>Replacement Upholstery Covers</i>													

DESCRIPTION:

- Upholstery Frames: Steel, Plywood & Hardwood
- Seat: High Density Polyurethane Foam Over Strap Webbing
- Back: High Density Polyurethane Foam Over Sinuous Wire Springs
- Upholstered Covers: Attached w/ Velcro / Removable For Maintenance
- Exposed Wood Arms: Solid Hardwood / Removable For Maintenance
- Antimicrobial Moisture Barrier Fully Encapsulates All Foam Areas
- Leather Upholstery Not Available
- Lifetime Warranty

OPTIONS:

- EPAC-2 Black Polyester Arm Caps (Set Of 2).....\$374
- Closed Arm Panels (1861-PL / 1861-PR / 1861-PC)..... CALL FOR PRICING

Feather Down & Polyester Pillows Available (See Page 5)
Specify Exposed Wood Finish (See Page 6)

NOTE: All Seating Configurations Are Viewed From Left To Right Facing. Please Attach A Layout Showing Seating Configuration w/ Your Order. Assembled Units Must Be Shipped In Configurations Of 3 Or Less.

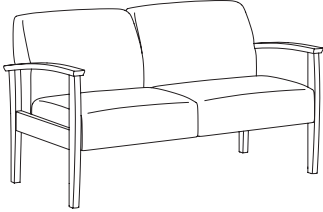
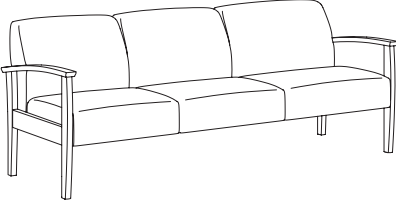
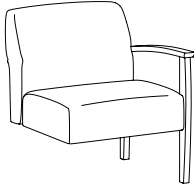
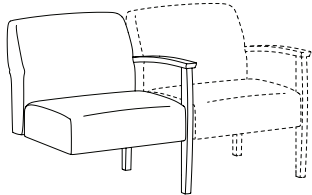
OPEN ARM LOUNGE / TANDEM		ITEM #:	SPECIFICATIONS GRADES LIST PRICES:													
TWO PLACE SOFA / OPEN URETHANE ARMS			<i>Overall: 52.5"w 29.5"d 32"h</i>			<i>Arm: 24.5"h</i>			<i>COM: 4.75 yds.</i>							
			<i>Seat: 48"w 19.5"d 18.5"h</i>			<i>Weight: 140 lbs.</i>			<i>COL: n/a</i>							
			COM	COL	1	2	3	4	5	6	7	8	9	10	L1	L2
	1872		2500	N/A	2623	2753	2883	3013	3143	3273	3403	3533	3662	3792	N/A	N/A
<i>Tight Seat & Back / Removable Upholstery / 750 lb. Weight Capacity</i>																
	1872-R		294	N/A	563	705	847	989	1132	1274	1416	1558	1701	1843	N/A	N/A
<i>Replacement Upholstery Covers</i>																
THREE PLACE SOFA / OPEN URETHANE ARMS			<i>Overall: 76.5"w 29.5"d 32"h</i>			<i>Arm: 24.5"h</i>			<i>COM: 7 yds.</i>							
			<i>Seat: 72"w 19.5"d 18.5"h</i>			<i>Weight: 180 lbs.</i>			<i>COL: n/a</i>							
			COM	COL	1	2	3	4	5	6	7	8	9	10	L1	L2
	1873		3104	N/A	3324	3519	3714	3909	4104	4299	4493	4688	4883	5078	N/A	N/A
<i>Tight Seat & Back / Removable Upholstery / 750 lb. Weight Capacity</i>																
	1873-R		382	N/A	788	1001	1215	1428	1641	1855	2068	2281	2495	2708	N/A	N/A
<i>Replacement Upholstery Covers</i>																
ADD-A-SEAT / OPEN URETHANE ARMS			<i>Overall: 26.5"w 29.5"d 32"h</i>			<i>Arm: 24.5"h</i>			<i>COM: 2.5 yds.</i>							
			<i>Seat: 24"w 19.5"d 18.5"h</i>			<i>Weight: 60 lbs.</i>			<i>COL: n/a</i>							
			COM	COL	1	2	3	4	5	6	7	8	9	10	L1	L2
	1874		1285	N/A	1345	1410	1475	1540	1605	1670	1735	1800	1865	1930	N/A	N/A
<i>Tight Seat & Back / Removable Upholstery / 500 lb. Weight Capacity</i>																
	1874-R		190	N/A	322	393	464	535	606	677	748	820	891	962	N/A	N/A
<i>Replacement Upholstery Covers</i>																
ADD-A-SEAT / OPEN URETHANE ARMS / ACCEPTS SEAT ON RIGHT			<i>Overall: 26.5"w 29.5"d 32"h</i>			<i>Arm: 24.5"h</i>			<i>COM: 2.5 yds.</i>							
			<i>Seat: 24"w 19.5"d 18.5"h</i>			<i>Weight: 60 lbs.</i>			<i>COL: n/a</i>							
			COM	COL	1	2	3	4	5	6	7	8	9	10	L1	L2
	1874-C		1285	N/A	1345	1410	1475	1540	1605	1670	1735	1800	1865	1930	N/A	N/A
<i>Tight Seat & Back / Removable Upholstery / 500 lb. Weight Capacity</i>																
	1874-R		190	N/A	322	393	464	535	606	677	748	820	891	962	N/A	N/A
<i>Replacement Upholstery Covers</i>																

DESCRIPTION:

- Upholstery Frames: Steel, Plywood & Hardwood
- Seat: High Density Polyurethane Foam Over Strap Webbing
- Back: High Density Polyurethane Foam Over Sinuous Wire Springs
- Upholstered Covers: Attached w/ Velcro / Removable For Maintenance
- Exposed Wood Arms: Solid Hardwood / Removable For Maintenance
- Antimicrobial Moisture Barrier Fully Encapsulates All Foam Areas
- Leather Upholstery Not Available
- Lifetime Warranty

OPTIONS:

EPAC-2 Black Polyester Arm Caps (Set Of 2).....\$374
 Closed Arm Panels (1861-PL / 1861-PR / 1861-PC)..... CALL FOR PRICING

Feather Down & Polyester Pillows Available (See Page 5)
 Specify Exposed Wood Finish (See Page 6)

NOTE: All Seating Configurations Are Viewed From Left To Right Facing. Please Attach A Layout Showing Seating Configuration w/ Your Order. Assembled Units Must Be Shipped In Configurations Of 3 Or Less.

OPEN ARM LOUNGE / TANDEM

ITEM #:

SPECIFICATIONS | GRADES | LIST PRICES:

BARIATRIC ADD-A-SEAT / OPEN URETHANE ARMS

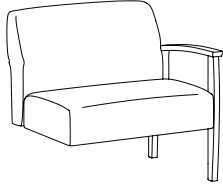



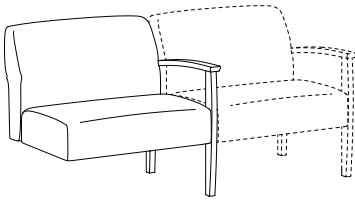

Overall: 32.5"w 29.5"d 32"h		Arm: 24.5"h		COM: 3 yds.									
Seat: 30"w 19.5"d 18.5"h		Weight: 75 lbs.		COL: n/a									
COM	COL	1	2	3	4	5	6	7	8	9	10	L1	L2
1615	N/A	1686	1765	1845	1924	2003	2083	2162	2241	2321	2400	N/A	N/A
<i>Tight Seat & Back / Removable Upholstery / 750 lb. Weight Capacity</i>													
1874-X													
196	N/A	360	446	533	620	707	794	881	968	1055	1142	N/A	N/A
<i>Replacement Upholstery Covers</i>													

BARIATRIC ADD-A-SEAT / OPEN URETHANE ARMS / ACCEPTS SEAT ON RIGHT



Overall: 32.5"w 29.5"d 32"h		Arm: 24.5"h		COM: 3 yds.									
Seat: 30"w 19.5"d 18.5"h		Weight: 75 lbs.		COL: n/a									
COM	COL	1	2	3	4	5	6	7	8	9	10	L1	L2
1615	N/A	1686	1765	1845	1924	2003	2083	2162	2241	2321	2400	N/A	N/A
<i>Tight Seat & Back / Removable Upholstery / 750 lb. Weight Capacity</i>													
1874-XC													
196	N/A	360	446	533	620	707	794	881	968	1055	1142	N/A	N/A
<i>Replacement Upholstery Covers</i>													

ARM CAPS / TABLETS	OPTION #:	SPECIFICATIONS LIST PRICES AVAILABILITY:
<p>SOLID WOOD ARM CAPS</p> 	<p>EWAC</p>	<p>Overall: 2.75"w 29"d 1.125"h</p> <hr/> <p>\$243 (Set Of 2) SOLID WOOD <i>(Specify Finish)</i></p> <p>Available: <i>Facelift Evolve Fully Upholstered Lounge & Tandem</i></p>
<p>URETHANE / POLYESTER ARM CAPS</p> 	<p>EUAC</p> <p>EPAC-2</p>	<p>Overall: 2.75"w 29"d 1.125"h</p> <hr/> <p>\$249 (Set Of 2) URETHANE <i>(1841-1844 Black Urethane)</i></p> <p>\$374 (Set Of 2) POLYESTER <i>(1841-1844 / 1871-1874)</i></p> <p><i>Black Polyester Arm Cap (Additional Colors Available)</i></p> <p>Available: <i>Facelift Evolve Fully Upholstered Lounge & Tandem</i></p>
<p>TABLET ARMS / CUP HOLDER</p>  <p>Laminate Tablet Arm Shown w/ Cup Holder</p> <p>Veneer Tablet Arm Shown w/ Cup Holder</p> <p>Solid Surface Tablet Arm Shown w/ Cup Holder</p>	<p>TA-L</p> <p>TA-V</p> <p>TA-C</p> <p>CH-1</p> <p>CH-2</p>	<p>Overall: 14" Diameter .75"h</p> <hr/> <p>\$509 <i>Tablet Arm With 360° Rotation - High Pressure Laminate. (Specify Laminate / Specify Left Or Right Facing Arm Location)</i></p> <p>\$580 <i>Tablet Arm With 360° Rotation - Sunburst Cherry Veneer. (Specify Finish / Specify Left Or Right Facing Arm Location)</i></p> <p>\$698 <i>Tablet Arm With 360° Rotation - White Solid Surface. (Available In White Only / Specify Left Or Right Facing Arm Location)</i></p> <p>\$129 <i>Black Plastic Cup Holder (Only Available If Used With Tablet Arm)</i></p> <p>\$186 <i>Spun Aluminum Cup Holder (Only Available If Used With Tablet Arm)</i></p> <p>Available: <i>Facelift Evolve Lounge / Tandem Collection</i></p>
<p>FOLD DOWN TABLET ARM</p> 	<p>FDTA-L</p> <p>FDTA-V</p> <p>FDTA-C</p>	<p>Overall: 14" Diameter .75"h</p> <hr/> <p>\$1065 <i>Tablet Arm With 360° Rotation - High Pressure Laminate. (Specify Laminate / Specify Left Or Right Facing Arm Location)</i></p> <p>\$1136 <i>Tablet Arm With 360° Rotation - Sunburst Cherry Veneer. (Specify Finish / Specify Left Or Right Facing Arm Location)</i></p> <p>\$1278 <i>Tablet Arm With 360° Rotation - White Solid Surface. (Available In White Only / Specify Left Or Right Facing Arm Location)</i></p> <p>Available: <i>Facelift Evolve Lounge / Tandem Collection</i></p>

TABLETS / POWER / LEGS / COVERS	OPTION #:	SPECIFICATIONS LIST PRICES AVAILABILITY:
<p>DOUBLE ARTICULATING / SWIVEL TABLET ARM</p>  <p>ATA-L Double Articulating / Swivel Tablet Arm</p>  <p>ATA-L w/ CH-1 Black Plastic Cup Holder</p>	<p>Overall: 14" Diameter .75"h</p> <hr/> <p>ATA-L \$983 <i>Tablet Arm With 360° Rotation - High Pressure Laminate. (Specify Laminate / Specify Left Or Right Facing Arm Location)</i></p> <p>ATA-V \$1055 <i>Tablet Arm With 360° Rotation - Sunburst Cherry Veneer. (Specify Finish / Specify Left Or Right Facing Arm Location)</i></p> <p>ATA-C \$1173 <i>Tablet Arm With 360° Rotation - White Solid Surface. (Available In White Only / Specify Left Or Right Facing Arm Location)</i></p> <p>CH-1 \$129 <i>Black Plastic Cup Holder (Only Available If Used With Tablet Arm)</i></p> <p>CH-2 \$186 <i>Spun Aluminum Cup Holder (Only Available If Used With Tablet Arm)</i></p> <p>Available: <i>Facelift Evolve Lounge / Tandem Collection</i></p>	
<p>POWER / DATA MODULE</p>  <p>PM1 Power / Data Module</p>  <p>PM2 Power Module</p>  <p>USB-1 Dual Charging USB</p>	<p>PM1 Overall: 5.25"w 1.25"d 4.25"h PM2 Overall: 2"w 2"d .125"h USB-1 Overall: 2"w 2"d .125"h</p> <hr/> <p>PM1 \$859 Power/Data Module (1-Power / 1-USB 2 Port Simplex Charger Standard) <i>Vertical / Horizontal Mount Power Module. Price Varies By Socket. Contact Customer Service For Quote. (Additional Colors Available)</i></p> <p>PM2 \$238 Power Module (1-Power) <i>Spill-Proof Technology / Multiple Finish Options / Storm Color Standard (Specify Left or Right Facing)</i></p> <p>USB-1 \$238 Dual Charging USB (2 Port Simplex Charger Standard) <i>Spill-Proof Technology / 2 Amps Per Port / Multiple Finish Options / Storm Color Standard (Specify Left or Right Facing)</i></p> <p>Available: <i>Facelift Evolve Fully Upholstered Lounge</i></p>	
<p>BRUSHED ALUMINUM ROUND LEGS</p> 	<p>Overall: 2" Diameter 5"h</p> <hr/> <p>ARL \$353 (Set Of 4) <i>(Brushed Aluminum Finish)</i></p> <p>Available: <i>Facelift Evolve Lounge & Tandem</i></p>	
<p>CONTRASTING COVERS</p> 	<p>Overall: N/A</p> <hr/> <p>CC \$129 <i>NOTE: If Two Or More Upholsteries Or Leathers Are Used On Any Piece Of Furniture, Then A Contrast Charge Will Apply Per Order. When Using Trinity Upholstery, The Higher Priced Upholstery Grade Will Be Used In Pricing, Unless It's Trinity Leather With Fabric Contrast Welt, Or COM With Trinity Contrast Welt, Then Contact Customer Service For Pricing.</i></p> <p>Available: <i>Facelift Evolve Lounge & Tandem</i></p>	

Facelift Evolve

FULLY UPHOLSTERED GUEST / TANDEM / TABLES

Effective: March 1, 2025

T R I N I T Y

Date:

Page:

Modification:

Description:

DESCRIPTION:

- Upholstery Frames: Steel, Plywood & Hardwood
- Seat: High Density Polyurethane Foam Over Strap Webbing
- Back: High Density Polyurethane Foam Over Plywood
- Upholstered Covers: Attached w/ Velcro / Removable For Maintenance
- Exposed Black Polyurethane Arm Caps Standard
- Exposed Black Polyester Legs Standard: Removable For Maintenance / Wallsaver Legs
- Antimicrobial Moisture Barrier Fully Encapsulates Seat & Back
- Leather Upholstery Not Available
- Adjustable Height Leveling Glides Standard
- Lifetime Warranty

OPTIONS:

- EPAC-1 Polyester Arm Cap (Specify Color)\$195 Each
- Specify Exposed Polyester Leg Finish (See Page 7)
- Table & Connecting Tables Available (See Facelift Evolve Guest/Tandem/Tables)

NOTE: All Seating Configurations Are Viewed From Left To Right Facing. Please Attach A Layout Showing Seating Configuration w/ Your Order. Assembled Units Must Be Shipped In Configurations Of 3 Or Less.

GUEST / TANDEM

ITEM #:

SPECIFICATIONS | GRADES | LIST PRICES:

FULLY UPHOLSTERED CHAIR

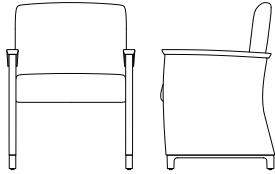

Overall: 23.5"w 24"d 34"h **Arm:** 25"h **COM:** 3.75 yds.
Seat: 20"w 19"d 18.5"h **Weight:** 55 lbs. **COL:** n/a

COM	COL	1	2	3	4	5	6	7	8	9	10	L1	L2
1880	N/A	1529	1626	1722	1818	1914	2010	2107	2203	2299	2395	N/A	N/A
<i>Closed Back / Tight Seat & Back / Removable Upholstery / 350 lb. Weight Capacity</i>													
1880-R	N/A	358	474	589	704	820	935	1057	1179	1302	1424	N/A	N/A
<i>Replacement Upholstery Covers</i>													

FULLY UPHOLSTERED CHAIR / ACCEPTS CHAIR ON RIGHT

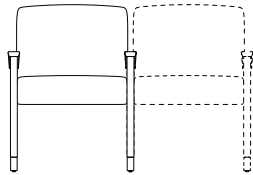

Overall: 23.5"w 24"d 34"h **Arm:** 25"h **COM:** 3.75 yds.
Seat: 20"w 19"d 18.5"h **Weight:** 55 lbs. **COL:** n/a

COM	COL	1	2	3	4	5	6	7	8	9	10	L1	L2
1880-C	N/A	1529	1626	1722	1818	1914	2010	2107	2203	2299	2395	N/A	N/A
<i>Closed Back / Tight Seat & Back / Removable Upholstery / 350 lb. Weight Capacity</i>													
1880-R	N/A	358	474	589	704	820	935	1057	1179	1302	1424	N/A	N/A
<i>Replacement Upholstery Covers</i>													

FULLY UPHOLSTERED CHAIR / ACCEPTS TABLE ON RIGHT

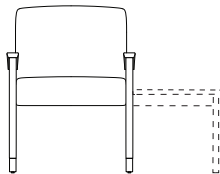

Overall: 23.5"w 24"d 34"h **Arm:** 25"h **COM:** 3.75 yds.
Seat: 20"w 19"d 18.5"h **Weight:** 55 lbs. **COL:** n/a

COM	COL	1	2	3	4	5	6	7	8	9	10	L1	L2
1880-T	N/A	1529	1626	1722	1818	1914	2010	2107	2203	2299	2395	N/A	N/A
<i>Closed Back / Tight Seat & Back / Removable Upholstery / 350 lb. Weight Capacity</i>													
1880-R	N/A	358	474	589	704	820	935	1057	1179	1302	1424	N/A	N/A
<i>Replacement Upholstery Covers</i>													

DESCRIPTION:

- Upholstery Frames: Steel, Plywood & Hardwood
- Seat: High Density Polyurethane Foam Over Strap Webbing
- Back: High Density Polyurethane Foam Over Plywood
- Upholstered Covers: Attached w/ Velcro / Removable For Maintenance
- Exposed Black Polyurethane Arm Caps Standard
- Exposed Black Polyester Legs Standard: Removable For Maintenance / Wallsaver Legs
- Antimicrobial Moisture Barrier Fully Encapsulates Seat & Back
- Leather Upholstery Not Available
- Adjustable Height Leveling Glides Standard
- Lifetime Warranty

OPTIONS:

- EPAC-1 Polyester Arm Cap (Specify Color)\$195 Each
- Specify Exposed Polyester Leg Finish (See Page 7)
- Table & Connecting Tables Available (See Facelift Evolve Guest/Tandem/Tables)

NOTE: All Seating Configurations Are Viewed From Left To Right Facing. Please Attach A Layout Showing Seating Configuration w/ Your Order. Assembled Units Must Be Shipped In Configurations Of 3 Or Less.

TANDEM

ITEM #: SPECIFICATIONS | GRADES | LIST PRICES:

ADD-A-SEAT

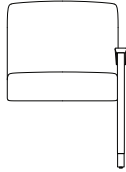

		Overall: 21.75"w 24"d 34"h		Arm: 25"h		COM: 2.75 yds.							
		Seat: 20"w 19"d 18.5"h		Weight: 50 lbs.		COL: n/a							
COM	COL	1	2	3	4	5	6	7	8	9	10	L1	L2
1881	N/A	1095	1164	1233	1302	1370	1439	1508	1576	1645	1714	N/A	N/A
<i>Closed Back / Tight Seat & Back / Removable Upholstery / 350 lb. Weight Capacity</i>													
1881-R	N/A	268	351	433	516	598	681	770	859	948	1037	N/A	N/A
<i>Replacement Upholstery Covers</i>													

ADD-A-SEAT / ACCEPTS SEAT ON RIGHT

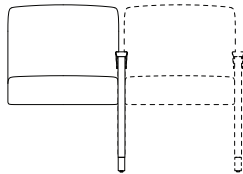

		Overall: 21.75"w 24"d 34"h		Arm: 25"h		COM: 2.75 yds.							
		Seat: 20"w 19"d 18.5"h		Weight: 50 lbs.		COL: n/a							
COM	COL	1	2	3	4	5	6	7	8	9	10	L1	L2
1881-C	N/A	1095	1164	1233	1302	1370	1439	1508	1576	1645	1714	N/A	N/A
<i>Closed Back / Tight Seat & Back / Removable Upholstery / 350 lb. Weight Capacity</i>													
1881-R	N/A	268	351	433	516	598	681	770	859	948	1037	N/A	N/A
<i>Replacement Upholstery Covers</i>													

ADD-A-SEAT / ACCEPTS TABLE ON RIGHT

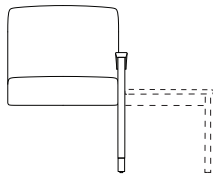

		Overall: 21.75"w 24"d 34"h		Arm: 25"h		COM: 2.75 yds.							
		Seat: 20"w 19"d 18.5"h		Weight: 50 lbs.		COL: n/a							
COM	COL	1	2	3	4	5	6	7	8	9	10	L1	L2
1881-T	N/A	1095	1164	1233	1302	1370	1439	1508	1576	1645	1714	N/A	N/A
<i>Closed Back / Tight Seat & Back / Removable Upholstery / 350 lb. Weight Capacity</i>													
1881-R	N/A	268	351	433	516	598	681	770	859	948	1037	N/A	N/A
<i>Replacement Upholstery Covers</i>													

DESCRIPTION:

- Upholstery Frames: Steel, Plywood & Hardwood
- Seat: High Density Polyurethane Foam Over Strap Webbing
- Back: High Density Polyurethane Foam Over Plywood
- Upholstered Covers: Attached w/ Velcro / Removable For Maintenance
- Exposed Black Polyurethane Arm Caps Standard
- Exposed Black Polyester Legs Standard: Removable For Maintenance / Wallsaver Legs
- Antimicrobial Moisture Barrier Fully Encapsulates Seat & Back
- Leather Upholstery Not Available
- Adjustable Height Leveling Glides Standard
- Lifetime Warranty

OPTIONS:

- EPAC-1 Polyester Arm Cap (Specify Color)\$195 Each
- Specify Exposed Polyester Leg Finish (See Page 7)
- Table & Connecting Tables Available (See Facelift Evolve Guest/Tandem/Tables)

NOTE: All Seating Configurations Are Viewed From Left To Right Facing. Please Attach A Layout Showing Seating Configuration w/ Your Order. Assembled Units Must Be Shipped In Configurations Of 3 Or Less.

BARIATRIC / TANDEM

ITEM #:

SPECIFICATIONS | GRADES | LIST PRICES:

FULLY UPHOLSTERED BARIATRIC CHAIR

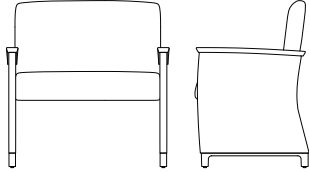

Overall: 33.5"w 24"d 34"h **Arm:** 25"h **COM:** 4.25 yds.
Seat: 30"w 19"d 18.5"h **Weight:** 65 lbs. **COL:** n/a

COM	COL	1	2	3	4	5	6	7	8	9	10	L1	L2
1703	N/A	1830	1940	2050	2160	2270	2380	2490	2600	2710	2820	N/A	N/A
<i>Closed Back / Tight Seat & Back / Removable Upholstery / 500 lb. Weight Capacity</i>													
1882													
148	N/A	404	536	668	800	932	1064	1196	1328	1460	1592	N/A	N/A
<i>Replacement Upholstery Covers</i>													

FULLY UPHOLSTERED BARIATRIC CHAIR / ACCEPTS CHAIR ON RIGHT

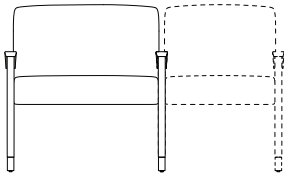

Overall: 33.5"w 24"d 34"h **Arm:** 25"h **COM:** 4.25 yds.
Seat: 30"w 19"d 18.5"h **Weight:** 65 lbs. **COL:** n/a

COM	COL	1	2	3	4	5	6	7	8	9	10	L1	L2
1703	N/A	1830	1940	2050	2160	2270	2380	2490	2600	2710	2820	N/A	N/A
<i>Closed Back / Tight Seat & Back / Removable Upholstery / 500 lb. Weight Capacity</i>													
1882-C													
148	N/A	404	536	668	800	932	1064	1196	1328	1460	1592	N/A	N/A
<i>Replacement Upholstery Covers</i>													

FULLY UPHOLSTERED BARIATRIC CHAIR / ACCEPTS TABLE ON RIGHT

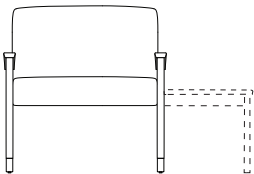

Overall: 33.5"w 24"d 34"h **Arm:** 25"h **COM:** 4.25 yds.
Seat: 30"w 19"d 18.5"h **Weight:** 65 lbs. **COL:** n/a

COM	COL	1	2	3	4	5	6	7	8	9	10	L1	L2
1703	N/A	1830	1940	2050	2160	2270	2380	2490	2600	2710	2820	N/A	N/A
<i>Closed Back / Tight Seat & Back / Removable Upholstery / 500 lb. Weight Capacity</i>													
1882-T													
148	N/A	404	536	668	800	932	1064	1196	1328	1460	1592	N/A	N/A
<i>Replacement Upholstery Covers</i>													

DESCRIPTION:

- Upholstery Frames: Steel, Plywood & Hardwood
- Seat: High Density Polyurethane Foam Over Strap Webbing
- Back: High Density Polyurethane Foam Over Plywood
- Upholstered Covers: Attached w/ Velcro / Removable For Maintenance
- Exposed Black Polyurethane Arm Caps Standard
- Exposed Black Polyester Legs Standard: Removable For Maintenance / Wallsaver Legs
- Antimicrobial Moisture Barrier Fully Encapsulates Seat & Back
- Leather Upholstery Not Available
- Adjustable Height Leveling Glides Standard
- Lifetime Warranty

OPTIONS:

- EPAC-1 Polyester Arm Cap (Specify Color)\$195 Each
- Specify Exposed Polyester Leg Finish (See Page 7)
- Table & Connecting Tables Available (See Facelift Evolve Guest/Tandem/Tables)

NOTE: All Seating Configurations Are Viewed From Left To Right Facing. Please Attach A Layout Showing Seating Configuration w/ Your Order. Assembled Units Must Be Shipped In Configurations Of 3 Or Less.

BARIATRIC / TANDEM

ITEM #:

SPECIFICATIONS | GRADES | LIST PRICES:

BARIATRIC ADD-A-SEAT

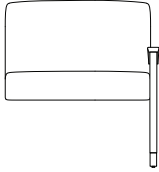

Overall: 31.75"w 24"d 34"h **Arm:** 25"h **COM:** 3.25 yds.
Seat: 30"w 19"d 18.5"h **Weight:** 62 lbs. **COL:** n/a

COM	COL	1	2	3	4	5	6	7	8	9	10	L1	L2
1883	N/A	1392	1468	1543	1619	1695	1770	1846	1921	1997	2073	N/A	N/A
<i>Closed Back / Tight Seat & Back / Removable Upholstery / 500 lb. Weight Capacity</i>													
1883-R	N/A	300	391	481	572	663	754	844	935	1026	1116	N/A	N/A
<i>Replacement Upholstery Covers</i>													

BARIATRIC ADD-A-SEAT / ACCEPTS SEAT ON RIGHT

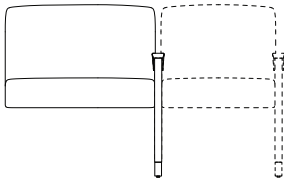

Overall: 31.75"w 24"d 34"h **Arm:** 25"h **COM:** 3.25 yds.
Seat: 30"w 19"d 18.5"h **Weight:** 62 lbs. **COL:** n/a

COM	COL	1	2	3	4	5	6	7	8	9	10	L1	L2
1883-C	N/A	1392	1468	1543	1619	1695	1770	1846	1921	1997	2073	N/A	N/A
<i>Closed Back / Tight Seat & Back / Removable Upholstery / 500 lb. Weight Capacity</i>													
1883-R	N/A	300	391	481	572	663	754	844	935	1026	1116	N/A	N/A
<i>Replacement Upholstery Covers</i>													

BARIATRIC ADD-A-SEAT / ACCEPTS TABLE ON RIGHT

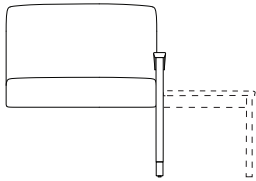

Overall: 31.75"w 24"d 34"h **Arm:** 25"h **COM:** 3.25 yds.
Seat: 30"w 19"d 18.5"h **Weight:** 62 lbs. **COL:** n/a

COM	COL	1	2	3	4	5	6	7	8	9	10	L1	L2
1883-T	N/A	1392	1468	1543	1619	1695	1770	1846	1921	1997	2073	N/A	N/A
<i>Closed Back / Tight Seat & Back / Removable Upholstery / 500 lb. Weight Capacity</i>													
1883-R	N/A	300	391	481	572	663	754	844	935	1026	1116	N/A	N/A
<i>Replacement Upholstery Covers</i>													

DESCRIPTION:

- Upholstery Frames: Steel, Plywood & Hardwood
- Seat: High Density Polyurethane Foam Over Strap Webbing
- Back: High Density Polyurethane Foam Over Plywood
- Upholstered Covers: Attached w/ Velcro / Removable For Maintenance
- Exposed Black Polyurethane Arm Caps Standard
- Exposed Black Polyester Legs Standard: Removable For Maintenance / Wallsaver Legs
- Antimicrobial Moisture Barrier Fully Encapsulates Seat & Back
- Leather Upholstery Not Available
- Adjustable Height Leveling Glides Standard
- Lifetime Warranty

OPTIONS:

- EPAC-1 Polyester Arm Cap (Specify Color)\$195 Each
- Specify Exposed Polyester Leg Finish (See Page 7)
- Table & Connecting Tables Available (See Facelift Evolve Guest/Tandem/Tables)

NOTE: All Seating Configurations Are Viewed From Left To Right Facing. Please Attach A Layout Showing Seating Configuration w/ Your Order. Assembled Units Must Be Shipped In Configurations Of 3 Or Less.

GUEST / TANDEM

ITEM #:

SPECIFICATIONS | GRADES | LIST PRICES:

FULLY UPHOLSTERED TWO PLACE SOFA

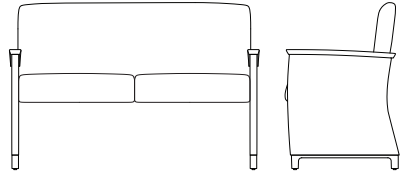

1884

1884-R

Overall: 51.5"w 24"d 34"h **Arm:** 25"h **COM:** 5.5 yds.
Seat: 48"w 19"d 18.5"h **Weight:** 75 lbs. **COL:** n/a

COM	COL	1	2	3	4	5	6	7	8	9	10	L1	L2
2112	N/A	2285	2429	2574	2718	2862	3007	3151	3295	3440	3584	N/A	N/A
<i>Closed Back / Tight Seat & Back / Removable Upholstery / 750 lb. Weight Capacity</i>													
182	N/A	519	692	865	1038	1212	1385	1558	1731	1904	2077	N/A	N/A
<i>Replacement Upholstery Covers</i>													

FULLY UPHOLSTERED TWO PLACE SOFA / ACCEPTS CHAIR ON RIGHT

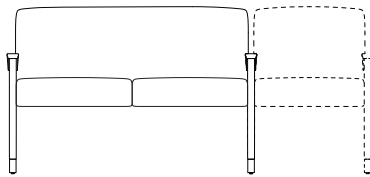

1884-C

1884-R

Overall: 51.5"w 24"d 34"h **Arm:** 25"h **COM:** 5.5 yds.
Seat: 48"w 19"d 18.5"h **Weight:** 75 lbs. **COL:** n/a

COM	COL	1	2	3	4	5	6	7	8	9	10	L1	L2
2112	N/A	2285	2429	2574	2718	2862	3007	3151	3295	3440	3584	N/A	N/A
<i>Closed Back / Tight Seat & Back / Removable Upholstery / 750 lb. Weight Capacity</i>													
182	N/A	519	692	865	1038	1212	1385	1558	1731	1904	2077	N/A	N/A
<i>Replacement Upholstery Covers</i>													

FULLY UPHOLSTERED TWO PLACE SOFA / ACCEPTS TABLE ON RIGHT

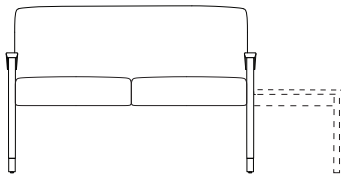

1884-T

1884-R

Overall: 51.5"w 24"d 34"h **Arm:** 25"h **COM:** 5.5 yds.
Seat: 48"w 19"d 18.5"h **Weight:** 75 lbs. **COL:** n/a

COM	COL	1	2	3	4	5	6	7	8	9	10	L1	L2
2112	N/A	2285	2429	2574	2718	2862	3007	3151	3295	3440	3584	N/A	N/A
<i>Closed Back / Tight Seat & Back / Removable Upholstery / 750 lb. Weight Capacity</i>													
182	N/A	519	692	865	1038	1212	1385	1558	1731	1904	2077	N/A	N/A
<i>Replacement Upholstery Covers</i>													

DESCRIPTION:

- Upholstery Frames: Steel, Plywood & Hardwood
- Seat: High Density Polyurethane Foam Over Strap Webbing
- Back: High Density Polyurethane Foam Over Plywood
- Upholstered Covers: Attached w/ Velcro / Removable For Maintenance
- Exposed Black Polyurethane Arm Caps Standard
- Exposed Black Polyester Legs Standard: Removable For Maintenance / Wallsaver Legs
- Antimicrobial Moisture Barrier Fully Encapsulates Seat & Back
- Leather Upholstery Not Available
- Adjustable Height Leveling Glides Standard
- Lifetime Warranty

OPTIONS:

- EPAC-1 Polyester Arm Cap (Specify Color)\$195 Each
- Specify Exposed Polyester Leg Finish (See Page 7)
- Table & Connecting Tables Available (See Facelift Evolve Guest/Tandem/Tables)

NOTE: All Seating Configurations Are Viewed From Left To Right Facing. Please Attach A Layout Showing Seating Configuration w/ Your Order. Assembled Units Must Be Shipped In Configurations Of 3 Or Less.

GUEST / TANDEM

ITEM #:

SPECIFICATIONS | GRADES | LIST PRICES:

TWO PLACE ADD-A-SEAT

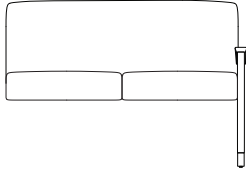

Overall: 49.75"w 24"d 34"h **Arm:** 25"h **COM:** 4.5 yds.
Seat: 48"w 19"d 18.5"h **Weight:** 72 lbs. **COL:** n/a

COM	COL	1	2	3	4	5	6	7	8	9	10	L1	L2
1885	N/A	1166	1283	1400	1517	1634	1750	1867	1984	2101	2218	N/A	N/A
<i>Closed Back / Tight Seat & Back / Removable Upholstery / 750 lb. Weight Capacity</i>													
1885-R	N/A	425	566	706	846	986	1126	1267	1407	1547	1687	N/A	N/A
<i>Replacement Upholstery Covers</i>													

TWO PLACE ADD-A-SEAT / ACCEPTS SEAT ON RIGHT

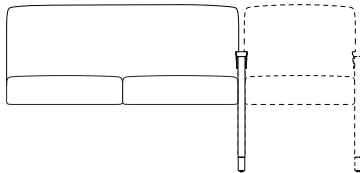

Overall: 49.75"w 24"d 34"h **Arm:** 25"h **COM:** 4.5 yds.
Seat: 48"w 19"d 18.5"h **Weight:** 72 lbs. **COL:** n/a

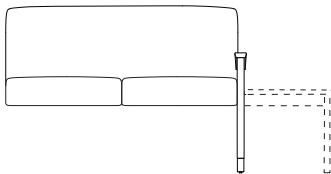

COM	COL	1	2	3	4	5	6	7	8	9	10	L1	L2
1885-C	N/A	1166	1283	1400	1517	1634	1750	1867	1984	2101	2218	N/A	N/A
<i>Closed Back / Tight Seat & Back / Removable Upholstery / 750 lb. Weight Capacity</i>													
1885-R	N/A	425	566	706	846	986	1126	1267	1407	1547	1687	N/A	N/A
<i>Replacement Upholstery Covers</i>													

TWO PLACE ADD-A-SEAT / ACCEPTS TABLE ON RIGHT



Overall: 49.75"w 24"d 34"h **Arm:** 25"h **COM:** 4.5 yds.
Seat: 48"w 19"d 18.5"h **Weight:** 72 lbs. **COL:** n/a

COM	COL	1	2	3	4	5	6	7	8	9	10	L1	L2
1885-T	N/A	1166	1283	1400	1517	1634	1750	1867	1984	2101	2218	N/A	N/A
<i>Closed Back / Tight Seat & Back / Removable Upholstery / 750 lb. Weight Capacity</i>													
1885-R	N/A	425	566	706	846	986	1126	1267	1407	1547	1687	N/A	N/A
<i>Replacement Upholstery Covers</i>													

ARM CAPS / COVERS	OPTION #:	SPECIFICATIONS LIST PRICES AVAILABILITY:
<p data-bbox="86 178 292 210">POLYESTER ARM CAPS</p> 	<p data-bbox="570 262 617 294">EPAC-1</p>	<p data-bbox="570 178 828 210"><i>Overall: 2.75"w 22.5"d 1.125"h</i></p> <hr/> <p data-bbox="570 262 844 325"> \$195 Each - POLYESTER <i>Polyester Arm Cap (Specify Exposed)</i> </p> <p data-bbox="570 367 974 399"><i>Available: Facelift Evolve Fully Upholstered Collection</i></p>
<p data-bbox="86 640 292 672">CONTRASTING COVERS</p> 	<p data-bbox="570 724 617 756">CC</p>	<p data-bbox="570 640 682 672"><i>Overall: N/A</i></p> <hr/> <p data-bbox="570 724 1477 829"> \$129 <i>NOTE: If Two Or More Upholsteries Or Leathers Are Used On Any Piece Of Furniture, Then A Contrast Charge Will Apply Per Order. When Using Trinity Upholstery, The Higher Priced Upholstery Grade Will Be Used In Pricing, Unless It's Trinity Leather With Fabric Contrast Welt, Or COM With Trinity Contrast Welt, Then Contact Customer Service For Pricing.</i> </p> <p data-bbox="570 871 974 903"><i>Available: Facelift Evolve Fully Upholstered Collection</i></p>

T R I N I T Y

Established 1984



T R I N I T Y

P.O. Box 150
Trinity, NC 27370
T 336.472.6660 F 336.475.0037 TF 855.311.6660
sales@trinityfurniture.com www.trinityfurniture.com